

GenX3™ 600V IGBT with Diode

IXGR48N60C3D1

(Electrically Isolated Back Surface)

High Speed PT IGBTs for
40-100kHz Switching

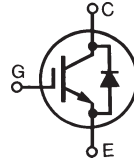

$V_{CES} = 600V$
 $I_{C25} = 56A$
 $V_{CE(sat)} \leq 2.7V$
 $t_{fi(typ)} = 38ns$

Symbol	Test Conditions	Maximum Ratings	
V_{CES}	$T_J = 25^\circ C$ to $150^\circ C$	600	V
V_{CGR}	$T_J = 25^\circ C$ to $150^\circ C$, $R_{GE} = 1M\Omega$	600	V
V_{GES}	Continuous	± 20	V
V_{GEM}	Transient	± 30	V
I_{C25}	$T_C = 25^\circ C$	56	A
I_{C110}	$T_C = 110^\circ C$	26	A
I_{D110}	$T_C = 110^\circ C$	27	A
I_{CM}	$T_C = 25^\circ C$, 1ms	230	A
I_A	$T_C = 25^\circ C$	30	A
E_{AS}	$T_C = 25^\circ C$	300	mJ
SSOA (RBSOA)	$V_{GE} = 15V$, $T_{VJ} = 125^\circ C$, $R_G = 3\Omega$ Clamped Inductive Load	$I_{CM} = 100$ @ $V_{CE} \leq 600$	A V
P_C	$T_C = 25^\circ C$	125	W
T_J		-55 ... +150	$^\circ C$
T_{JM}		150	$^\circ C$
T_{stg}		-55 ... +150	$^\circ C$
T_L	1.6mm (0.062 in.) from Case for 10s	300	$^\circ C$
T_{SOLD}	Plastic Body for 10 Seconds	260	$^\circ C$
V_{ISOL}	50/60 Hz RMS, $t = 1min$	2500	V~
F_C	Mounting Force	20..120 / 4.5..27	N/lb.
Weight		5	g

ISOPLUS 247™

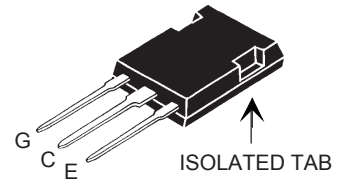

G = Gate C = Collector
E = Emitter

Features

- Silicon Chip on Direct-Copper Bond (DCB) Substrate
 - UL Recognized Package
 - Isolated Mounting Surface
 - 2500V Electrical Isolation
- Avalanche Rated
- Square RBSOA
- Anti-Parallel Ultra Fast Diode
- Fast Switching
- International Standard Package

Advantages

- High Power Density
- Low Gate Drive Requirement

Applications

- High Frequency Power Inverters
- UPS
- Motor Drives
- SMPS
- PFC Circuits
- Battery Chargers
- Welding Machines
- Lamp Ballasts

Symbol	Test Conditions	Characteristic Values ($T_J = 25^\circ C$, Unless Otherwise Specified)		
		Min.	Typ.	Max.
$V_{GE(th)}$	$I_C = 250\mu A$, $V_{CE} = V_{GE}$	3.0		5.5 V
I_{CES}	$V_{CE} = V_{CES}$ $V_{GE} = 0V$ $T_J = 125^\circ C$			300 μA 1.75 mA
I_{GES}	$V_{CE} = 0V$, $V_{GE} = \pm 20V$			± 100 nA
$V_{CE(sat)}$	$I_C = 30A$, $V_{GE} = 15V$, Note 1 $T_J = 125^\circ C$		2.3 1.8	2.7 V V

Symbol	Test Conditions	Characteristic Values		
		(T _J = 25°C, Unless Otherwise Specified)		
		Min.	Typ.	Max.
g_{fs}	I _C = 30A V _{CE} = 10V, Note 1	20	30	S
C_{ies}	V _{CE} = 25V, V _{GE} = 0V, f = 1MHz		1960	pF
C_{oes}			220	pF
C_{res}			66	pF
Q_g	I _C = 30A, V _{GE} = 15V, V _{CE} = 0.5 • V _{CES}		77	nC
Q_{ge}			16	nC
Q_{gc}			32	nC
t_{d(on)}	Inductive Load, T _J = 25°C I _C = 30A, V _{GE} = 15V V _{CE} = 400V, R _G = 3Ω		19	ns
t_{ri}			26	ns
E_{on}			0.41	mJ
t_{d(off)}			60	ns
t_{fi}			38	ns
E_{off}			0.23	0.55 mJ
t_{d(on)}	Inductive Load, T _J = 125°C I _C = 30A, V _{GE} = 15V V _{CE} = 400V, R _G = 3Ω		19	ns
t_{ri}			26	ns
E_{on}			0.65	mJ
t_{d(off)}			92	ns
t_{fi}			95	ns
E_{off}			0.57	mJ
R_{thJC}			1.0	°C/W
R_{thCS}		0.15		°C/W

ISOPLUS247 (IXGR) Outline

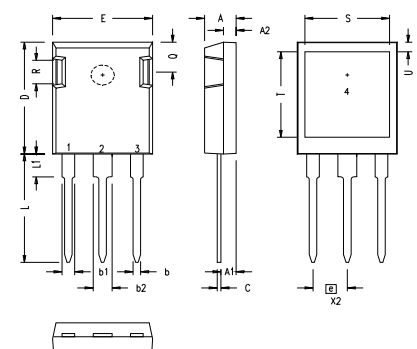

SYM	INCHES		MILLIMETERS	
	MIN	MAX	MIN	MAX
A	.190	.205	4.83	5.21
A1	.090	.100	2.29	2.54
A2	.075	.085	1.91	2.16
b	.045	.055	1.14	1.40
b1	.075	.084	1.91	2.13
b2	.115	.123	2.92	3.12
C	.024	.031	0.61	0.80
D	.819	.840	20.80	21.34
E	.620	.635	15.75	16.13
e	.215 BSC		5.45 BSC	
L	.780	.800	19.81	20.32
L1	.150	.170	3.81	4.32
Q	.220	.244	5.59	6.20
R	.170	.190	4.32	4.83
S	.520	.540	13.21	13.72
T	.620	.640	15.75	16.26
U	.065	.080	1.65	2.03

- 1 - GATE
- 2 - DRAIN (COLLECTOR)
- 3 - SOURCE (EMITTER)
- 4 - NO CONNECTION

NOTE: This drawing will meet all dimensions requirement of JEDEC outline TO-247AD except screw hole.

Symbol	Test Conditions	Characteristic Values		
		(T _J = 25°C, Unless Otherwise Specified)		
		Min.	Typ.	Max.
V_F	I _F = 30A, V _{GE} = 0V, Note 1	T _J = 25°C		2.7 V
I_{RM}	I _F = 30A, V _{GE} = 0V, -di _F /dt = 100A/μs, V _R = 100V	T _J = 100°C		4 A
t_{rr}		T _J = 100°C	100	
	I _F = 1A, -di/dt = 100A/μs; V _R = 30V		25	ns
R_{thJC}				1.5 °C/W

Note 1: Pulse test, t ≤ 300μs, Duty cycle, d ≤ 2 %.

**Fig. 1. Output Characteristics
@ 25°C**

**Fig. 2. Extended Output Characteristics
@ 25°C**

**Fig. 3. Output Characteristics
@ 125°C**

**Fig. 4. Dependence of $V_{CE(sat)}$ on
Junction Temperature**

**Fig. 5. Collector-to-Emitter Voltage
vs. Gate-to-Emitter Voltage**

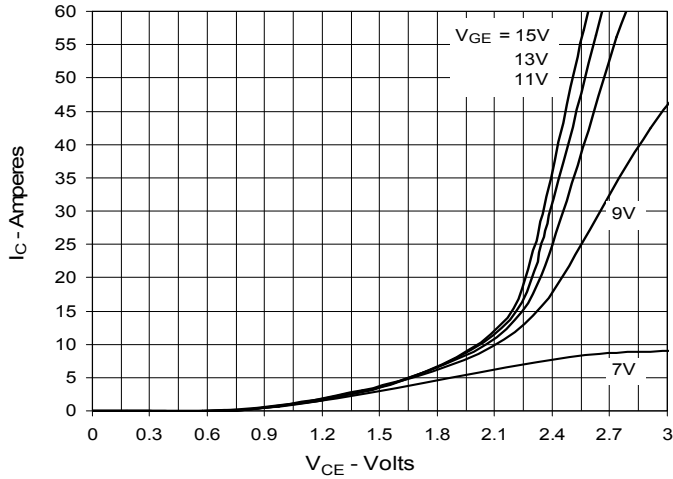
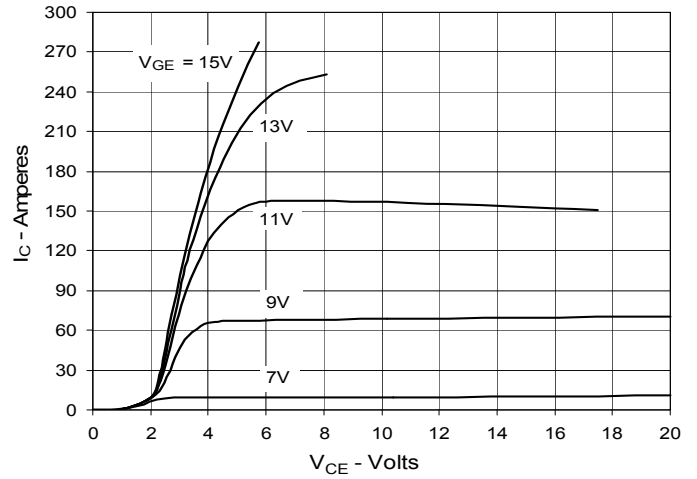
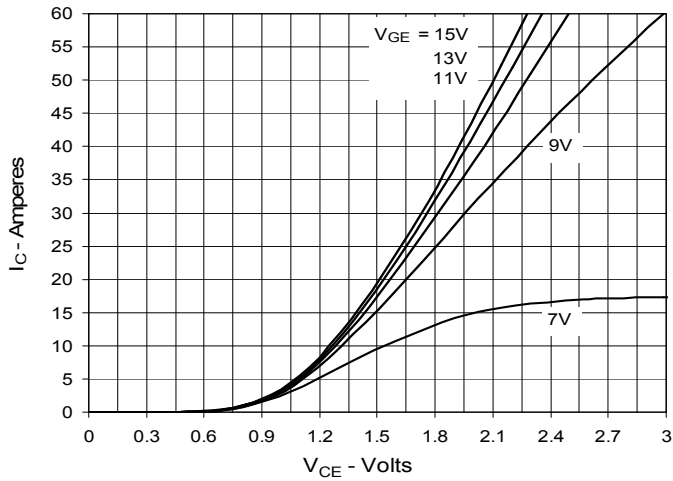
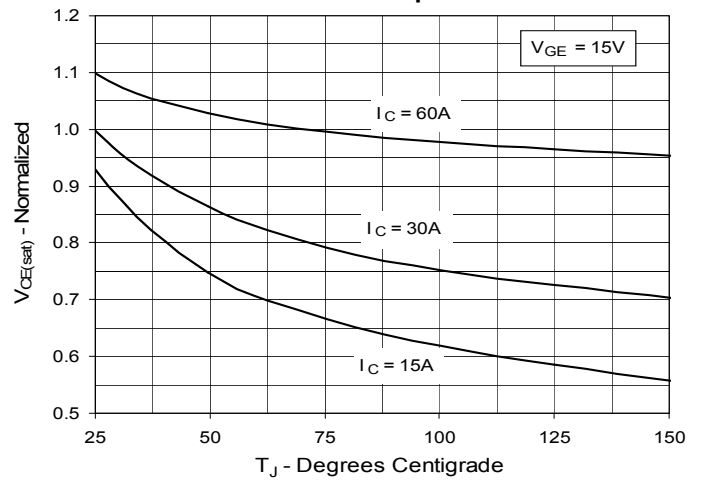
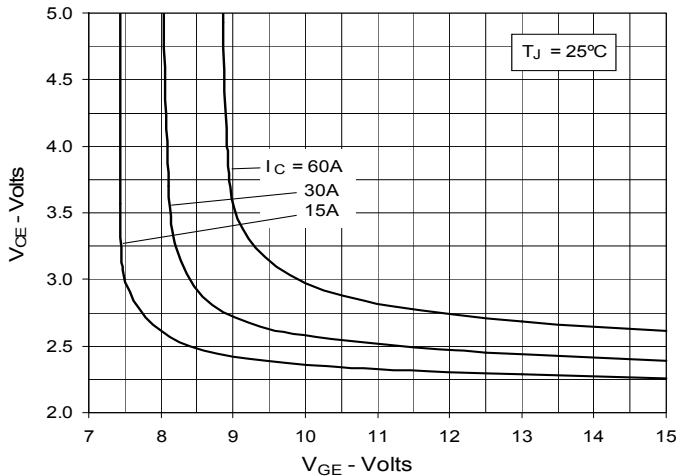
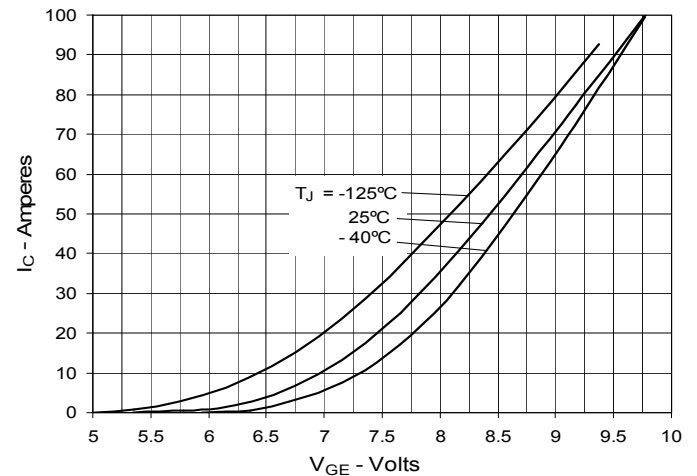
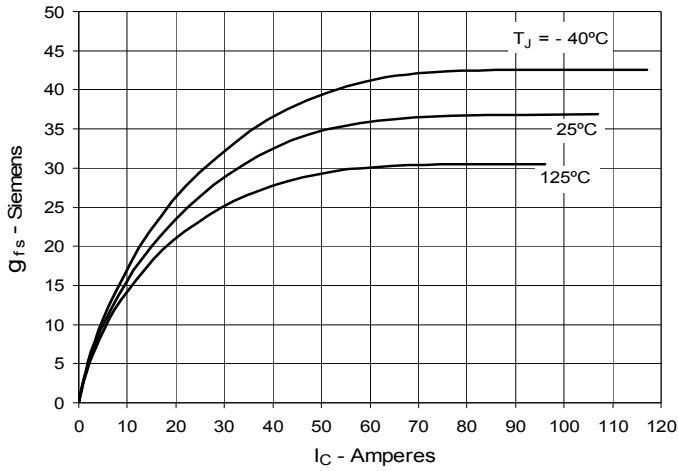
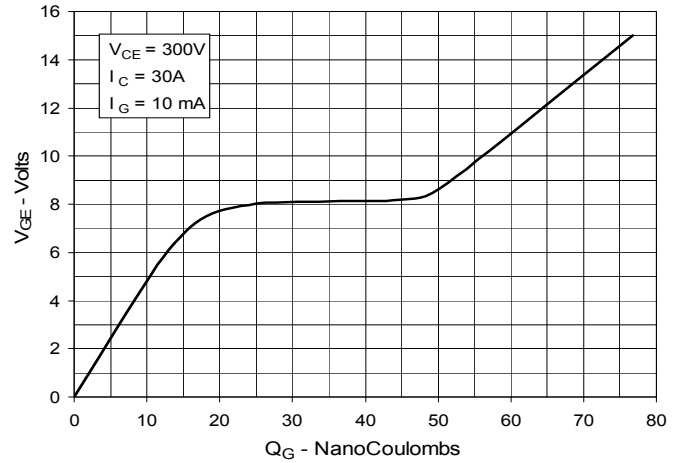
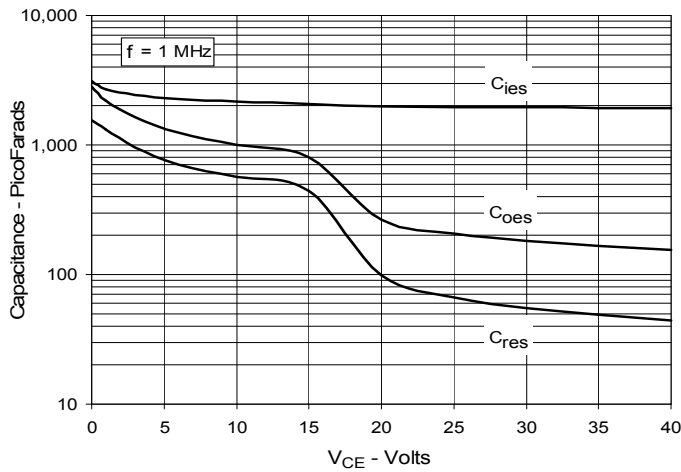
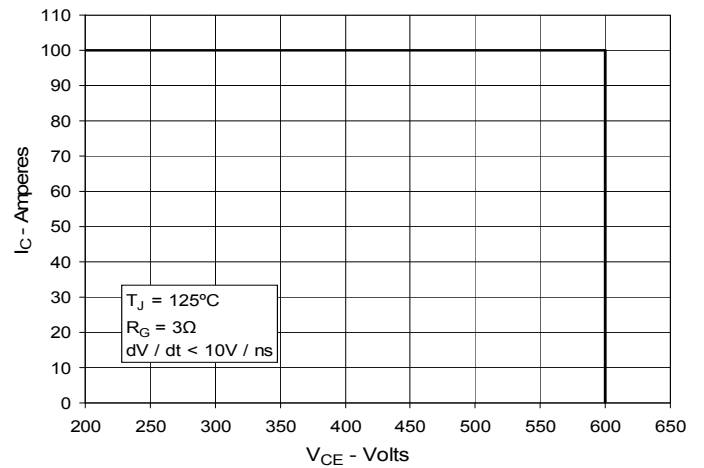
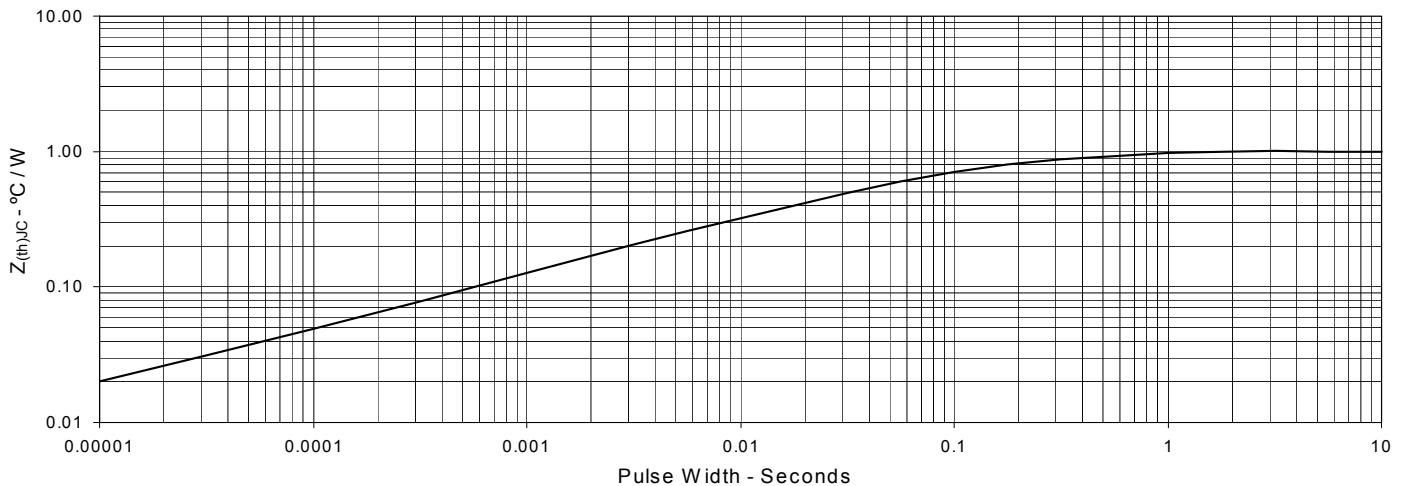
Fig. 6. Input Admittance

Fig. 7. Transconductance

Fig. 8. Gate Charge

Fig. 9. Capacitance

Fig. 10. Reverse-Bias Safe Operating Area

Fig. 11. Maximum Transient Thermal Impedance

**Fig. 12. Inductive Switching
Energy Loss vs. Gate Resistance**

**Fig. 13. Inductive Switching
Energy Loss vs. Collector Current**

**Fig. 14. Inductive Switching
Energy Loss vs. Junction Temperature**

**Fig. 15. Inductive Turn-off
Switching Times vs. Gate Resistance**

**Fig. 16. Inductive Turn-off
Switching Times vs. Collector Current**

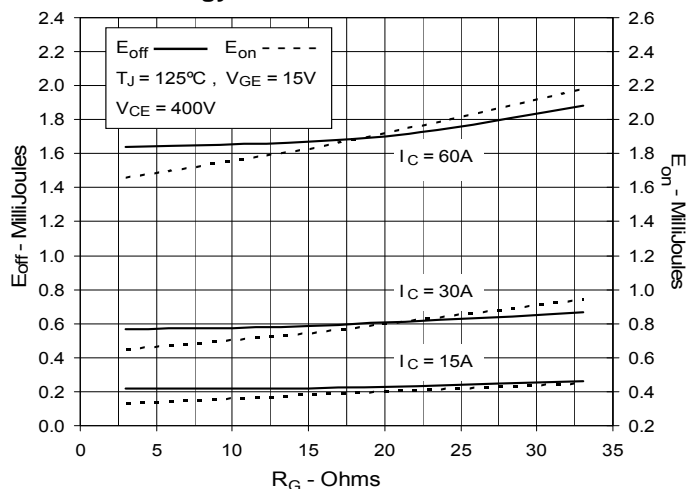
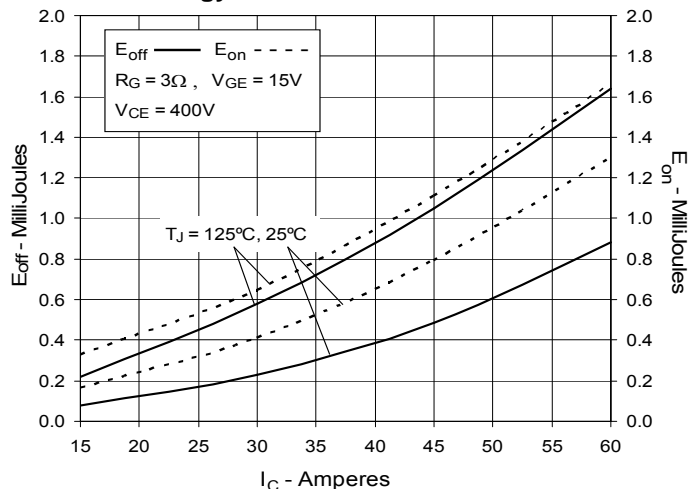
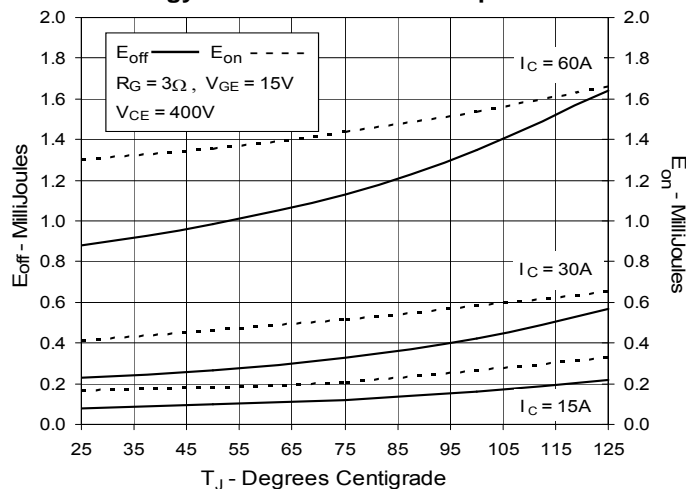
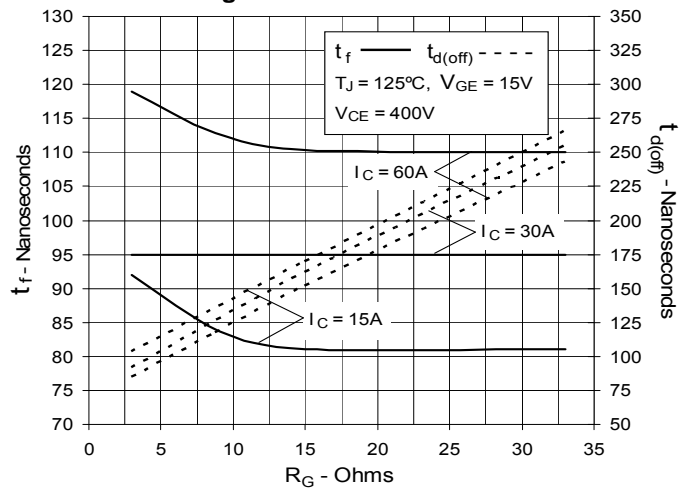
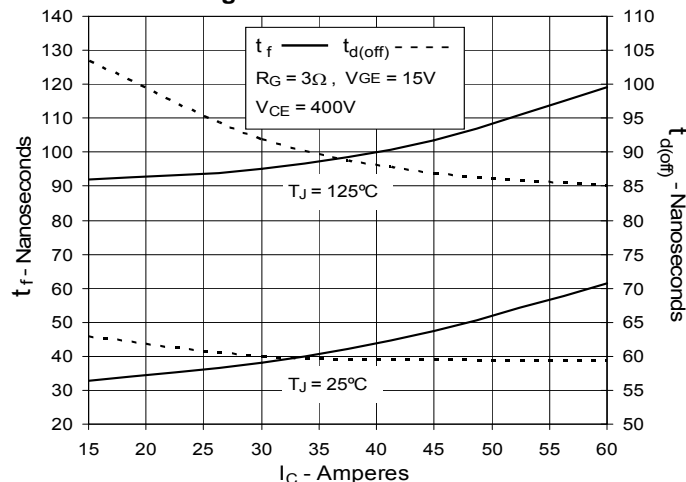
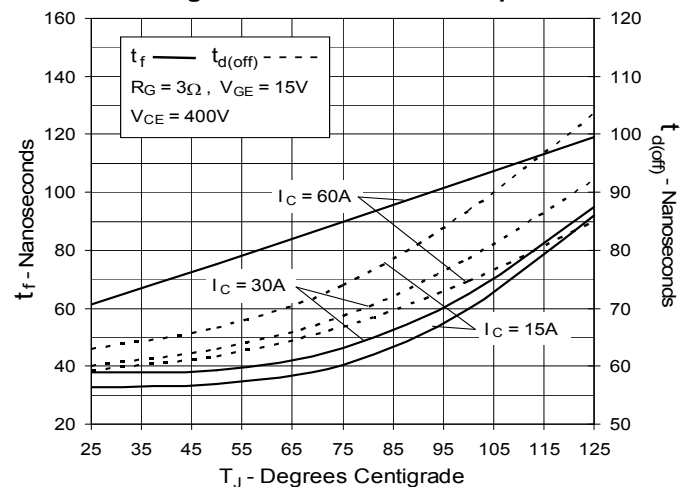
**Fig. 17. Inductive Turn-off
Switching Times vs. Junction Temperature**

Fig. 18. Inductive Turn-on Switching Times vs. Gate Resistance

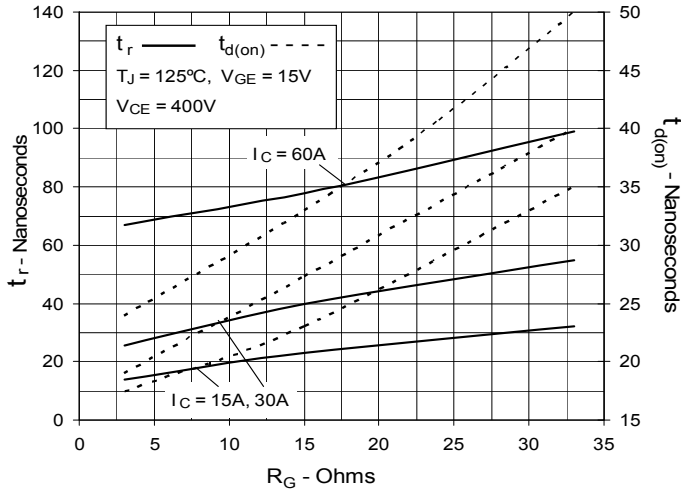

Fig. 19. Inductive Turn-on Switching Times vs. Collector Current

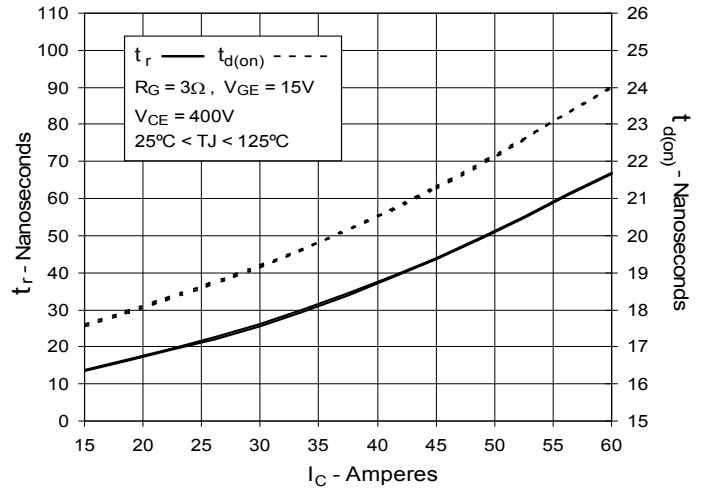
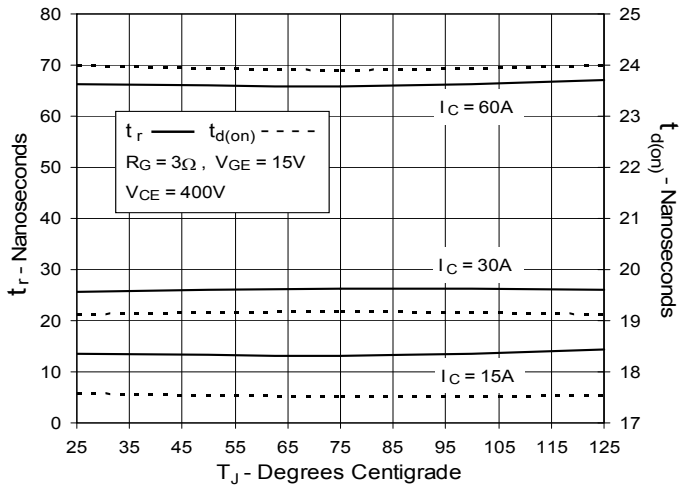

Fig. 20. Inductive Turn-on Switching Times vs. Junction Temperature



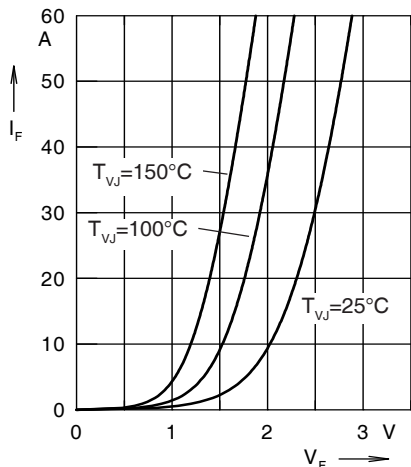

Fig. 21. Forward current I_F versus V_F

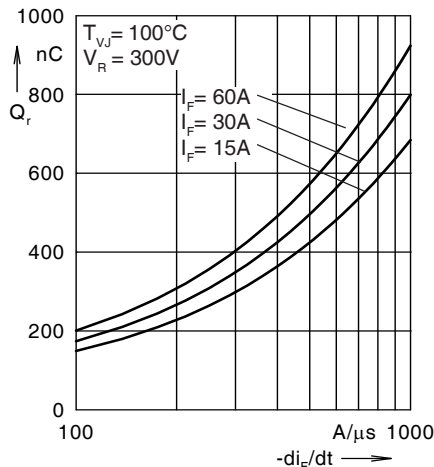

Fig. 22. Reverse recovery charge Q_r versus $-di_F/dt$

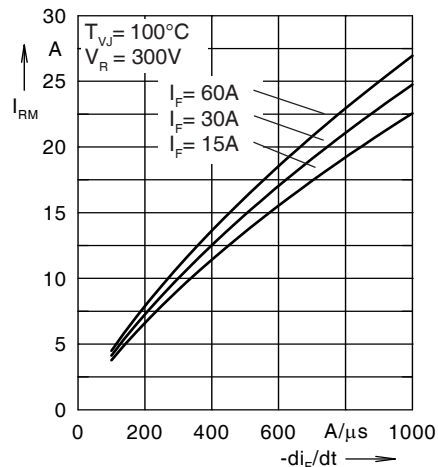

Fig. 23. Peak reverse current I_{RM} versus $-di_F/dt$

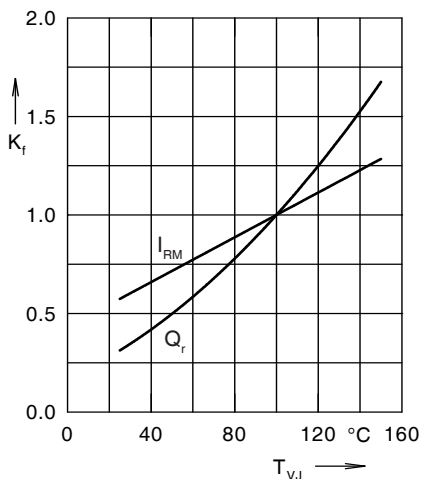

Fig. 24. Dynamic parameters Q_r , I_{RM} versus T_{VJ}

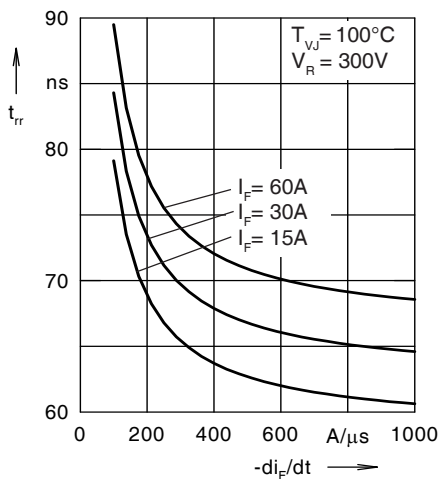

Fig. 25. Recovery time t_{rr} versus $-di_F/dt$

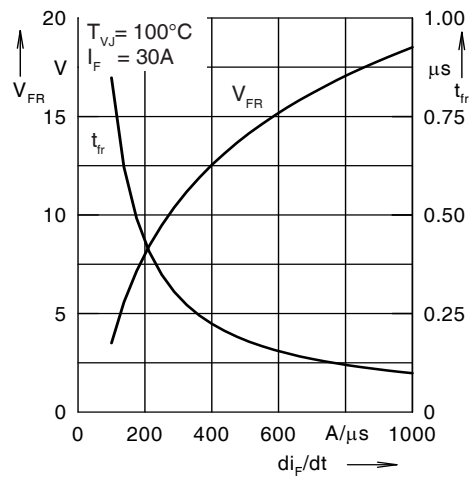

Fig. 26. Peak forward voltage V_{FR} and t_{fr} versus di_F/dt

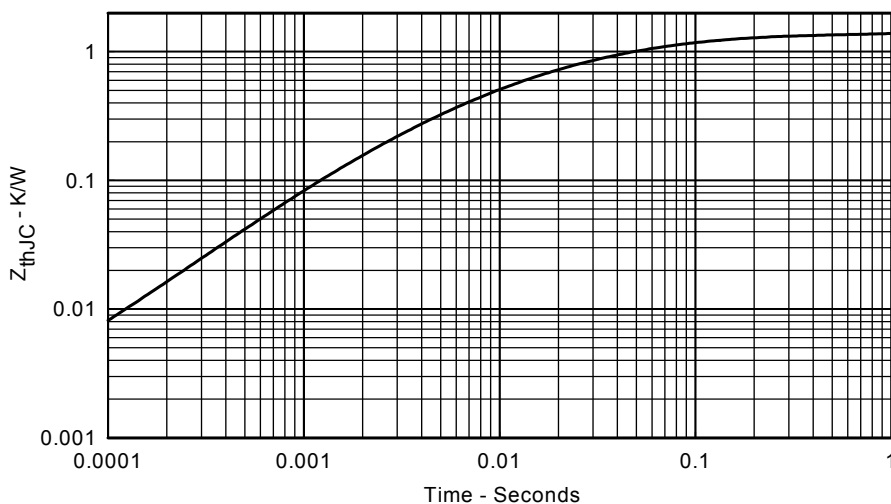

Fig. 27. Transient thermal resistance junction to case



Disclaimer Notice - Information furnished is believed to be accurate and reliable. However, users should independently evaluate the suitability of and test each product selected for their own applications. Littelfuse products are not designed for, and may not be used in, all applications. Read complete Disclaimer Notice at www.littelfuse.com/disclaimer-electronics.