

HiPerFAST™ IGBTs

B2-Class High Speed

w/ Diode

IXGA16N60B2D1
IXGP16N60B2D1
IXGH16N60B2D1

$V_{CES} = 600V$
 $I_{C110} = 16A$
 $V_{CE(sat)} \leq 1.95V$
 $t_{fi(typ)} = 70ns$

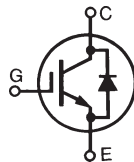

Symbol	Test Conditions	Maximum Ratings	
V_{CES}	$T_J = 25^\circ C$ to $150^\circ C$	600	V
V_{CGR}	$T_J = 25^\circ C$ to $150^\circ C$, $R_{GE} = 1M\Omega$	600	V
V_{GES}	Continuous	± 20	V
V_{GEM}	Transient	± 30	V
I_{C25}	$T_C = 25^\circ C$ (Chip Capability)	40	A
I_{C110}	$T_C = 110^\circ C$	16	A
I_{F110}	$T_C = 110^\circ C$	11	A
I_{CM}	$T_C = 25^\circ C$, 1ms	100	A
SSOA (RBSOA)	$V_{GE} = 15V$, $T_J = 125^\circ C$, $R_G = 22\Omega$ Clamped Inductive load	$I_{CM} = 32$ $V_{CE} \leq V_{CES}$	A
P_C	$T_C = 25^\circ C$	150	W
T_J		-55 ... +150	$^\circ C$
T_{JM}		150	$^\circ C$
T_{stg}		-55 ... +150	$^\circ C$
M_d	Mounting Torque (TO-220 & TO-247)	1.13/10	Nm/lb.in.
F_C	Mounting Force (TO-263)	10..65 / 2.2..14.6	N/lb.
T_L	Maximum Lead Temperature for Soldering	300	$^\circ C$
T_{SOLD}	1.6mm (0.062 in.) from Case for 10s	260	$^\circ C$
Weight	TO-263	2.5	g
	TO-220	3.0	g
	TO-247	6.0	g

Symbol	Test Conditions ($T_J = 25^\circ C$, Unless Otherwise Specified)	Characteristic Values		
		Min.	Typ.	Max.
$V_{GE(th)}$	$I_C = 250\mu A$, $V_{CE} = V_{GE}$	3.0		5.5 V
I_{CES}	$V_{CE} = V_{CES}$, $V_{GE} = 0V$ $T_J = 125^\circ C$			25 μA 1 mA
I_{GES}	$V_{CE} = 0V$, $V_{GE} = \pm 20V$			± 100 nA
$V_{CE(sat)}$	$I_C = 12A$, $V_{GE} = 15V$, Note1 $T_J = 125^\circ C$		1.65	1.95 V V

TO-263 AA (IXGA)

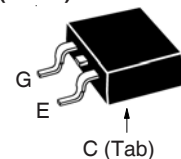

TO-220AB (IXGP)

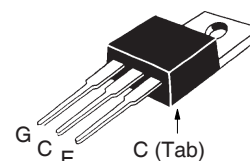

TO-247 (IXGH)

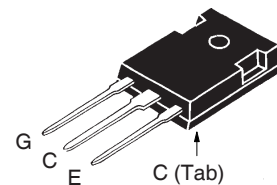

G = Gate C = Collector
 E = Emitter Tab = Collector

Features

- Optimized for Low Conduction and Switching Losses
- Square RBSOA
- Anti-Parallel Ultra Fast Diode
- International Standard Packages

Advantages

- High Power Density
- Low Gate Drive Requirement

Applications

- Power Inverters
- UPS
- Motor Drives
- SMPS
- PFC Circuits
- Battery Chargers
- Welding Machines
- Lamp Ballasts

Symbol	Test Conditions ($T_J = 25^\circ\text{C}$, Unless Otherwise Specified)	Characteristic Values		
		Min.	Typ.	Max.
g_{fs}	$I_C = 12\text{A}, V_{CE} = 10\text{V}$, Note 1	8		S
C_{ies} C_{oes} C_{res}	$V_{CE} = 25\text{V}, V_{GE} = 0\text{V}, f = 1\text{MHz}$		675	pF
			70	pF
			20	pF
$Q_{g(on)}$ Q_{ge} Q_{gc}	$I_C = 12\text{A}, V_{GE} = 15\text{V}, V_{CE} = 0.5 \cdot V_{CES}$		24	nC
			5	nC
			13	nC
$t_{d(on)}$ t_{ri} E_{on} $t_{d(off)}$ t_{fi} E_{off}	Inductive load, $T_J = 25^\circ\text{C}$ $I_C = 12\text{A}, V_{GE} = 15\text{V}$ $V_{CE} = 400\text{V}, R_G = 22\Omega$ Note 2		18	ns
			20	ns
			0.16	mJ
			73	ns
			70	ns
			0.12	0.22 mJ
$t_{d(on)}$ t_{ri} E_{on} $t_{d(off)}$ t_{fi} E_{off}	Inductive load, $T_J = 125^\circ\text{C}$ $I_C = 12\text{A}, V_{GE} = 15\text{V}$ $V_{CE} = 400\text{V}, R_G = 22\Omega$ Note 2		17	ns
			20	ns
			0.26	mJ
			140	ns
			125	ns
			0.38	mJ
R_{thJC} R_{thCK}	TO-220 TO-247		0.83	$^\circ\text{C/W}$
		0.50	$^\circ\text{C/W}$	
		0.21	$^\circ\text{C/W}$	

Reverse Diode (FRED)

Symbol	Test Conditions ($T_J = 25^\circ\text{C}$, Unless Otherwise Specified)	Characteristic Values		
		Min.	Typ.	Max.
V_F	$I_F = 10\text{A}, V_{GE} = 0\text{V}$, Note 1 $T_J = 125^\circ\text{C}$		1.7	3.0 V V
I_{RM} t_{rr} t_{rr}	$I_F = 12\text{A}, V_{GE} = 0\text{V}$, $-di_F/dt = 100\text{A}/\mu\text{s}, V_R = 100\text{V}, T_J = 125^\circ\text{C}$ $I_F = 1\text{A}, V_{GE} = 0\text{V}, -di_F/dt = 100\text{A}/\mu\text{s}, V_R = 30\text{V}$		2.5	A
			110	ns
			30	ns
R_{thJC}			2.5	$^\circ\text{C/W}$

Notes:

1. Pulse test, $t \leq 300\mu\text{s}$, duty cycle, $d \leq 2\%$.
2. Switching times & energy losses may increase for higher $V_{CE}(\text{Clamp})$, T_J or R_G .

IXYS Reserves the Right to Change Limits, Test Conditions, and Dimensions.

TO-263 (IXGA) Outline

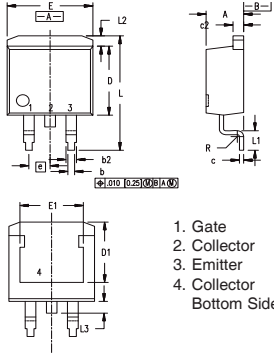

- 1. Gate
- 2. Collector
- 3. Emitter
- 4. Collector Bottom Side

Dim.	Millimeter		Inches	
	Min.	Max.	Min.	Max.
A	4.06	4.83	.160	.190
b	0.51	0.99	.020	.039
b2	1.14	1.40	.045	.055
c	0.40	0.74	.016	.029
c2	1.14	1.40	.045	.055
D	8.64	9.65	.340	.380
D1	8.00	8.89	.280	.320
E	9.65	10.41	.380	.405
E1	6.22	8.13	.270	.320
e	2.54	BSC	.100	BSC
L	14.61	15.88	.575	.625
L1	2.29	2.79	.090	.110
L2	1.02	1.40	.040	.055
L3	1.27	1.78	.050	.070
L4	0	0.13	0	.005

TO-220 (IXGP) Outline

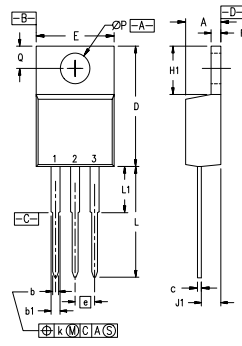

- Pins: 1 - Gate
2 - Collector
3 - Emitter

SYM	INCHES		MILLIMETERS	
	MIN	MAX	MIN	MAX
A	.170	.190	4.32	4.83
b	.025	.040	0.64	1.02
b1	.045	.065	1.15	1.65
c	.014	.022	0.35	0.56
D	.580	.630	14.73	16.00
E	.390	.420	9.91	10.66
e	.100 BSC		2.54 BSC	
F	.045	.055	1.14	1.40
H1	.230	.270	5.85	6.85
J1	.090	.110	2.29	2.79
k	0	.015	0	0.38
L	.500	.550	12.70	13.97
L1	.110	.230	2.79	5.84
ØP	.139	.161	3.53	4.08
Q	.100	.125	2.54	3.18

TO-247 (IXGH) AD Outline

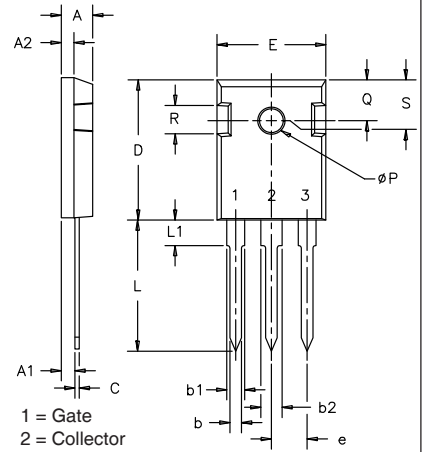

- 1 = Gate
- 2 = Collector
- 3 = Emitter

SYM	INCHES		MILLIMETERS	
	MIN	MAX	MIN	MAX
A	.185	.209	4.7	5.3
A1	.087	.102	2.2	2.54
A2	.059	.098	2.2	2.6
b	.040	.055	1.0	1.4
b1	.065	.084	1.65	2.13
b2	.113	.123	2.87	3.12
C	.016	.031	.4	.8
D	.819	.845	20.80	21.46
E	.610	.640	15.75	16.26
e	.215 BSC		5.45 BSC	
L	.780	.800	19.81	20.32
L1	.177		4.50	
ØP	.140	.144	3.55	3.65
Q	.212	.244	5.4	6.2
R	.170	.216	4.32	5.49
S	.242 BSC		6.15 BSC	

Fig. 1. Output Characteristics @ $T_J = 25^\circ\text{C}$

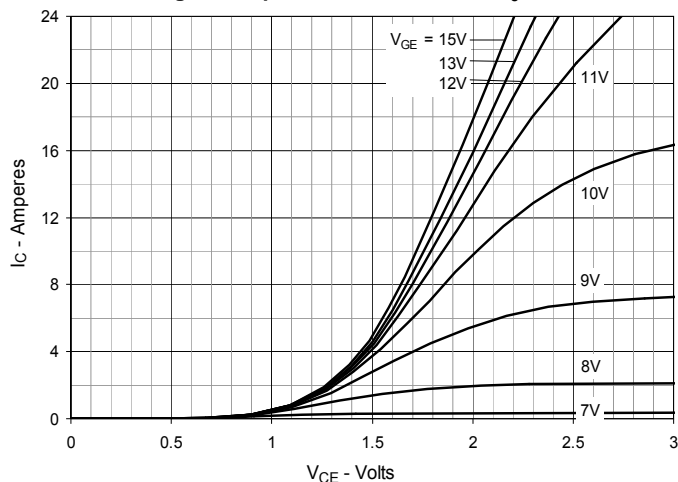

Fig. 2. Extended Output Characteristics @ $T_J = 25^\circ\text{C}$

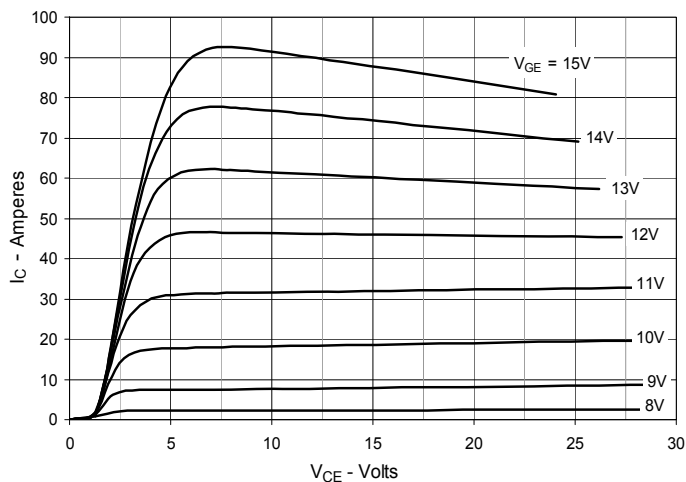

Fig. 3. Output Characteristics @ $T_J = 125^\circ\text{C}$

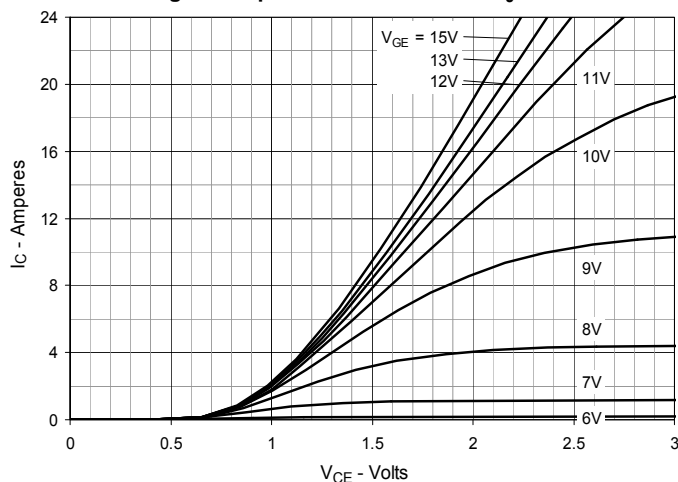

Fig. 4. Dependence of $V_{CE(sat)}$ on Junction Temperature

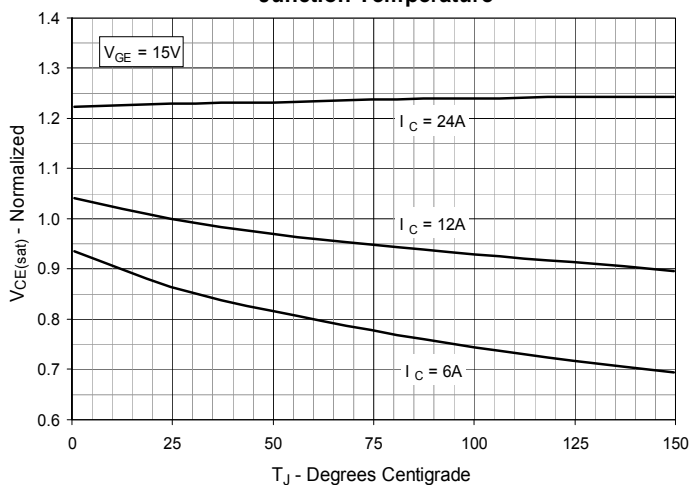

Fig. 5. Collector-to-Emitter Voltage vs. Gate-to-Emitter Voltage

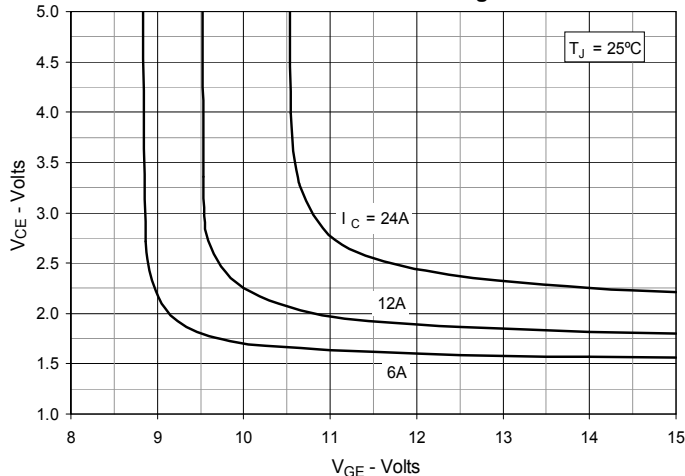

Fig. 6. Input Admittance

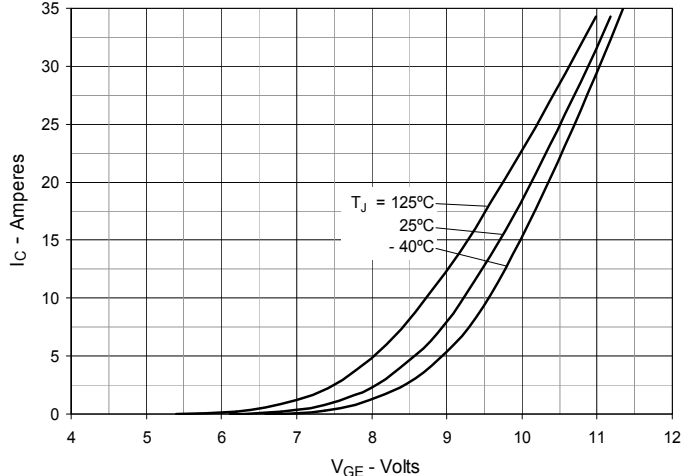

Fig. 7. Transconductance

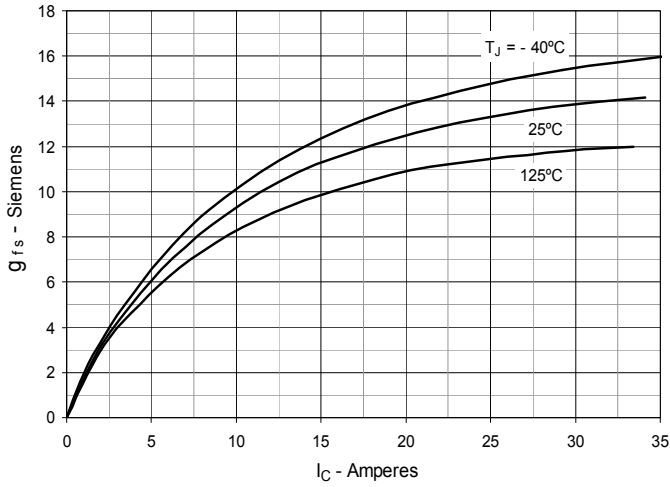

Fig. 8. Gate Charge

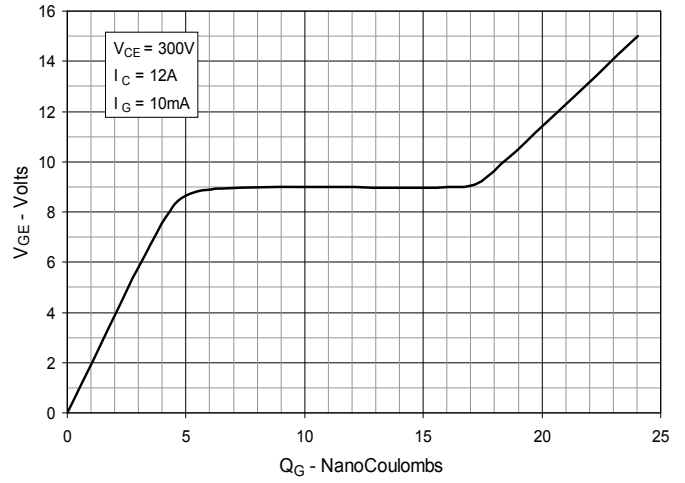

Fig. 9. Capacitance

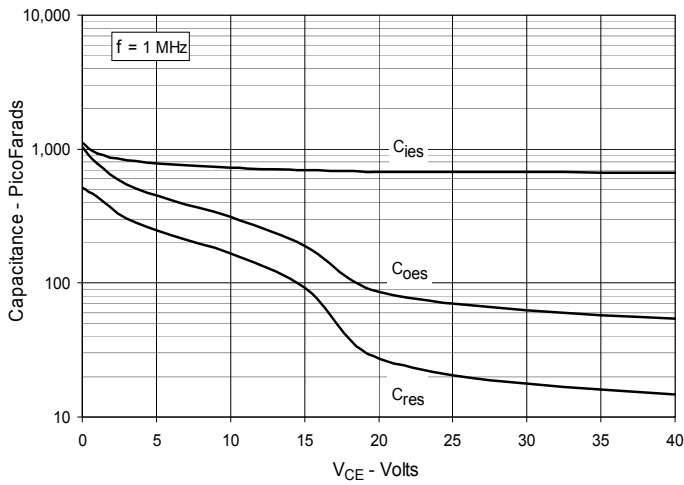

Fig. 10. Reverse-Bias Safe Operating Area

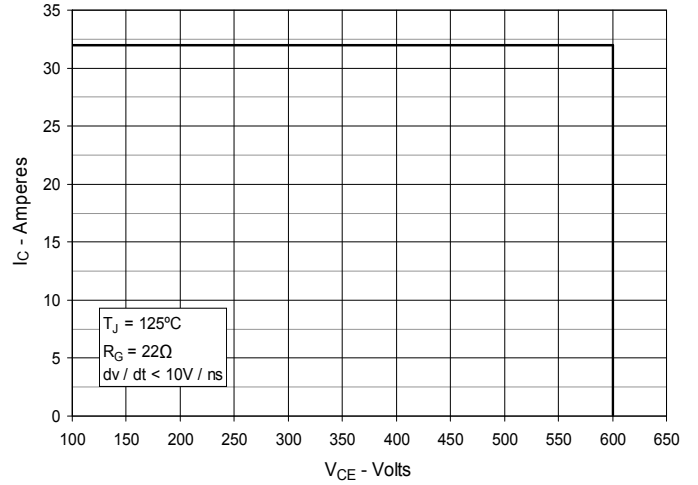

Fig. 11. Maximum Transient Thermal Impedance

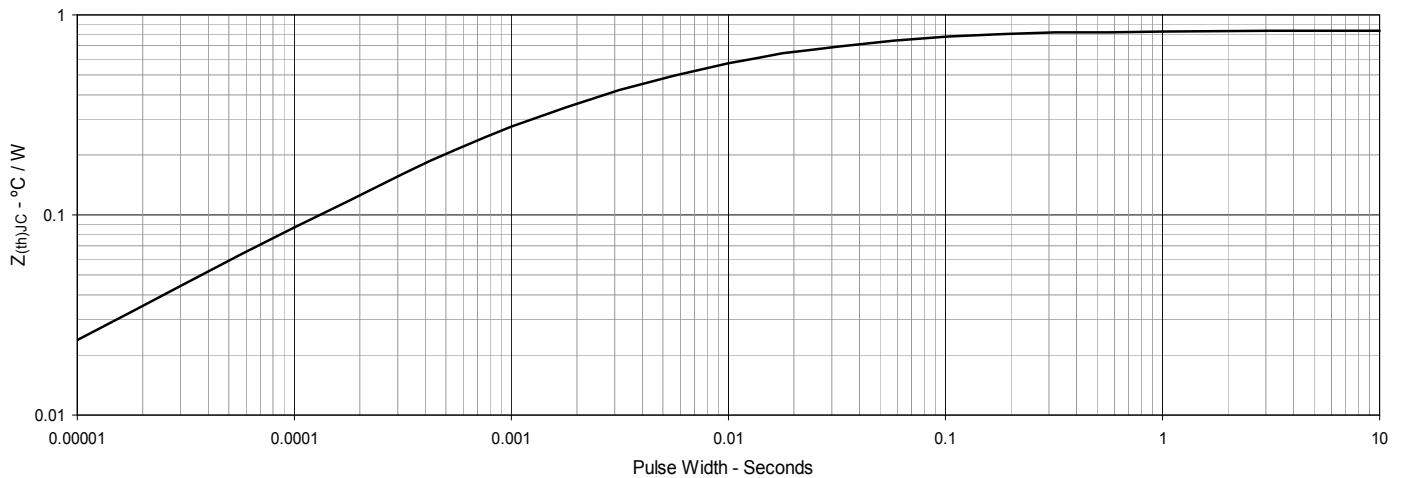

Fig. 12. Inductive Switching Energy Loss vs. Gate Resistance

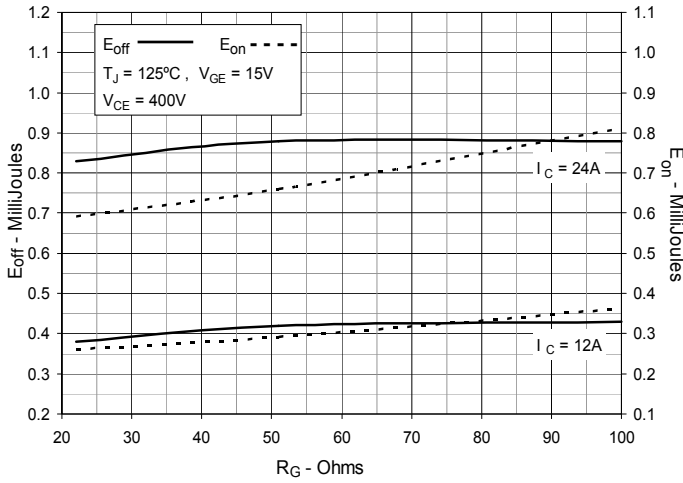

Fig. 13. Inductive Switching Energy Loss vs. Collector Current

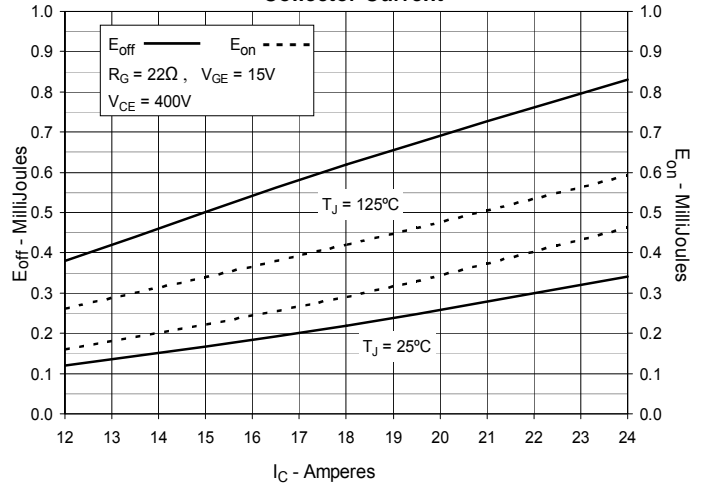

Fig. 14. Inductive Switching Energy Loss vs. Junction Temperature

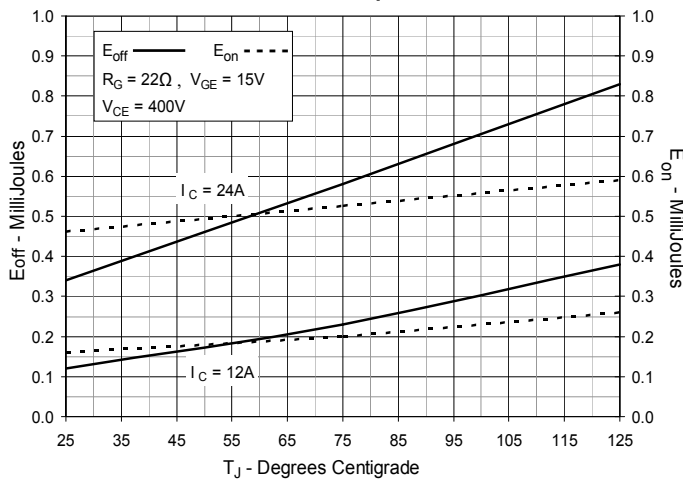

Fig. 15. Inductive Turn-off Switching Times vs. Gate Resistance

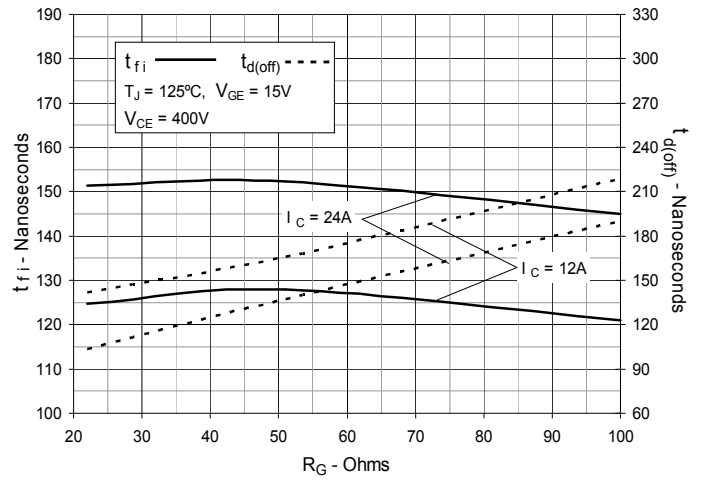

Fig. 16. Inductive Turn-off Switching Times vs. Collector Current

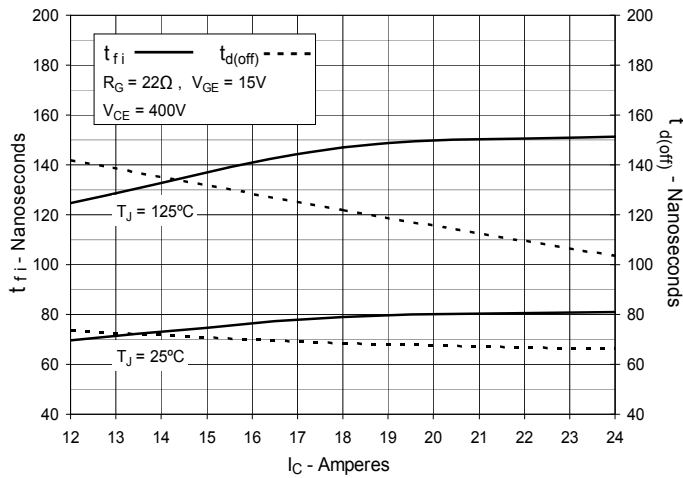

Fig. 17. Inductive Turn-off Switching Times vs. Junction Temperature

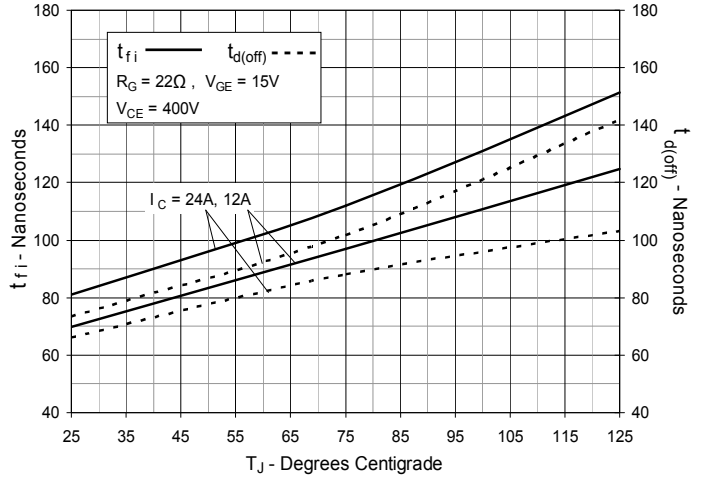

Fig. 18. Inductive Turn-on Switching Times vs. Gate Resistance

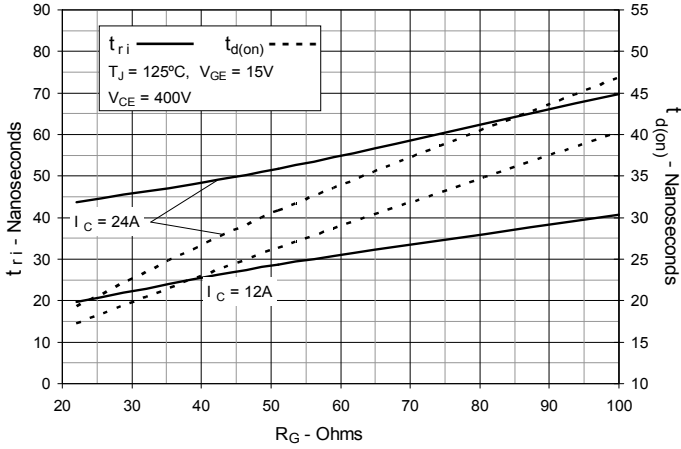

Fig. 19. Inductive Turn-on Switching Times vs. Collector Current

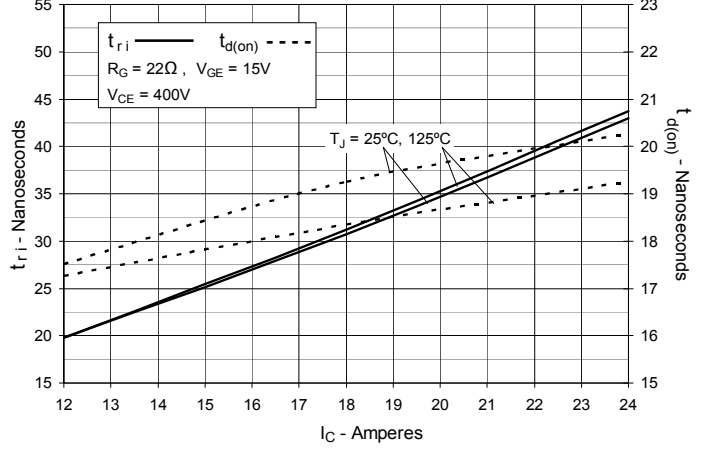
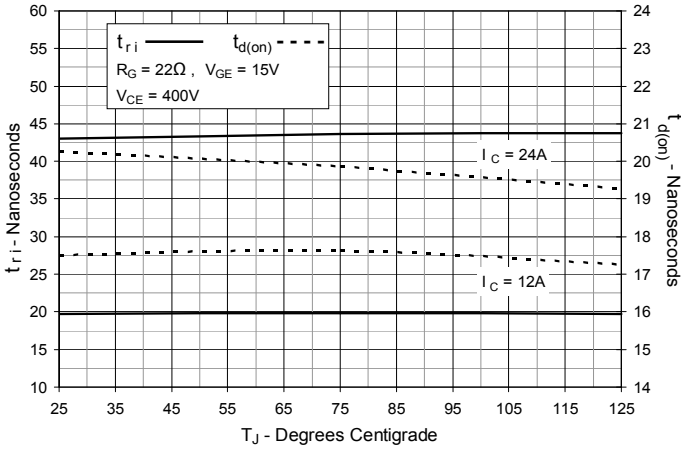

Fig. 20. Inductive Turn-on Switching Times vs. Junction Temperature





Disclaimer Notice - Information furnished is believed to be accurate and reliable. However, users should independently evaluate the suitability of and test each product selected for their own applications. Littelfuse products are not designed for, and may not be used in, all applications. Read complete Disclaimer Notice at www.littelfuse.com/disclaimer-electronics.