

HiPerFAST™ IGBT with Fast Diode

IXGH 50N90B2D1
IXGK 50N90B2D1
IXGX 50N90B2D1

V_{CES} = 900 V
 I_{C25} = 75 A
 $V_{CE(sat)}$ = 2.7 V
 $t_{fi typ}$ = 200 ns

B2-Class High Speed IGBT with Fast Diode

Preliminary Data Sheet



Symbol	Test Conditions	Maximum Ratings	
V_{CES}	$T_J = 25^\circ\text{C}$ to 150°C	900	V
V_{CGR}	$T_J = 25^\circ\text{C}$ to 150°C ; $R_{GE} = 1\text{ M}\Omega$	900	V
V_{GES}	Continuous	± 20	V
V_{GEM}	Transient	± 30	V
I_{C25}	$T_C = 25^\circ\text{C}$ (limited by leads)	75	A
I_{C110}	$T_C = 110^\circ\text{C}$	50	A
I_{CM}	$T_C = 25^\circ\text{C}$, 1 ms	200	A
SSOA (RBSOA)	$V_{GE} = 15\text{ V}$, $T_{VJ} = 125^\circ\text{C}$, $R_G = 10\ \Omega$ Clamped inductive load @ $\leq 600\text{V}$	$I_{CM} = 100$	A
P_C	$T_C = 25^\circ\text{C}$	400	W
T_J		-55 ... +150	$^\circ\text{C}$
T_{JM}		150	$^\circ\text{C}$
T_{stg}		-55 ... +150	$^\circ\text{C}$
Maximum lead temperature for soldering 1.6 mm (0.062 in.) from case for 10 s		300	$^\circ\text{C}$
M_d	Mounting torque (TO-247, TO-264)	1.13/10Nm/lb.in.	
F_C	Mounting force (PLUS247)	20..120 / 4.5..25	N/lb
Weight		TO-247	6 g
		TO-264	10 g
		PLUS247	6 g

TO-247 (IXGH)

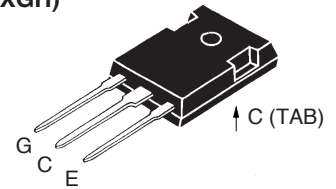

PLUS247 (IXGX)

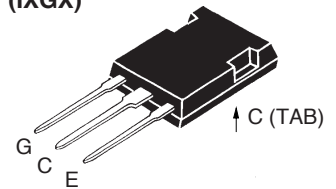

TO-264 (IXGK)

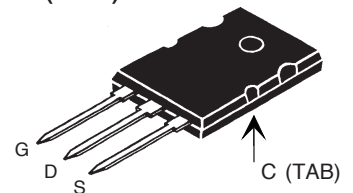

G = Gate C = Collector
E = Emitter TAB = Collector

Features

- High frequency IGBT
- High current handling capability
- MOS Gate turn-on
- drive simplicity

Applications

- PFC circuits
- Uninterruptible power supplies (UPS)
- Switched-mode and resonant-mode power supplies
- AC motor speed control
- DC servo and robot drives
- DC choppers

Advantages

- High power density
- Very fast switching speeds for high frequency applications

Symbol	Test Conditions ($T_J = 25^\circ\text{C}$ unless otherwise specified)	Characteristic Values		
		min.	typ.	max.
$V_{GE(th)}$	$I_C = 250\ \mu\text{A}$, $V_{CE} = V_{GE}$	3.0		5.0 V
I_{CES}	$V_{CE} = V_{CES}$ $V_{GE} = 0\text{ V}$ $T_J = 150^\circ\text{C}$			50 μA
				1 mA
I_{GES}	$V_{CE} = 0\text{ V}$, $V_{GE} = \pm 20\text{ V}$			$\pm 100\text{ nA}$
$V_{CE(sat)}$	$I_C = I_{C110}$, $V_{GE} = 15\text{ V}$, Note 1 $T_J = 125^\circ\text{C}$	2.2	2.7	V V

Symbol	Test Conditions ($T_J = 25^\circ\text{C}$ unless otherwise specified)	Characteristic Values			
		min.	typ.	max.	
g_{fs}	$I_C = I_{C110}; V_{CE} = 10\text{ V}$, Note 1	25	40	S	
C_{ies}	$V_{CE} = 25\text{ V}$, $V_{GE} = 0\text{ V}$, $f = 1\text{ MHz}$		2500	pF	
C_{oes}			205	pF	
C_{res}			75	pF	
Q_g	$I_C = I_{C110}$, $V_{GE} = 15\text{ V}$, $V_{CE} = 0.5 V_{CES}$		135	nC	
Q_{ge}			23	nC	
Q_{gc}			50	nC	
$t_{d(on)}$	Inductive load $I_C = I_{C110}$, $V_{GE} = 15\text{ V}$ $V_{CE} = 720\text{ V}$, $R_G = R_{off} = 5\ \Omega$		20	ns	
t_{ri}			28	ns	
$t_{d(off)}$			350	500	ns
t_{fi}			200		ns
E_{off}			4.7	7.5	mJ
$t_{d(on)}$		Inductive load, $T_J = 125^\circ\text{C}$ $I_C = I_{C110}$, $V_{GE} = 15\text{ V}$ $V_{CE} = 720\text{ V}$, $R_G = R_{off} = 5\ \Omega$		20	ns
t_{ri}			28	ns	
E_{on}			1.5		mJ
$t_{d(off)}$			400		ns
t_{fi}			420		ns
E_{off}			8.7		mJ
R_{thJC}				0.31 K/W	
R_{thCH}		0.21		K/W	

Diode

Symbol	Conditions	Maximum Ratings	
I_{F25}	$T_C = 115^\circ\text{C}$	30	A

Symbol	Conditions ($T_J = 25^\circ\text{C}$ unless otherwise specified)	Characteristic Values		
		min.	typ.	max.
V_F	$I_F = 30\text{ A}$; Note 1 $T_{VJ} = 150^\circ\text{C}$		2.5	2.75 V
			1.8	V
I_{RM}	$I_F = 10\text{ A}$; $di_F/dt = -100\text{ A}/\mu\text{s}$; $T_{VJ} = 100^\circ\text{C}$ $V_R = 100\text{ V}$; $V_{GE} = 0\text{ V}$		5.5	11.5 A
t_{rr}			200	
R_{thJC}	with heat transfer paste			0.9 K/W
R_{thCH}			0.25	

Note 1: Pulse test, $t \leq 300\ \mu\text{s}$, duty cycle $\leq 2\%$

IXYS reserves the right to change limits, test conditions, and dimensions.

IXYS MOSFETs and IGBTs are covered by one or more of the following U.S. patents:	4,835,592	4,931,844	5,049,961	5,237,481	6,162,665	6,404,065 B1	6,683,344	6,727,585
	4,850,072	5,017,508	5,063,307	5,381,025	6,259,123 B1	6,534,343	6,710,405 B2	6,759,692
	4,881,106	5,034,796	5,187,117	5,486,715	6,306,728 B1	6,583,505	6,710,463	6,771,478 B2

Fig. 1. Output Characteristics
@ 25 °C

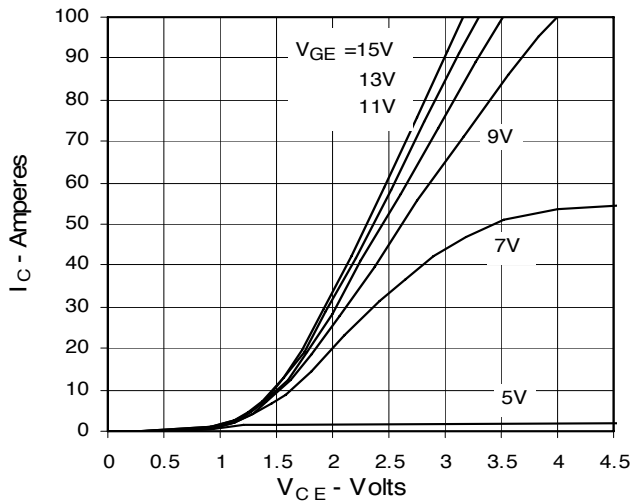

Fig. 2. Extended Output Characteristics
@ 25 °C

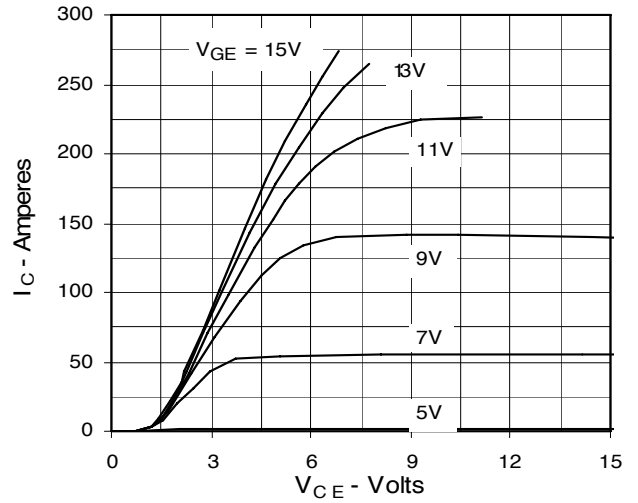

Fig. 3. Output Characteristics
@ 125 °C

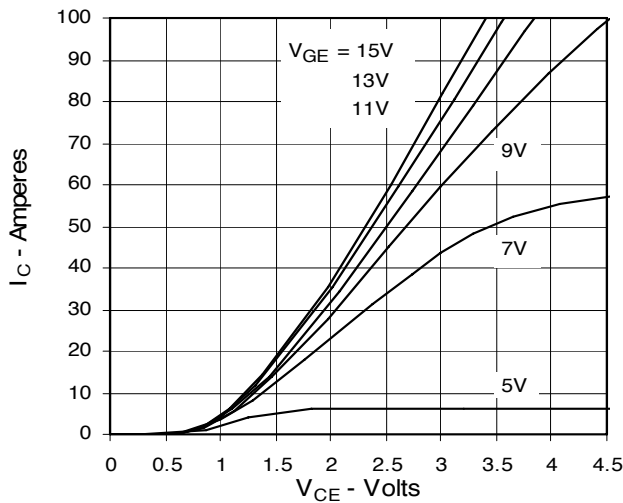

Fig. 4. Dependence of $V_{CE(sat)}$ on Temperature

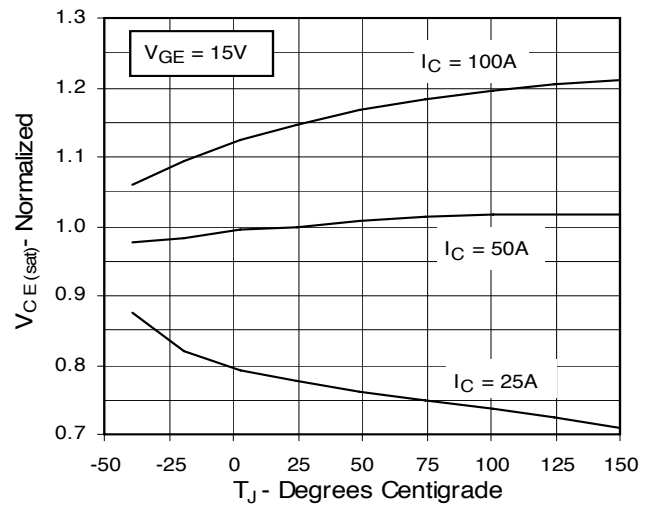

Fig. 5. Collector-to-Emitter Voltage vs. Gate-to-Emitter voltage

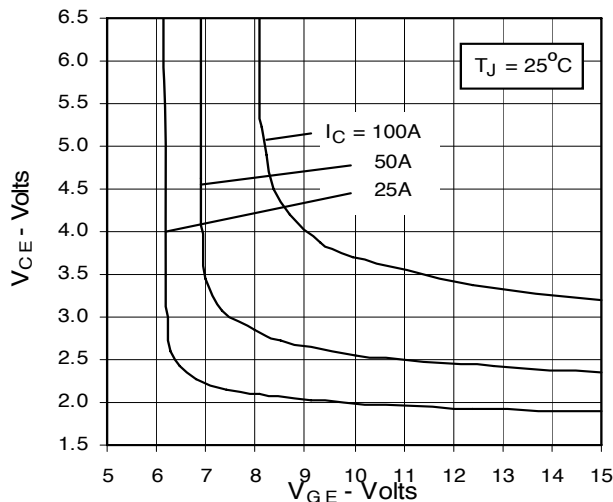

Fig. 6. Input Admittance

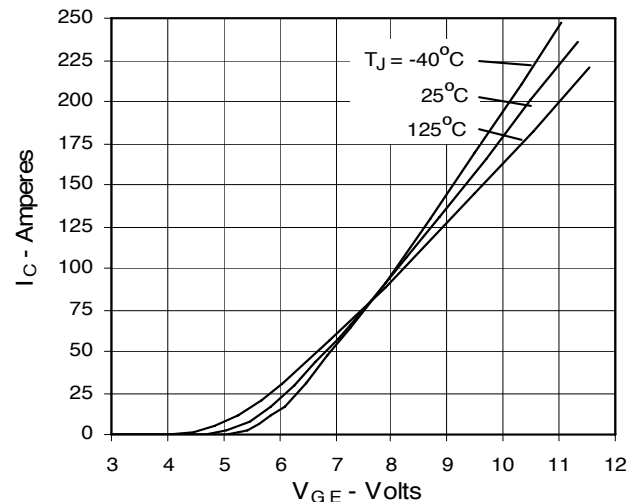

Fig. 7. Transconductance

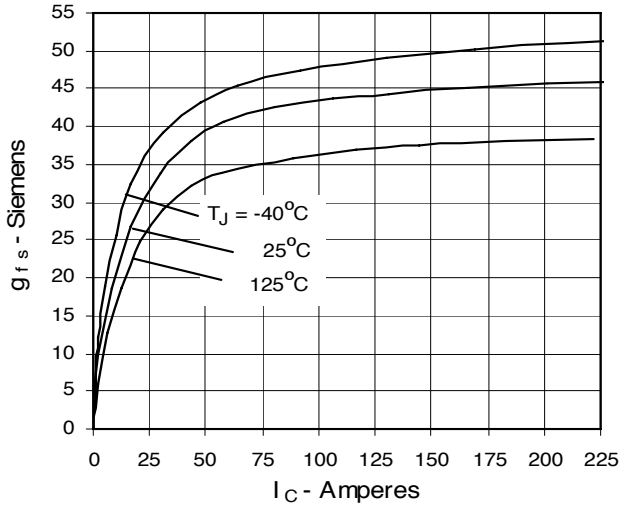

Fig. 8. Dependence of Turn-off Energy Loss on R_G

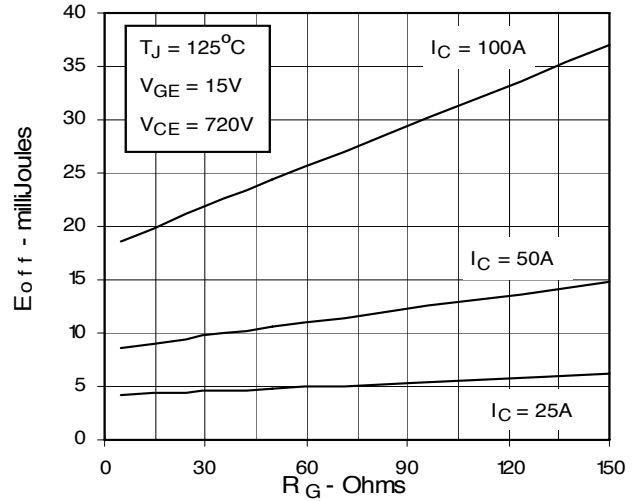

Fig. 9. Dependence of Turn-Off Energy Loss on I_C

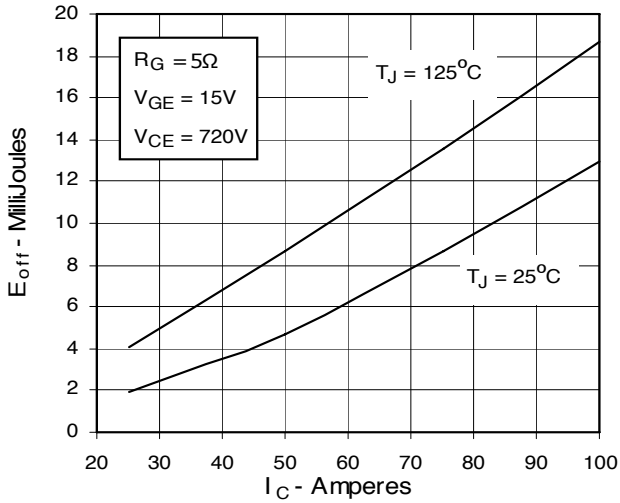

Fig. 10. Dependence of Turn-off Energy Loss on Temperature

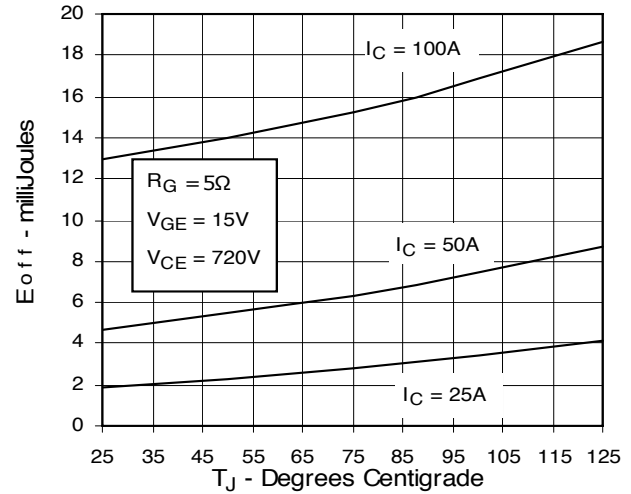

Fig. 11. Dependence of Turn-off Switching Time on R_G

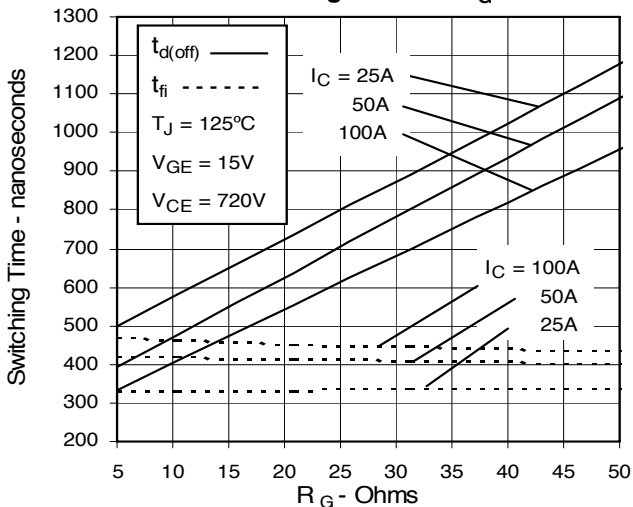

Fig. 12. Dependence of Turn-off Switching Time on I_C

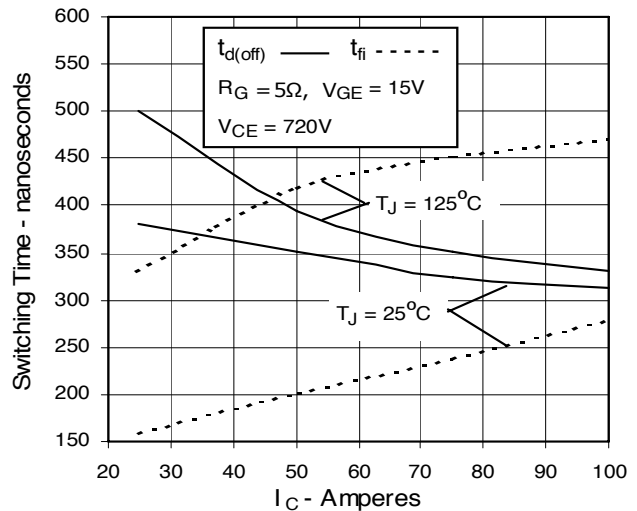

Fig. 13. Dependence of Turn-off Switching Time on Temperature

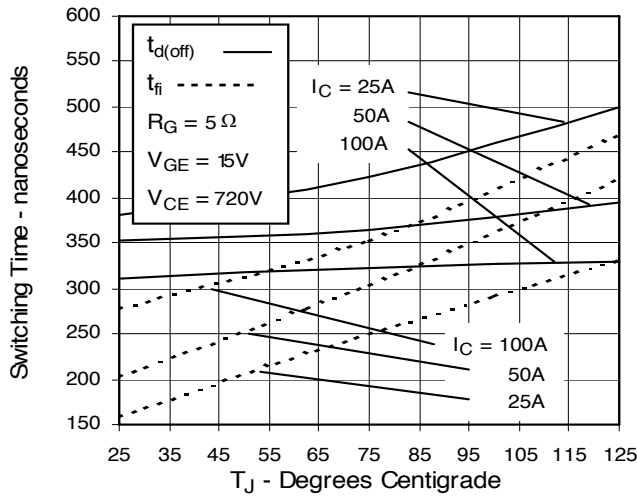

Fig. 14. Gate Charge

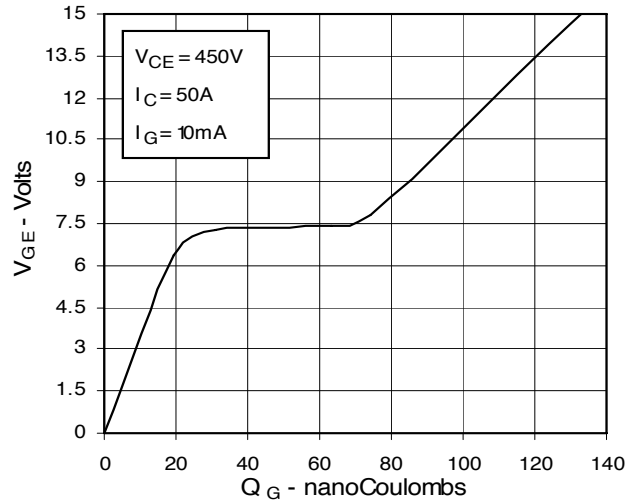

Fig. 15. Capacitance

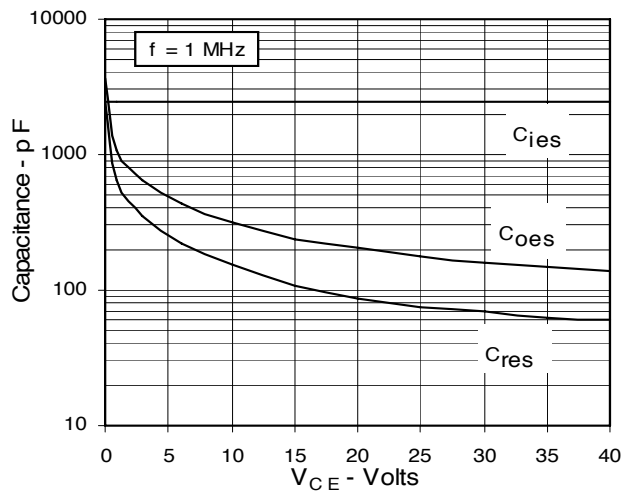

Fig. 16. Reverse-Bias Safe Operating Area

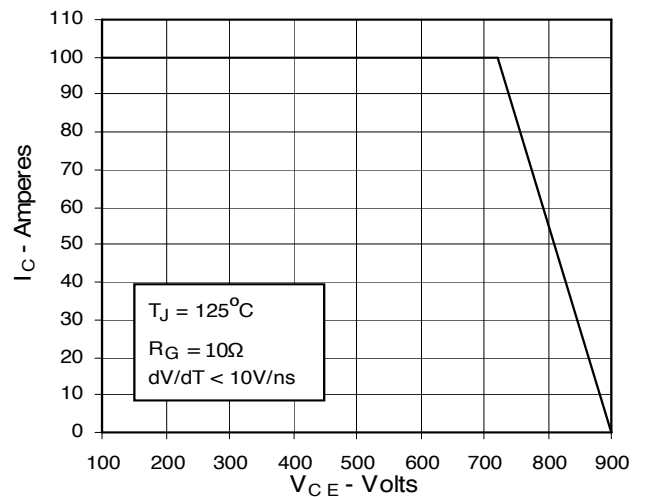
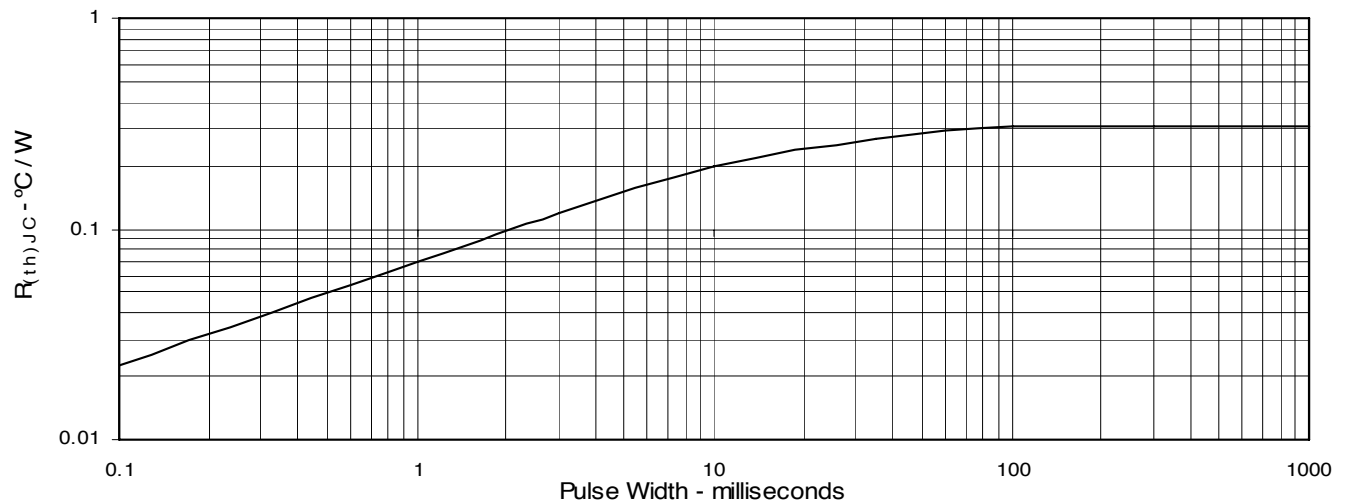

Fig. 17. Maximum Transient Thermal Resistance



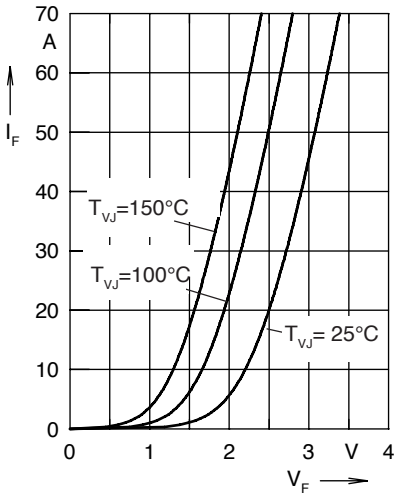

Fig. 18. Forward current I_F versus V_F

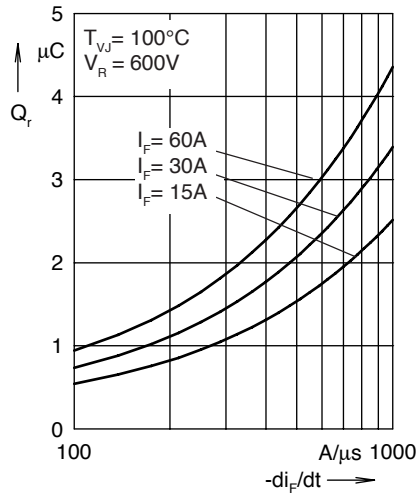

Fig. 19. Reverse recovery charge Q_r versus $-di_F/dt$

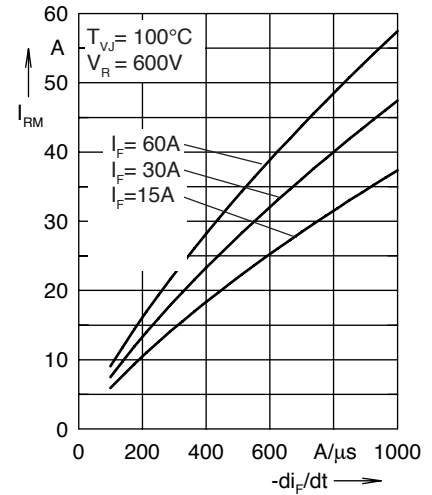

Fig. 20. Peak reverse current I_{RM} versus $-di_F/dt$

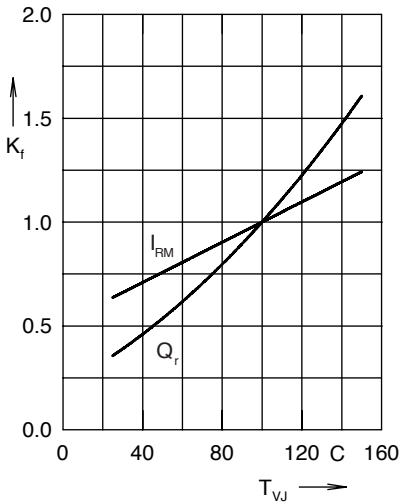

Fig. 21. Dynamic parameters Q_r , I_{RM} versus T_{VJ}

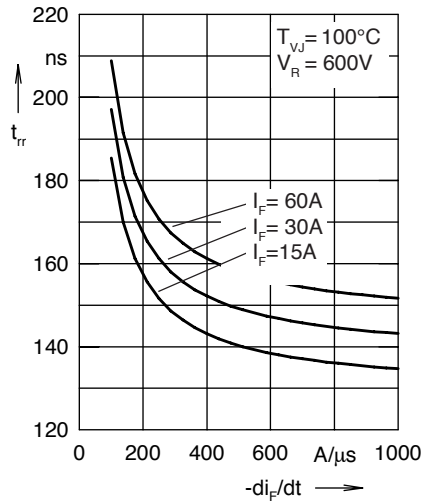

Fig. 22. Recovery time t_{rr} versus $-di_F/dt$

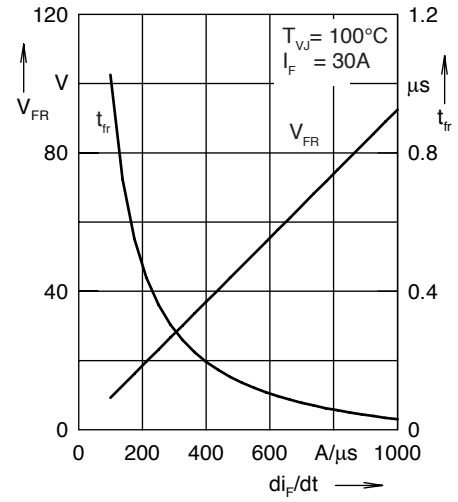

Fig. 23. Peak forward voltage V_{FR} and t_{fr} versus di_F/dt

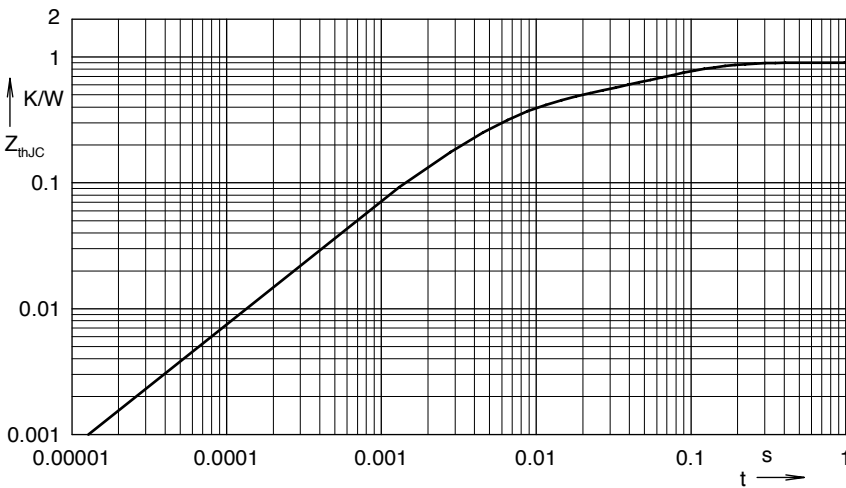

Fig. 24. Transient thermal resistance junction to case

Constants for Z_{thJC} calculation:

i	R_{thi} (K/W)	t_i (s)
1	0.465	0.0052
2	0.179	0.0003
3	0.256	0.0397

Package Outlines

TO-247 AD Outline

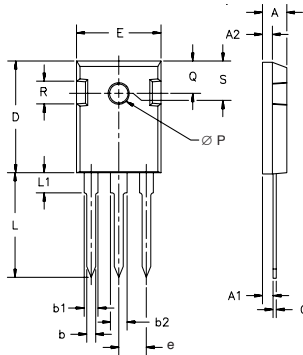

Dim.	Millimeter		Inches	
	Min.	Max.	Min.	Max.
A	4.7	5.3	.185	.209
A ₁	2.2	2.54	.087	.102
A ₂	2.2	2.6	.059	.098
b	1.0	1.4	.040	.055
b ₁	1.65	2.13	.065	.084
b ₂	2.87	3.12	.113	.123
C	.4	.8	.016	.031
D	20.80	21.46	.819	.845
E	15.75	16.26	.610	.640
e	5.20	5.72	0.205	0.225
L	19.81	20.32	.780	.800
L1		4.50		.177
ØP	3.55	3.65	.140	.144
Q	5.89	6.40	0.232	0.252
R	4.32	5.49	.170	.216
S	6.15	BSC	.242	BSC

PLUS 247™ Outline

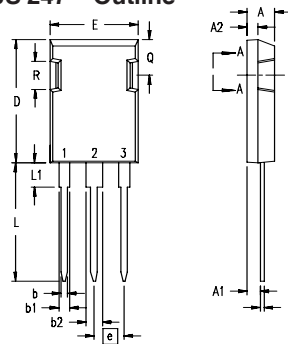

Dim.	Millimeter		Inches	
	Min.	Max.	Min.	Max.
A	4.83	5.21	.190	.205
A ₁	2.29	2.54	.090	.100
A ₂	1.91	2.16	.075	.085
b	1.14	1.40	.045	.055
b ₁	1.91	2.13	.075	.084
b ₂	2.92	3.12	.115	.123
C	0.61	0.80	.024	.031
D	20.80	21.34	.819	.840
E	15.75	16.13	.620	.635
e	5.45	BSC	.215	BSC
L	19.81	20.32	.780	.800
L1	3.81	4.32	.150	.170
Q	5.59	6.20	.220	0.244
R	4.32	4.83	.170	.190

TO-264 AA Outline

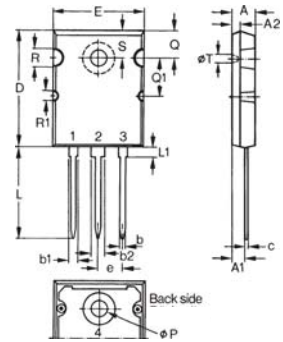

Dim.	Millimeter		Inches	
	Min.	Max.	Min.	Max.
A	4.82	5.13	.190	.202
A ₁	2.54	2.89	.100	.114
A ₂	2.00	2.10	.079	.083
b	1.12	1.42	.044	.056
b ₁	2.39	2.69	.094	.106
b ₂	2.90	3.09	.114	.122
c	0.53	0.83	.021	.033
D	25.91	26.16	1.020	1.030
E	19.81	19.96	.780	.786
e	5.46	BSC	.215	BSC
J	0.00	0.25	.000	.010
K	0.00	0.25	.000	.010
L	20.32	20.83	.800	.820
L1	2.29	2.59	.090	.102
P	3.17	3.66	.125	.144
Q	6.07	6.27	.239	.247
Q1	8.38	8.69	.330	.342
R	3.81	4.32	.150	.170
R1	1.78	2.29	.070	.090
S	6.04	6.30	.238	.248
T	1.57	1.83	.062	.072

Terminals: 1 - Gate
 2 - Drain (Collector)
 3 - Source (Emitter)
 4 - Drain (Collector)

PRELIMINARY TECHNICAL INFORMATION

The product presented herein is under development. The Technical Specifications offered are derived from data gathered during objective characterizations of preliminary engineering lots; but also may yet contain some information supplied during a subjective pre-production design evaluation. IXYS reserves the right to change limits, test conditions, and dimensions without notice.



Disclaimer Notice - Information furnished is believed to be accurate and reliable. However, users should independently evaluate the suitability of and test each product selected for their own applications. Littelfuse products are not designed for, and may not be used in, all applications. Read complete Disclaimer Notice at www.littelfuse.com/disclaimer-electronics.