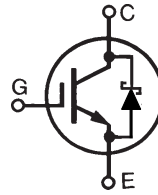
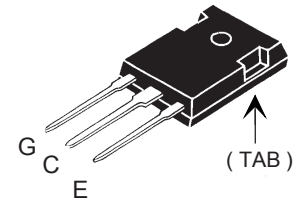

**GenX3™ 600V IGBT
w/ SiC Anti-Parallel
Diode**
IXGH48N60B3C1

| | | |
|---------------|---|--------------|
| V_{CES} | = | 600V |
| I_{C110} | = | 48A |
| $V_{CE(sat)}$ | ≤ | 1.8V |
| $t_{fi(typ)}$ | = | 116ns |

 Medium Speed Low Vsat PT
IGBT 5 - 40 kHz Switching

TO-247

G = Gate C = Collector
E = Emitter TAB = Collector

| Symbol | Test Conditions | Maximum Ratings | |
|-------------------------------|--|------------------------------------|------------------|
| V_{CES} | $T_C = 25^\circ\text{C}$ to 150°C | 600 | V |
| V_{CGR} | $T_J = 25^\circ\text{C}$ to 150°C , $R_{GE} = 1\text{M}\Omega$ | 600 | V |
| V_{GES} | Continuous | ± 20 | V |
| V_{GEM} | Transient | ± 30 | V |
| I_{C25} | $T_C = 25^\circ\text{C}$ (Limited by Leads) | 75 | A |
| I_{C110} | $T_C = 110^\circ\text{C}$ | 48 | A |
| I_{F110} | $T_C = 110^\circ\text{C}$ | 20 | A |
| I_{CM} | $T_C = 25^\circ\text{C}$, 1ms | 280 | A |
| SSOA (RBSOA) | $V_{GE} = 15\text{V}$, $T_{VJ} = 125^\circ\text{C}$, $R_G = 5\Omega$ Clamped Inductive Load | $I_{CM} = 120$ @ $\leq V_{CES}$ | A |
| P_C | $T_C = 25^\circ\text{C}$ | 300 | W |
| T_J | | -55 ... +150 | $^\circ\text{C}$ |
| T_{JM} | | 150 | $^\circ\text{C}$ |
| T_{stg} | | -55 ... +150 | $^\circ\text{C}$ |
| T_L | 1.6mm (0.062 in.) from Case for 10s | 300 | $^\circ\text{C}$ |
| T_{SOLD} | Plastic Body for 10 seconds | 260 | $^\circ\text{C}$ |
| M_d | Mounting Torque | 1.13/10 | Nm/lb.in. |
| Weight | | 6 | g |

Features

- Optimized for Low Conduction and Switching Losses
- Square RBSOA
- Anti-Parallel Schottky Diode
- International Standard Package

Advantages

- High Power Density
- Low Gate Drive Requirement

Applications

- Power Inverters
- UPS
- Motor Drives
- SMPS
- PFC Circuits
- Battery Chargers
- Welding Machines
- Lamp Ballasts

| Symbol | Test Conditions ($T_J = 25^\circ\text{C}$ Unless Otherwise Specified) | Characteristic Values | | |
|---------------|---|-----------------------|------|-----------------------------|
| | | Min. | Typ. | Max. |
| BV_{CES} | $I_C = 250\mu\text{A}$, $V_{GE} = 0\text{V}$ | 600 | | V |
| $V_{GE(th)}$ | $I_C = 250\mu\text{A}$, $V_{CE} = V_{GE}$ | 3.0 | | 5.0 V |
| I_{CES} | $V_{CE} = V_{CES}$, $V_{GE} = 0\text{V}$ $T_J = 125^\circ\text{C}$ | | | 50 μA 1.75 mA |
| I_{GES} | $V_{CE} = 0\text{V}$, $V_{GE} = \pm 20\text{V}$ | | | ±100 nA |
| $V_{CE(sat)}$ | $I_C = 32\text{A}$, $V_{GE} = 15\text{V}$, Note 1 | | | 1.8 V |

| Symbol Test Conditions ($T_J = 25^\circ\text{C}$ Unless Otherwise Specified) | | Characteristic Values | | |
|--|---|-----------------------|------|--------------------|
| | | Min. | Typ. | Max. |
| g_{fs} | $I_C = 30\text{A}, V_{CE} = 10\text{V}, \text{Note 1}$ | 28 | 46 | S |
| C_{ies} | $V_{CE} = 25\text{V}, V_{GE} = 0\text{V}, f = 1\text{MHz}$ | | 3980 | pF |
| C_{oes} | | | 190 | pF |
| C_{res} | | | 45 | pF |
| Q_g | $I_C = 40\text{A}, V_{GE} = 15\text{V}, V_{CE} = 0.5 \cdot V_{CES}$ | | 115 | nC |
| Q_{ge} | | | 21 | nC |
| Q_{gc} | | | 40 | nC |
| $t_{d(on)}$ | Inductive Load, $T_J = 25^\circ\text{C}$ $I_C = 30\text{A}, V_{GE} = 15\text{V}$ $V_{CE} = 480\text{V}, R_G = 5\Omega$ Note 2 | | 22 | ns |
| t_{ri} | | | 26 | ns |
| E_{on} | | | 0.45 | mJ |
| $t_{d(off)}$ | | | 130 | 200 ns |
| t_{fi} | | | 116 | 200 ns |
| E_{off} | | | 0.66 | 1.20 mJ |
| $t_{d(on)}$ | Inductive Load, $T_J = 125^\circ\text{C}$ $I_C = 30\text{A}, V_{GE} = 15\text{V}$ $V_{CE} = 480\text{V}, R_G = 5\Omega$ Note 2 | | 22 | ns |
| t_{ri} | | | 26 | ns |
| E_{on} | | | 0.50 | mJ |
| $t_{d(off)}$ | | | 190 | ns |
| t_{fi} | | | 157 | ns |
| E_{off} | | | 1.30 | mJ |
| R_{thJC} | | | 0.42 | $^\circ\text{C/W}$ |
| R_{thCS} | | 0.21 | | $^\circ\text{C/W}$ |

TO-247 (IXGH) Outline

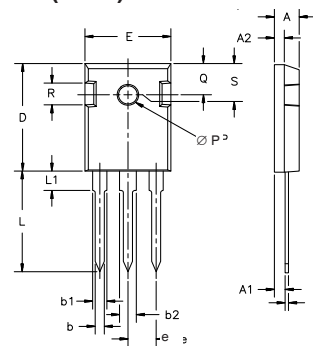

| Dim. | Millimeter | | Inches | |
|----------------|------------|-------|--------|-------|
| | Min. | Max. | Min. | Max. |
| A | 4.7 | 5.3 | .185 | .209 |
| A ₁ | 2.2 | 2.54 | .087 | .102 |
| A ₂ | 2.2 | 2.6 | .059 | .098 |
| b | 1.0 | 1.4 | .040 | .055 |
| b ₁ | 1.65 | 2.13 | .065 | .084 |
| b ₂ | 2.87 | 3.12 | .113 | .123 |
| C | .4 | .8 | .016 | .031 |
| D | 20.80 | 21.46 | .819 | .845 |
| E | 15.75 | 16.26 | .610 | .640 |
| e | 5.20 | 5.72 | 0.205 | 0.225 |
| L | 19.81 | 20.32 | .780 | .800 |
| L1 | | 4.50 | | .177 |
| ∅P | 3.55 | 3.65 | .140 | .144 |
| Q | 5.89 | 6.40 | 0.232 | 0.252 |
| R | 4.32 | 5.49 | .170 | .216 |
| S | 6.15 | BSC | 242 | BSC |

Reverse Diode (SiC)

| Symbol Test Conditions ($T_J = 25^\circ\text{C}$ Unless Otherwise Specified) | | Characteristic Values | | |
|--|---|-----------------------|------|-------------------------|
| | | Min. | Typ. | Max. |
| V_F | $I_F = 20\text{A}, V_{GE} = 0\text{V}, \text{Note 1}$ | | 1.65 | 2.10 V |
| | $T_J = 125^\circ\text{C}$ | | 1.80 | V |
| R_{thJC} | | | | 0.90 $^\circ\text{C/W}$ |

Notes

1. Pulse test, $t \leq 300\mu\text{s}$, duty cycle, $d \leq 2\%$.
2. Switching times & energy losses may increase for higher V_{CE} (Clamp), T_J or R_G .

PRELIMINARY TECHNICAL INFORMATION

The product presented herein is under development. The Technical Specifications offered are derived from data gathered during objective characterizations of preliminary engineering lots; but also may yet contain some information supplied during a pre-production design evaluation. IXYS reserves the right to change limits, test conditions, and dimensions without notice.

IXYS Reserves the Right to Change Limits, Test Conditions and Dimensions.

| | | | | | | | | | | |
|--|-----------|-----------|-----------|-----------|--------------|--------------|--------------|--------------|--------------|-------------|
| IXYS MOSFETs and IGBTs are covered by one or more of the following U.S. patents: | 4,835,592 | 4,931,844 | 5,049,961 | 5,237,481 | 6,162,665 | 6,404,065 B1 | 6,683,344 | 6,727,585 | 7,005,734 B2 | 7,157,338B2 |
| | 4,850,072 | 5,017,508 | 5,063,307 | 5,381,025 | 6,259,123 B1 | 6,534,343 | 6,710,405 B2 | 6,759,692 | 7,063,975 B2 | |
| | 4,881,106 | 5,034,796 | 5,187,117 | 5,486,715 | 6,306,728 B1 | 6,583,505 | 6,710,463 | 6,771,478 B2 | 7,071,537 | |

Fig. 1. Output Characteristics @ 25°C

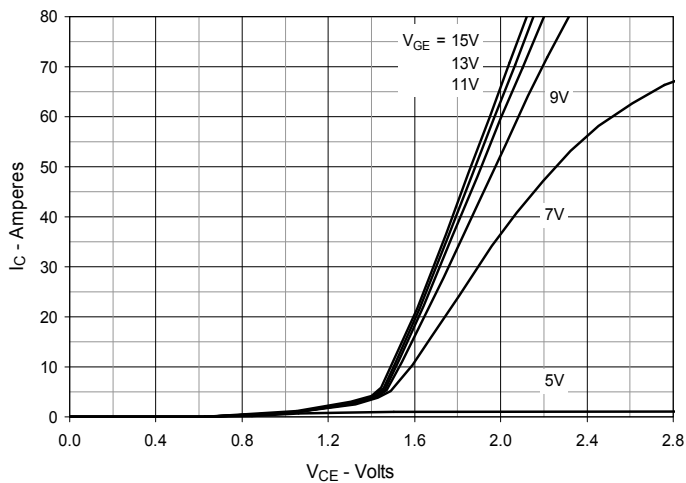

Fig. 2. Extended Output Characteristics @ 25°C

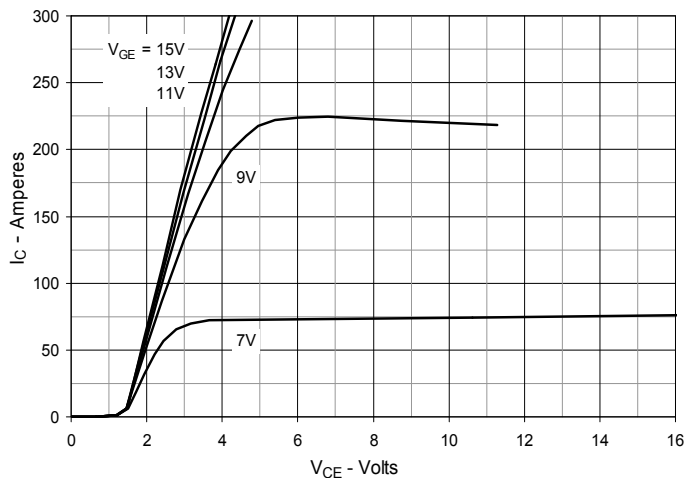

Fig. 3. Output Characteristics @ 125°C

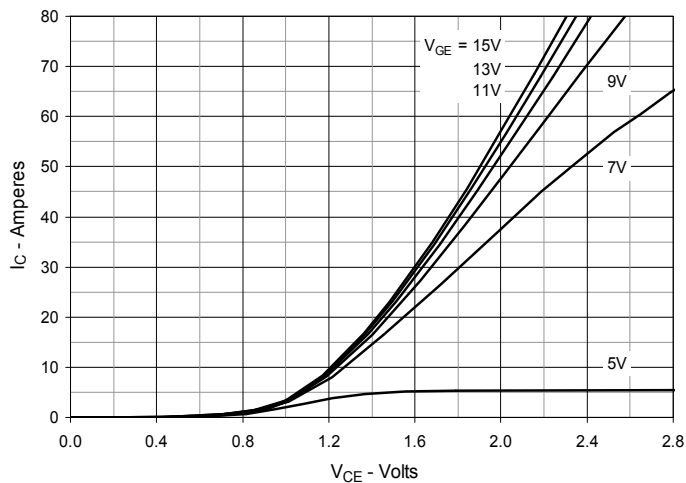

Fig. 4. Dependence of $V_{CE(sat)}$ on Junction Temperature

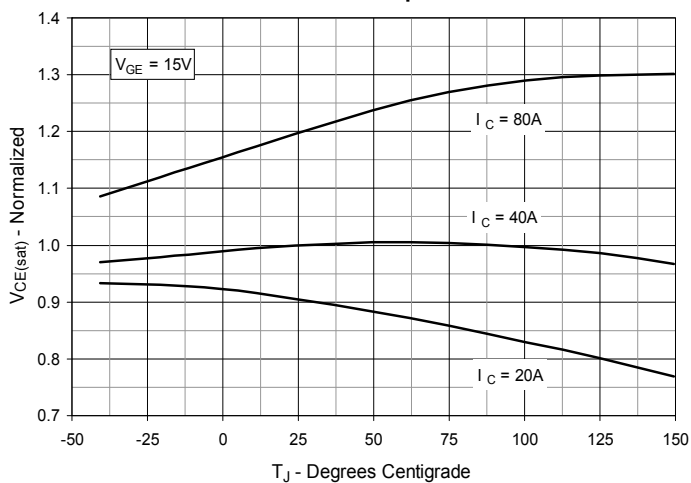

Fig. 5. Collector-to-Emitter Voltage vs. Gate-to-Emitter Voltage

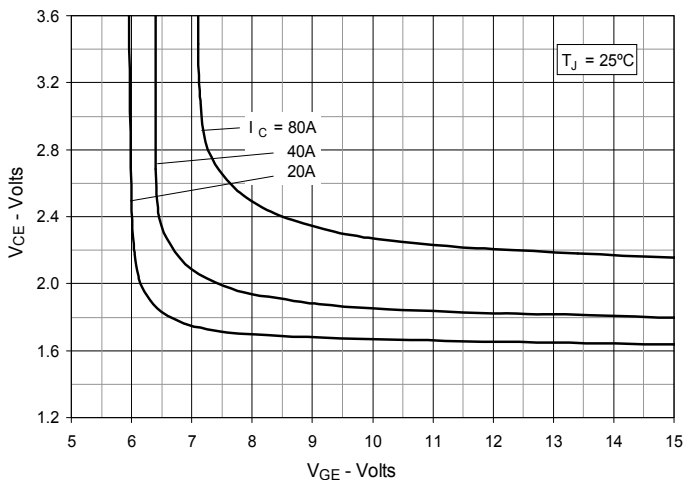

Fig. 6. Input Admittance

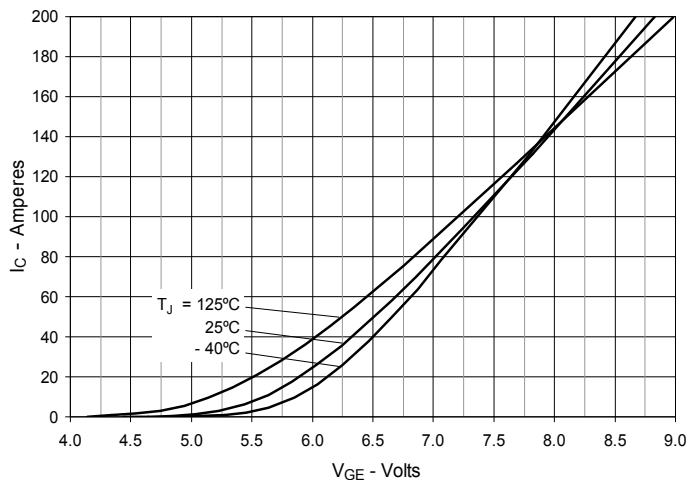
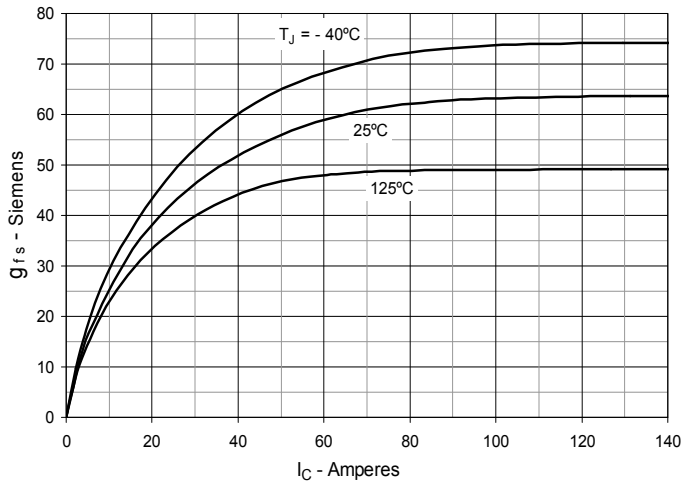
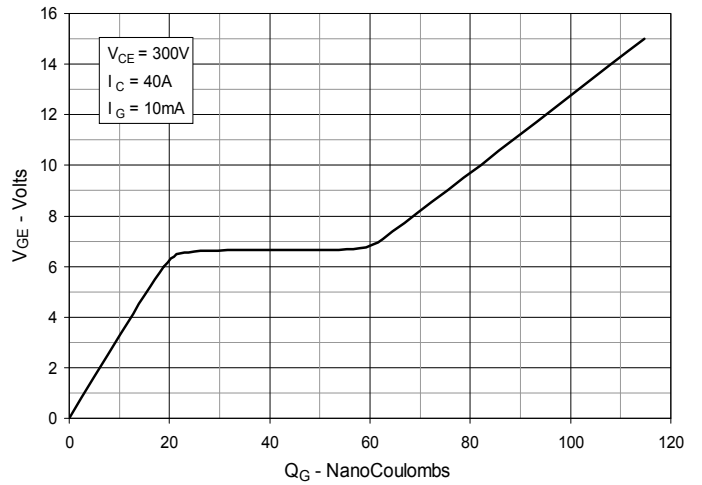
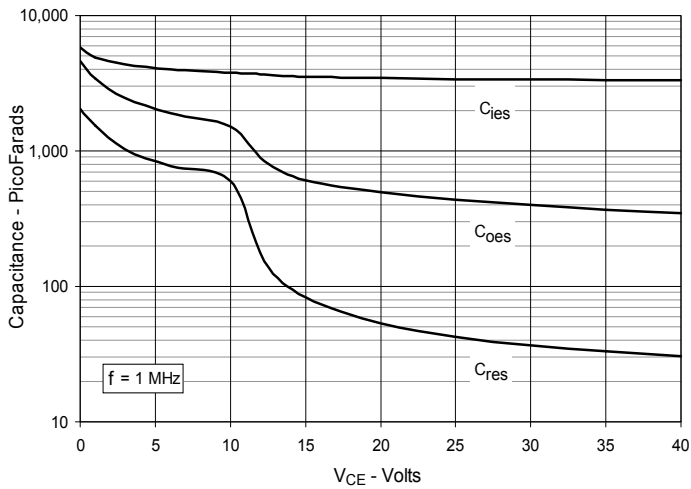
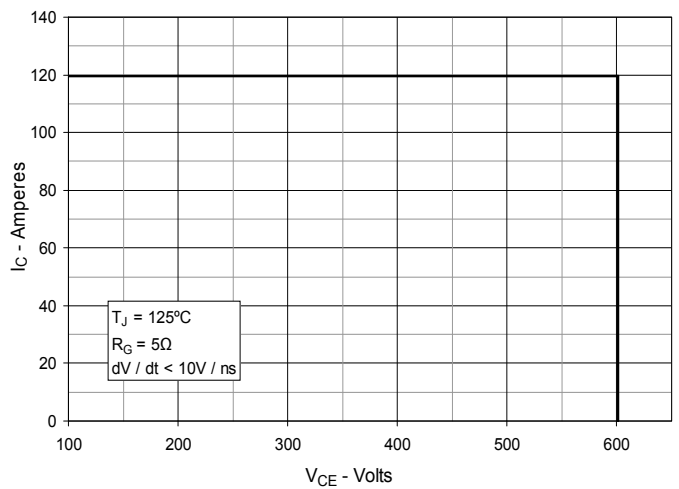
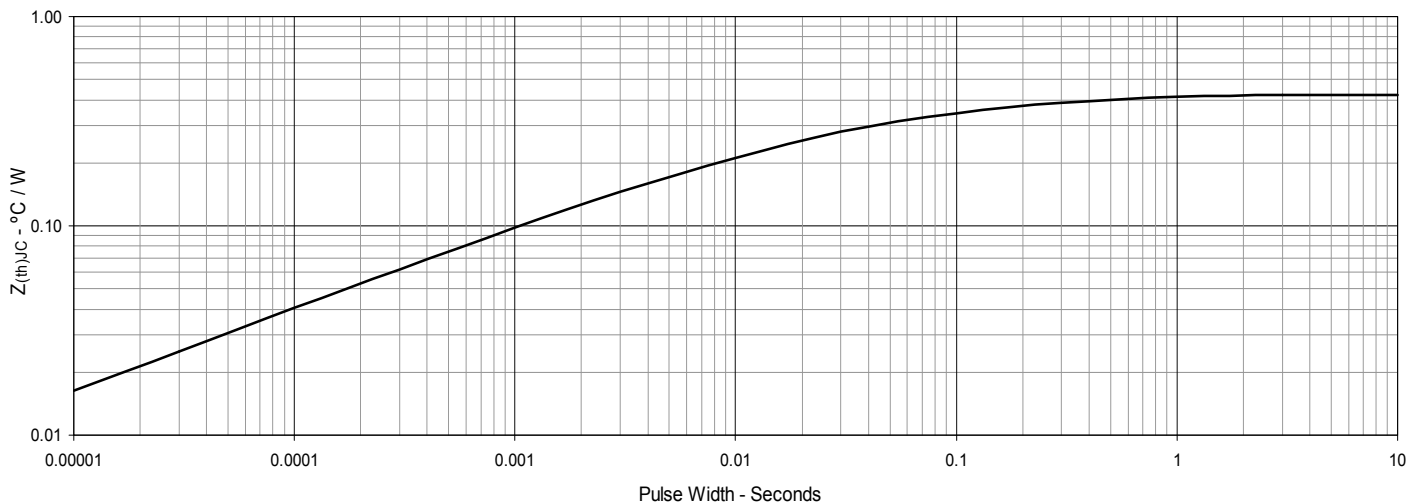
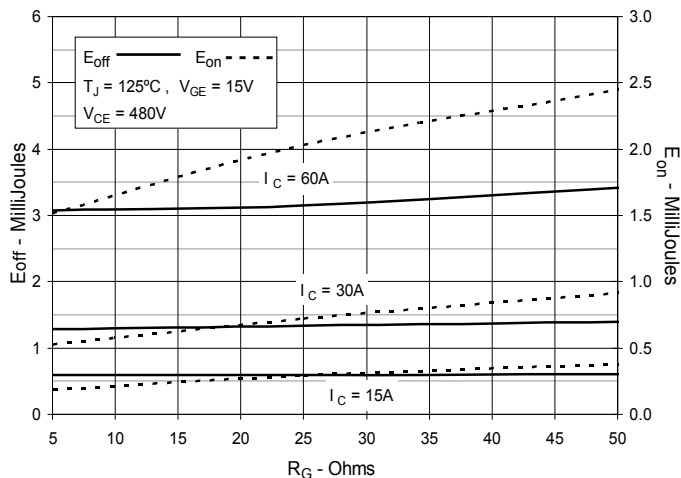
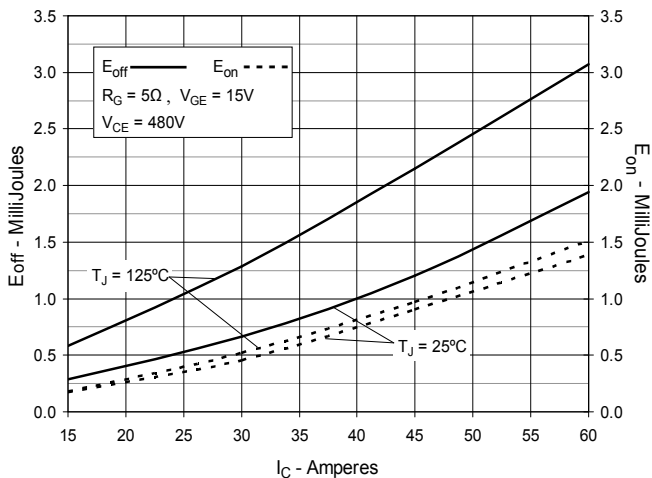
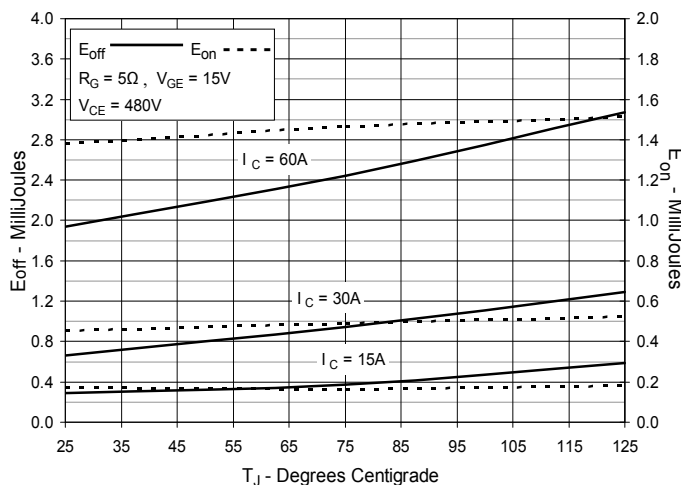
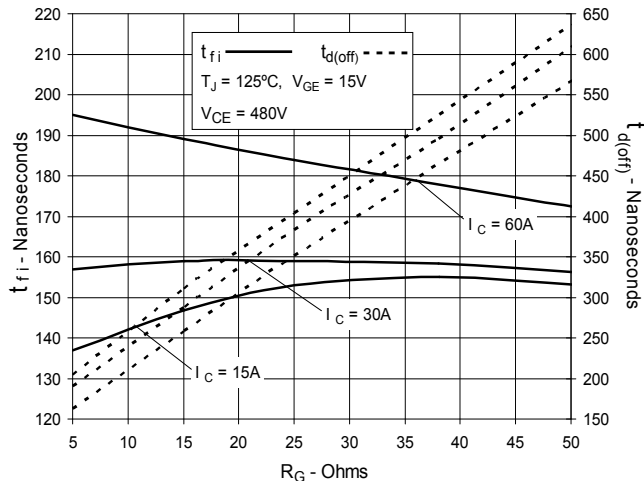
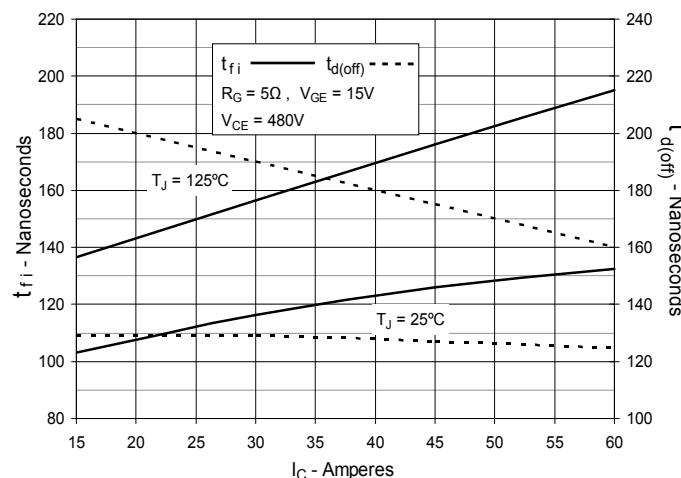
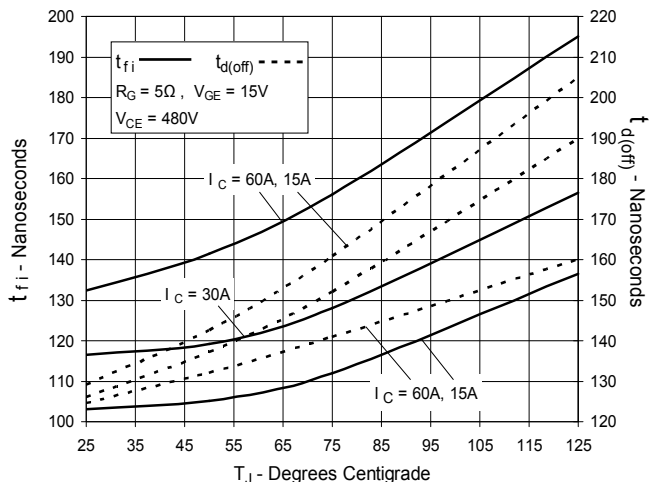
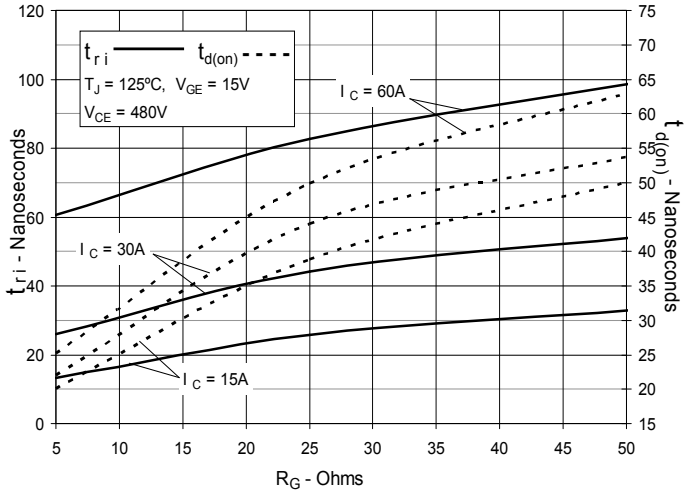
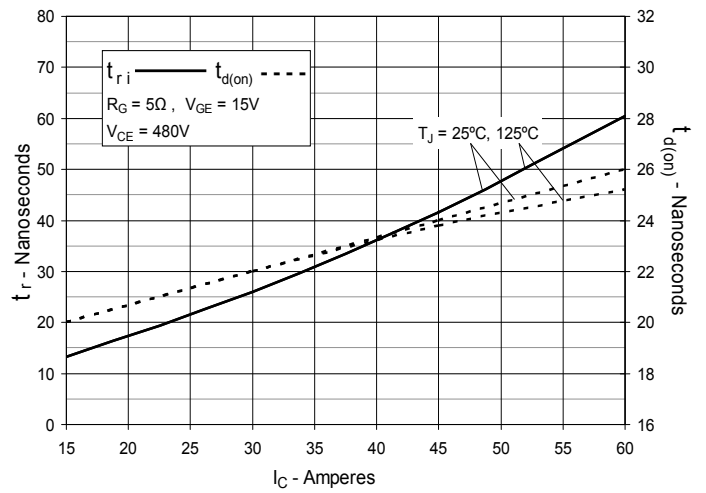
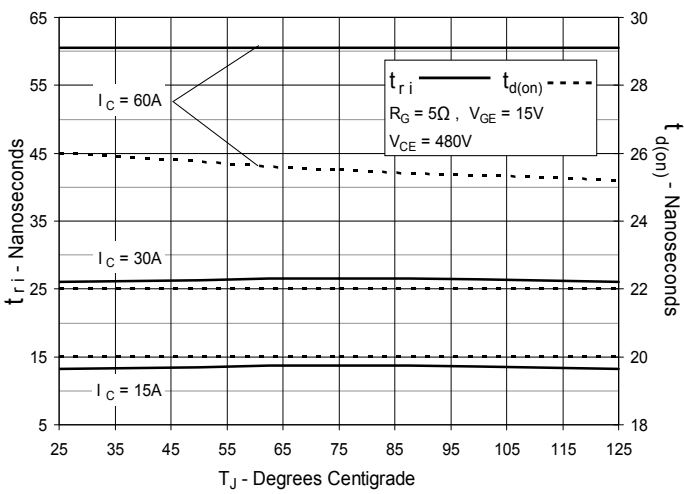
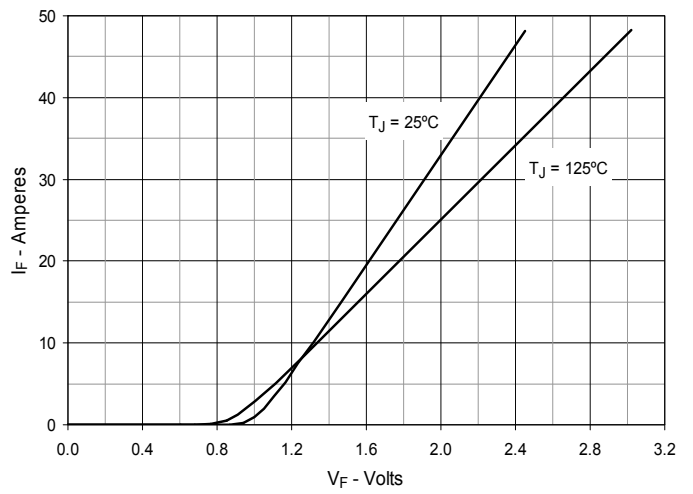
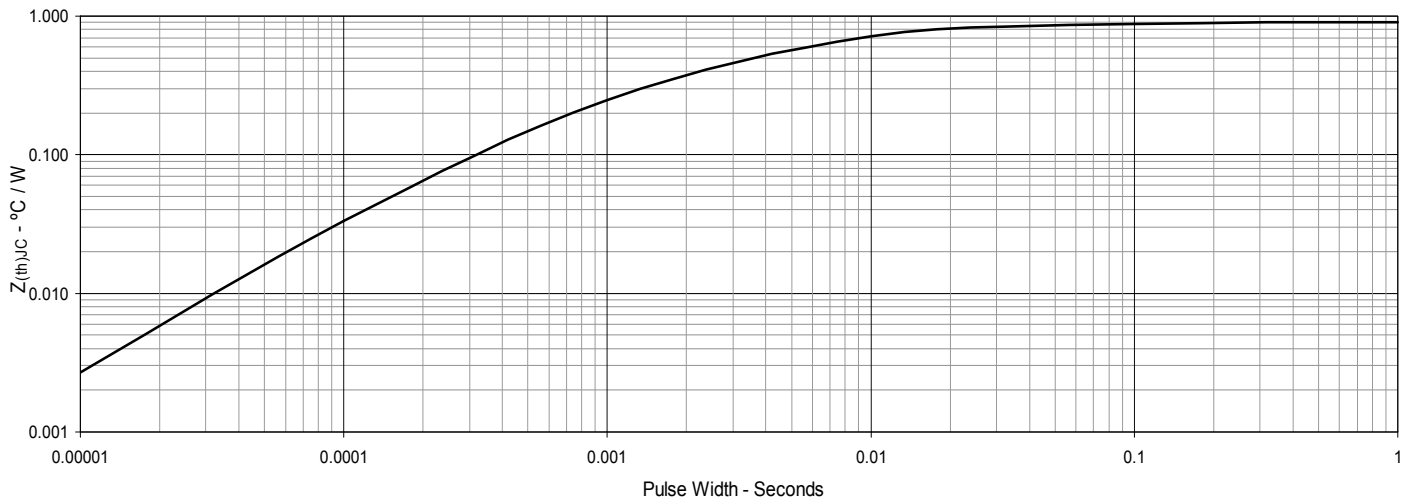

Fig. 7. Transconductance

Fig. 8. Gate Charge

Fig. 9. Capacitance

Fig. 10. Reverse-Bias Safe Operating Area

Fig. 11. Maximum Transient Thermal Impedance for IGBT

IXYS Reserves the Right to Change Limits, Test Conditions and Dimensions.

**Fig. 12. Inductive Switching
Energy Loss vs. Gate Resistance**

**Fig. 13. Inductive Switching
Energy Loss vs. Collector Current**

**Fig. 14. Inductive Switching
Energy Loss vs. Junction Temperature**

**Fig. 15. Inductive Turn-off
Switching Times vs. Gate Resistance**

**Fig. 16. Inductive Turn-off
Switching Times vs. Collector Current**

**Fig. 17. Inductive Turn-off
Switching Times vs. Junction Temperature**

**Fig. 18. Inductive Turn-on
Switching Times vs. Gate Resistance**

**Fig. 19. Inductive Turn-on
Switching Times vs. Collector Current**

**Fig. 20. Inductive Turn-on
Switching Times vs. Junction Temperature**

Fig. 21. Forward Current vs. Forward Voltage

Fig. 22. Maximum Transient Thermal Impedance for Diodes

IXYS Reserves the Right to Change Limits, Test Conditions and Dimensions.



Disclaimer Notice - Information furnished is believed to be accurate and reliable. However, users should independently evaluate the suitability of and test each product selected for their own applications. Littelfuse products are not designed for, and may not be used in, all applications. Read complete Disclaimer Notice at www.littelfuse.com/disclaimer-electronics.