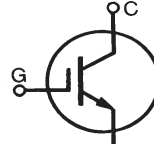
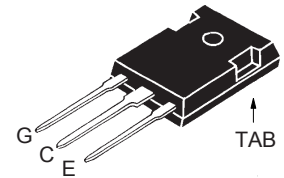

GenX3™ 1200V IGBT
IXGH40N120C3
**High speed PT IGBTs
for 20 - 50 kHz switching**

$$\begin{aligned}
 V_{CES} &= 1200V \\
 I_{C110} &= 40A \\
 V_{CE(sat)} &\leq 4.4V \\
 t_{fi(typ)} &= 57ns
 \end{aligned}$$

| Symbol | Test Conditions | Maximum Ratings | |
|-------------------------------|--|-----------------|------------------|
| V_{CES} | $T_J = 25^\circ\text{C}$ to 150°C | 1200 | V |
| V_{CGR} | $T_J = 25^\circ\text{C}$ to 150°C , $R_{GE} = 1M\Omega$ | 1200 | V |
| V_{GES} | Continuous | ± 20 | V |
| V_{GEM} | Transient | ± 30 | V |
| I_{C25} | $T_C = 25^\circ\text{C}$ (limited by leads) | 75 | A |
| I_{C110} | $T_C = 110^\circ\text{C}$ | 40 | A |
| I_{CM} | $T_C = 25^\circ\text{C}$, 1ms | 200 | A |
| I_A | $T_C = 25^\circ\text{C}$ | 30 | A |
| E_{AS} | $T_C = 25^\circ\text{C}$ | 500 | mJ |
| SSOA (RBSOA) | $V_{GE} = 15V$, $T_J = 125^\circ\text{C}$, $R_G = 3\Omega$ Clamped inductive load @ $V_{CE} \leq 1200V$ | $I_{CM} = 80$ | A |
| P_C | $T_C = 25^\circ\text{C}$ | 380 | W |
| T_J | | -55 ... +150 | $^\circ\text{C}$ |
| T_{JM} | | 150 | $^\circ\text{C}$ |
| T_{stg} | | -55 ... +150 | $^\circ\text{C}$ |
| M_d | Mounting torque | 1.13 / 10 | Nm/lb.in. |
| T_L | Maximum lead temperature for soldering | 300 | $^\circ\text{C}$ |
| T_{SOLD} | 1.6mm (0.062 in.) from case for 10s | 260 | $^\circ\text{C}$ |
| Weight | | 6 | g |

TO-247 (IXGH)

G = Gate C = Collector
E = Emitter TAB = Collector

Features

- International standard packages: JEDEC TO-247AD
- IGBT and anti-parallel FRED in one package
- MOS Gate turn-on - drive simplicity

Applications

- AC motor speed control
- DC servo and robot drives
- DC choppers
- Uninterruptible power supplies (UPS)
- Switch-mode and resonant-mode power supplies

| Symbol | Test Conditions ($T_J = 25^\circ\text{C}$, unless otherwise specified) | Characteristic Values | | |
|---------------|---|-----------------------|------|------------------|
| | | Min. | Typ. | Max. |
| BV_{CES} | $I_C = 250\mu\text{A}$, $V_{GE} = 0V$ | 1200 | | V |
| $V_{GE(th)}$ | $I_C = 250\mu\text{A}$, $V_{CE} = V_{GE}$ | 3.0 | | 5.0 V |
| I_{CES} | $V_{CE} = V_{CES}$ $V_{GE} = 0V$ $T_J = 125^\circ\text{C}$ | | | 75 μA |
| | | | | 1.5 mA |
| I_{GES} | $V_{CE} = 0V$, $V_{GE} = \pm 20V$ | | | ± 100 nA |
| $V_{CE(sat)}$ | $I_C = 30A$, $V_{GE} = 15V$, Note 1 $T_J = 125^\circ\text{C}$ | | | 4.4 V |
| | | | 2.7 | V |

| Symbol | Test Conditions ($T_J = 25^\circ\text{C}$, unless otherwise specified) | Characteristic Values | | |
|--------------|---|-----------------------|------|-----------|
| | | Min. | Typ. | Max. |
| g_{fs} | $I_C = 30\text{A}, V_{CE} = 10\text{V}$, Note 1 | 18 | 30 | S |
| C_{ies} | $V_{CE} = 25\text{V}, V_{GE} = 0\text{V}, f = 1\text{MHz}$ | | 2930 | pF |
| C_{oes} | | | 225 | pF |
| C_{res} | | | 93 | pF |
| Q_g | $I_C = 40\text{A}, V_{GE} = 15\text{V}, V_{CE} = 0.5 \cdot V_{CES}$ | | 142 | nC |
| Q_{ge} | | | 19 | nC |
| Q_{gc} | | | 62 | nC |
| $t_{d(on)}$ | Inductive load, $T_J = 25^\circ\text{C}$ $I_C = 30\text{A}, V_{GE} = 15\text{V}$ $V_{CE} = 600\text{V}, R_G = 3\Omega$ Note 1 | | 17 | ns |
| t_{ri} | | | 33 | ns |
| E_{on} | | | 1.8 | mJ |
| $t_{d(off)}$ | | | 130 | ns |
| t_{fi} | | | 57 | ns |
| E_{off} | | 0.55 | 1.0 | mJ |
| $t_{d(on)}$ | Inductive load, $T_J = 125^\circ\text{C}$ $I_C = 30\text{A}, V_{GE} = 15\text{V}$ $V_{CE} = 600\text{V}, R_G = 3\Omega$ Note 1 | | 17 | ns |
| t_{ri} | | | 35 | ns |
| E_{on} | | | 3.5 | mJ |
| $t_{d(off)}$ | | | 177 | ns |
| t_{fi} | | | 298 | ns |
| E_{off} | | 1.6 | mJ | |
| R_{thJC} | | | | 0.33 °C/W |
| R_{thCK} | | 0.21 | | °C/W |

TO-247 (IXGH) Outline

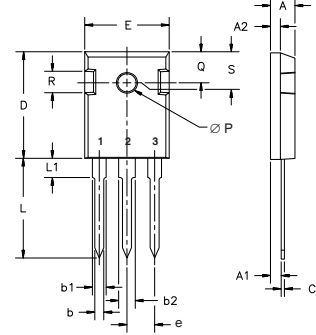

Terminals: 1 - Gate 2 - Drain
3 - Source Tab - Drain

| Dim. | Millimeter | | Inches | |
|----------------|------------|-------|--------|-------|
| | Min. | Max. | Min. | Max. |
| A | 4.7 | 5.3 | .185 | .209 |
| A ₁ | 2.2 | 2.54 | .087 | .102 |
| A ₂ | 2.2 | 2.6 | .059 | .098 |
| b | 1.0 | 1.4 | .040 | .055 |
| b ₁ | 1.65 | 2.13 | .065 | .084 |
| b ₂ | 2.87 | 3.12 | .113 | .123 |
| C | .4 | .8 | .016 | .031 |
| D | 20.80 | 21.46 | .819 | .845 |
| E | 15.75 | 16.26 | .610 | .640 |
| e | 5.20 | 5.72 | 0.205 | 0.225 |
| L | 19.81 | 20.32 | .780 | .800 |
| L1 | | 4.50 | | .177 |
| ∅P | 3.55 | 3.65 | .140 | .144 |
| Q | 5.89 | 6.40 | 0.232 | 0.252 |
| R | 4.32 | 5.49 | .170 | .216 |
| S | 6.15 | BSC | 242 | BSC |

Notes: 1. Pulse test, $t \leq 300\mu\text{s}$; duty cycle, $d \leq 2\%$.

PRELIMINARY TECHNICAL INFORMATION

The product presented herein is under development. The Technical Specifications offered are derived from data gathered during objective characterizations of preliminary engineering lots; but also may yet contain some information supplied during a pre-production design evaluation. IXYS reserves the right to change limits, test conditions, and dimensions without notice.

IXYS reserves the right to change limits, test conditions, and dimensions.

IXYS MOSFETs and IGBTs are covered 4,835,592 4,931,844 5,049,961 5,237,481 6,162,665 6,404,065 B1 6,683,344 6,727,585 7,005,734 B2 7,157,338B2
by one or more of the following U.S. patents: 4,850,072 5,017,508 5,063,307 5,381,025 6,259,123 B1 6,534,343 6,710,405 B2 6,759,692 7,063,975 B2
4,881,106 5,034,796 5,187,117 5,486,715 6,306,728 B1 6,583,505 6,710,463 6,771,478 B2 7,071,537

**Fig. 1. Output Characteristics
@ 25°C**

**Fig. 2. Extended Output Characteristics
@ 25°C**

**Fig. 3. Output Characteristics
@ 125°C**

**Fig. 4. Dependence of $V_{CE(sat)}$ on
Junction Temperature**

**Fig. 5. Collector-to-Emitter Voltage
vs. Gate-to-Emitter Voltage**

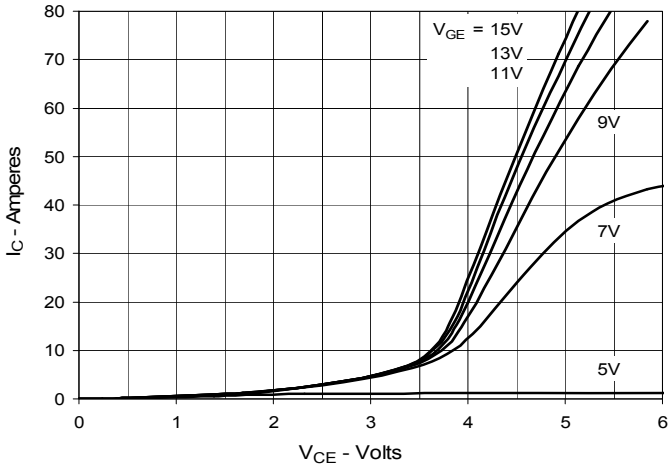
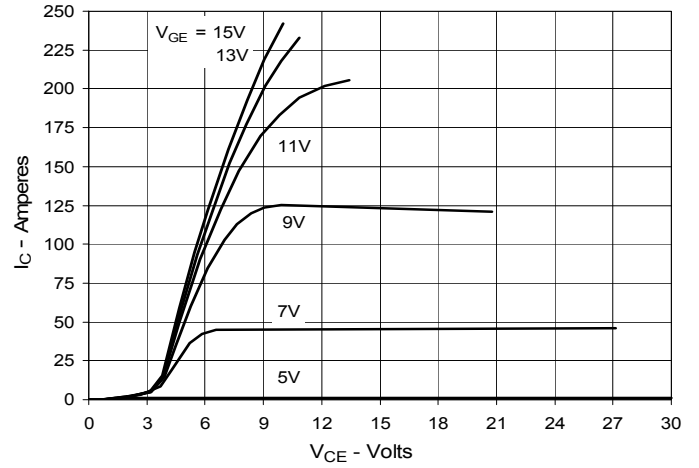
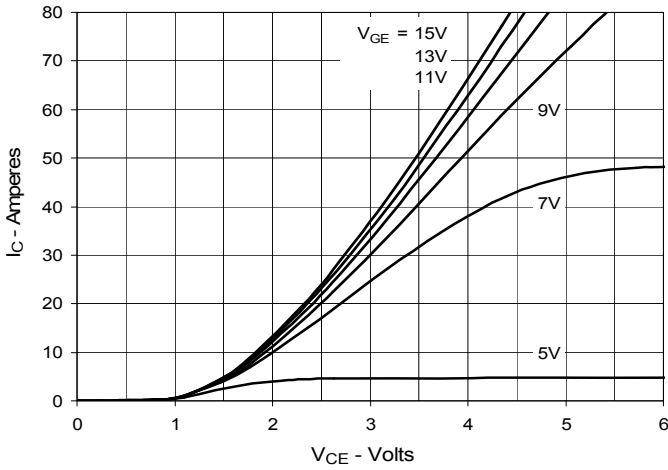
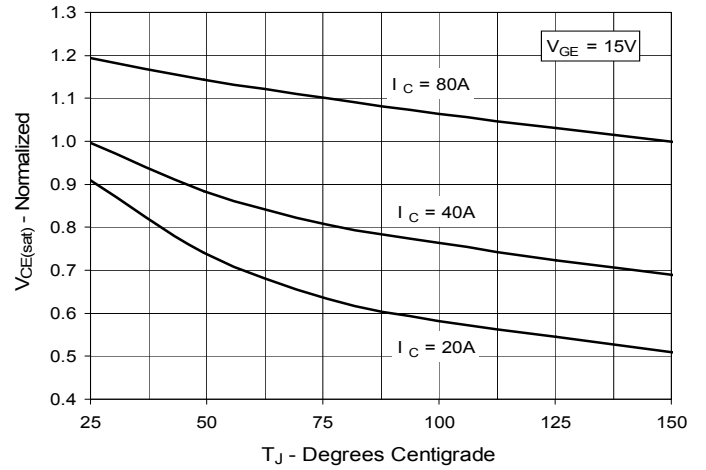
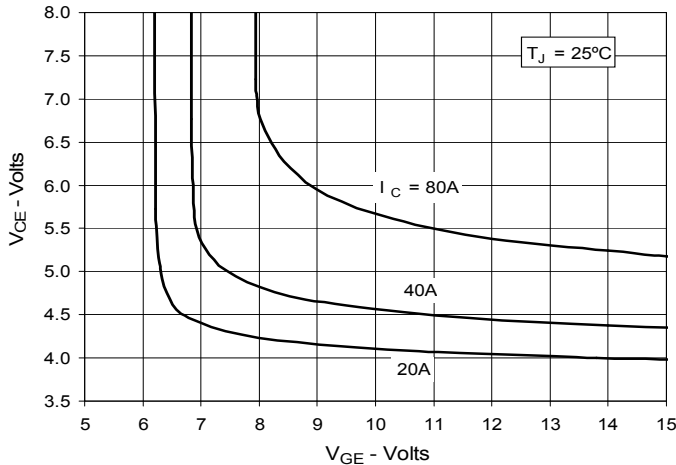
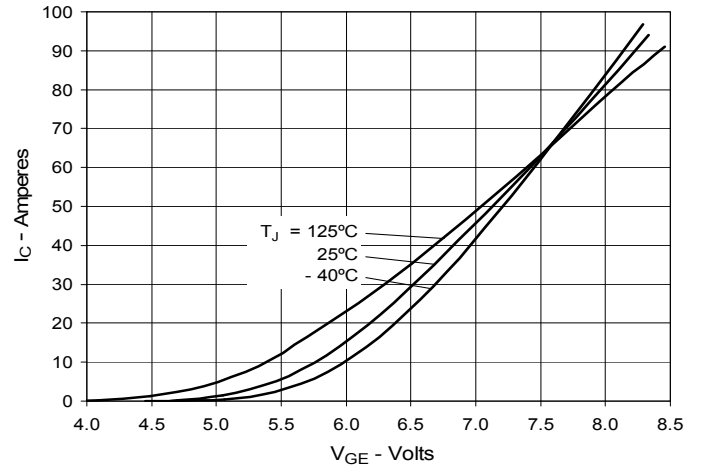
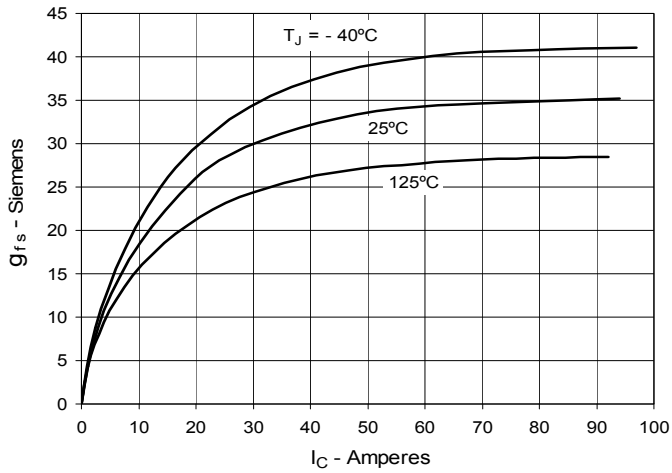
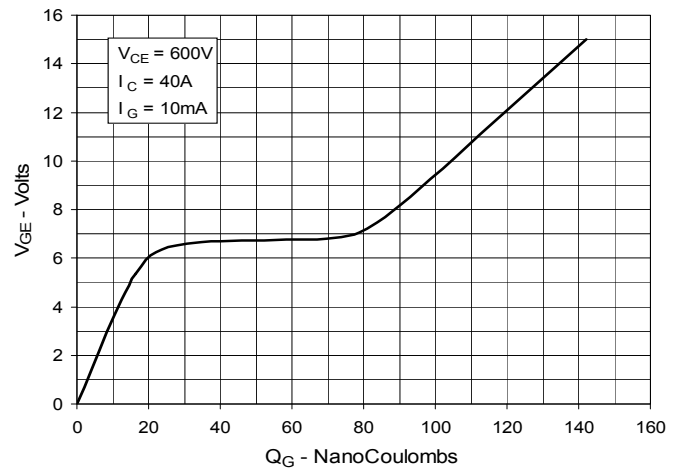
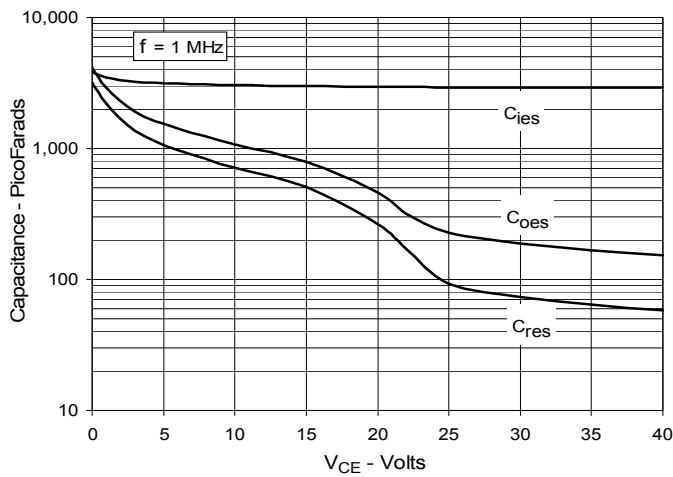
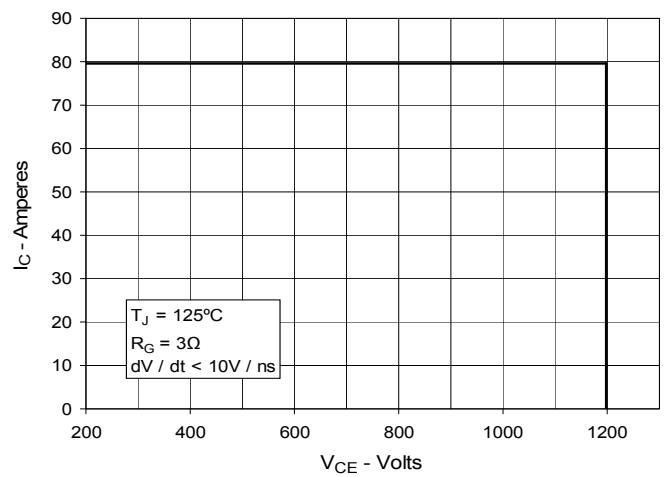
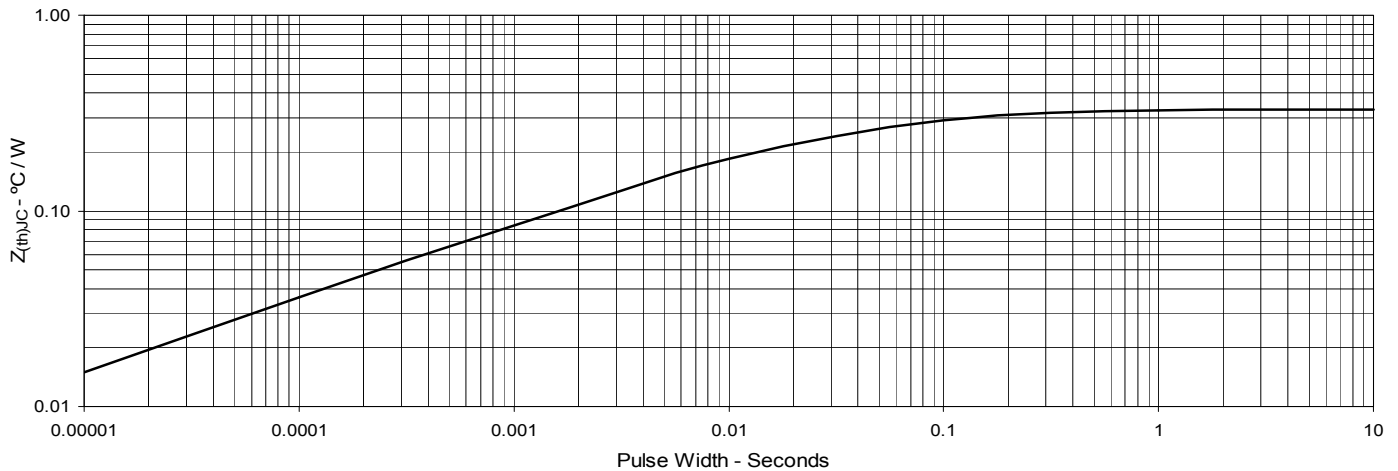
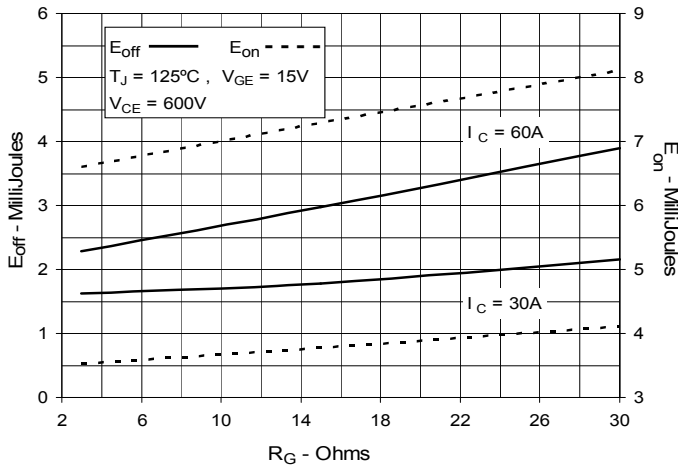
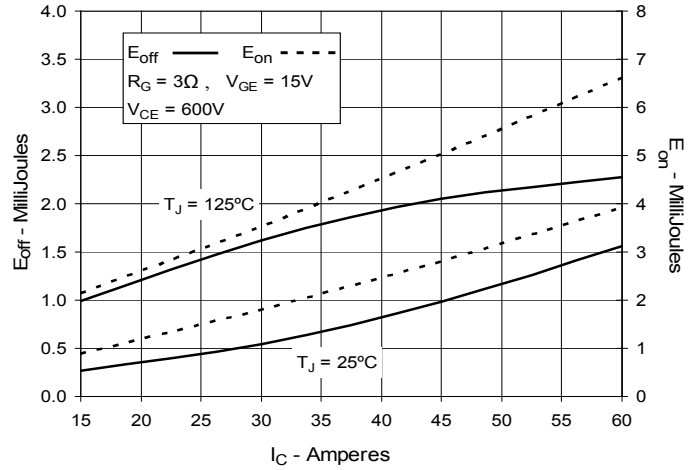
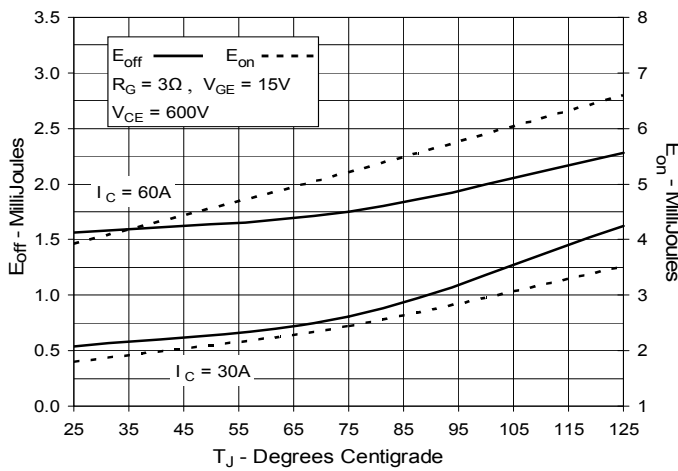
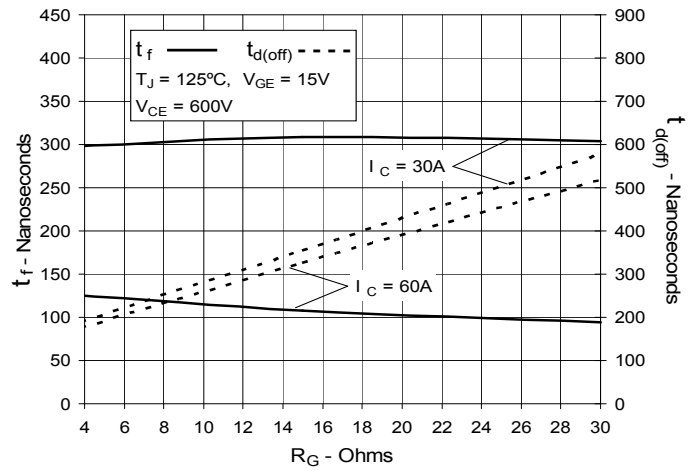
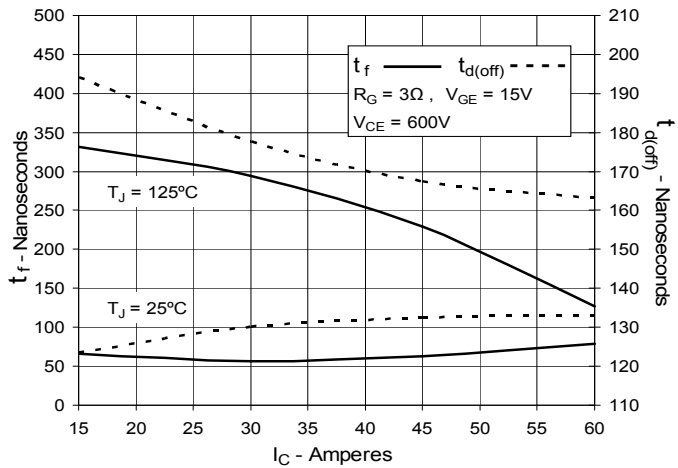
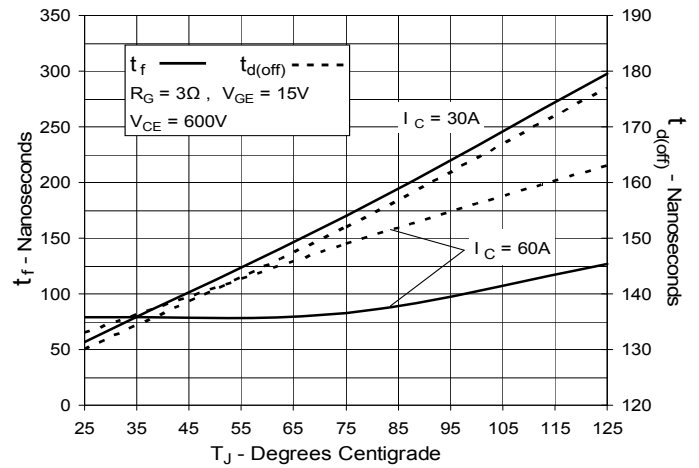
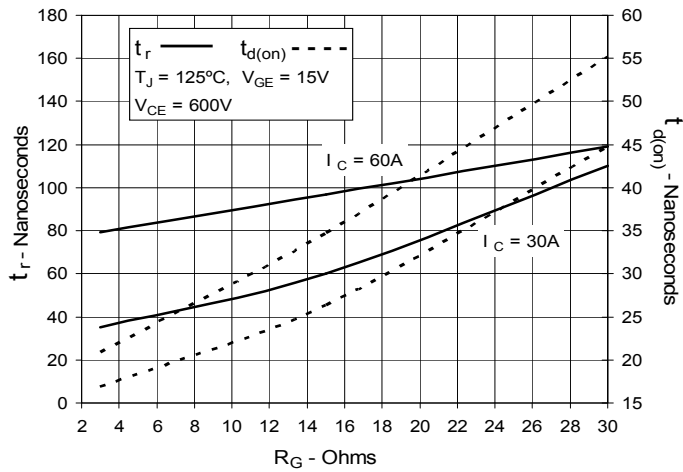
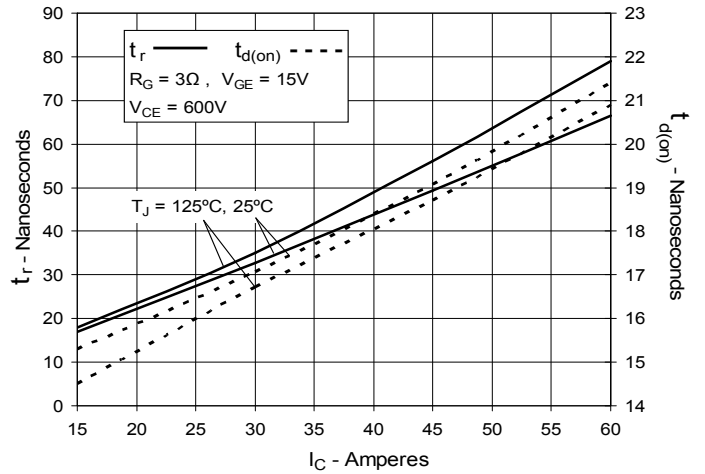
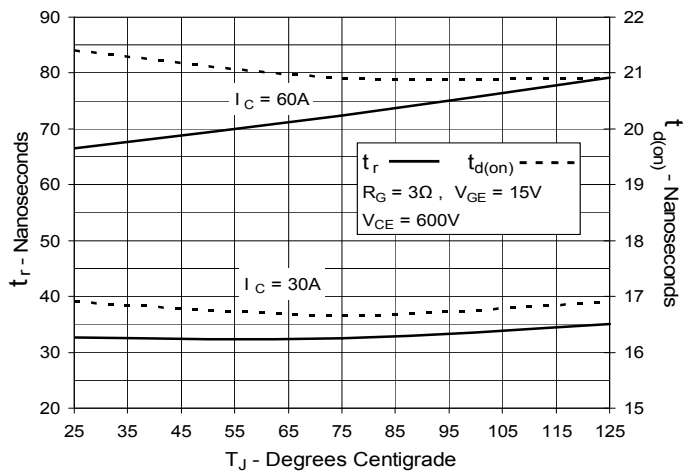
Fig. 6. Input Admittance

Fig. 7. Transconductance

Fig. 8. Gate Charge

Fig. 9. Capacitance

Fig. 10. Reverse-Bias Safe Operating Area

Fig. 11. Maximum Transient Thermal Impedance

IXYS reserves the right to change limits, test conditions, and dimensions.

Fig. 12. Inductive Switching Energy Loss vs. Gate Resistance

Fig. 13. Inductive Switching Energy Loss vs. Collector Current

Fig. 14. Inductive Switching Energy Loss vs. Junction Temperature

Fig. 15. Inductive Turn-off Switching Times vs. Gate Resistance

Fig. 16. Inductive Turn-off Switching Times vs. Collector Current

Fig. 17. Inductive Turn-off Switching Times vs. Junction Temperature

**Fig. 18. Inductive Turn-on
Switching Times vs. Gate Resistance**

**Fig. 19. Inductive Turn-on
Switching Times vs. Collector Current**

**Fig. 20. Inductive Turn-on
Switching Times vs. Junction Temperature**



Disclaimer Notice - Information furnished is believed to be accurate and reliable. However, users should independently evaluate the suitability of and test each product selected for their own applications. Littelfuse products are not designed for, and may not be used in, all applications. Read complete Disclaimer Notice at www.littelfuse.com/disclaimer-electronics.