

HiPerFAST™ IGBT

IXGH 30N60C2
IXGT 30N60C2

C2-Class High Speed IGBTs

V_{CES} = 600 V
I_{C25} = 70 A
V_{CE(sat)} = 2.7 V
t_{fi}typ = 32 ns

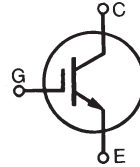

Symbol	Test Conditions	Maximum Ratings	
V _{CES}	T _J = 25°C to 150°C	600	V
V _{CGR}	T _J = 25°C to 150°C; R _{GE} = 1 MΩ	600	V
V _{GES}	Continuous	±20	V
V _{GEM}	Transient	±30	V
I _{C25}	T _C = 25°C (limited by leads)	70	A
I _{C110}	T _C = 110°C	30	A
I _{CM}	T _C = 25°C, 1 ms	150	A
SSOA (RBSOA)	V _{GE} = 15 V, T _{VJ} = 125°C, R _G = 10 Ω Clamped inductive load @ ≤ 600 V	I _{CM} = 60	A
P _C	T _C = 25°C	190	W
T _J		-55 ... +150	°C
T _{JM}		150	°C
T _{stg}		-55 ... +150	°C
Maximum lead temperature for soldering 1.6 mm (0.062 in.) from case for 10 s		300	°C
Plastic body for 10s		250	°C
M _d	Mounting torque (M3) (TO-247)	1.13/10Nm/lb.in.	
Weight	TO-247	6	g
	TO-268	4	g

TO-268 (IXGT)

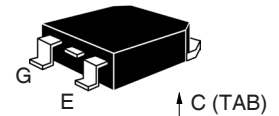

TO-247 (IXGH)

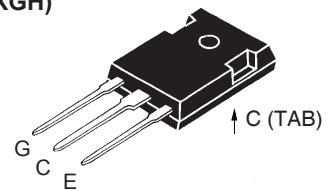

G = Gate, C = Collector,
E = Emitter, TAB = Collector

Features

- Very high frequency IGBT
- Square RBSOA
- High current handling capability
- MOS Gate turn-on - drive simplicity

Applications

- PFC circuits
- Uninterruptible power supplies (UPS)
- Switched-mode and resonant-mode power supplies
- AC motor speed control
- DC servo and robot drives
- DC choppers

Symbol	Test Conditions	Characteristic Values (T _J = 25°C, unless otherwise specified)		
		min.	typ.	max.
V _{GE(th)}	I _C = 250 μA, V _{CE} = V _{GE}	2.5		5.0 V
I _{CES}	V _{CE} = V _{CES} V _{GE} = 0 V			50 μA 1 mA
I _{GES}	V _{CE} = 0 V, V _{GE} = ±20 V			±100 nA
V _{CE(sat)}	I _C = 24 A, V _{GE} = 15 V		2.0	2.7 V V

Symbol	Test Conditions	Characteristic Values ($T_J = 25^\circ\text{C}$, unless otherwise specified)			
		min.	typ.	max.	
g_{fs}	$I_C = 24\text{ A}; V_{CE} = 10\text{ V}$, Pulse test, $t \leq 300\ \mu\text{s}$, duty cycle $\leq 2\%$	18	28	S	
C_{ies} C_{oes} C_{res}	$V_{CE} = 25\text{ V}, V_{GE} = 0\text{ V}, f = 1\text{ MHz}$		1430	pF	
			110	pF	
			40	pF	
Q_g Q_{ge} Q_{gc}	$I_C = 24\text{ A}, V_{GE} = 15\text{ V}, V_{CE} = 300\text{ V}$		70	nC	
			10	nC	
			23	nC	
$t_{d(on)}$ t_{ri} $t_{d(off)}$ t_{fi} E_{off}	Inductive load, $T_J = 25^\circ\text{C}$ $I_C = 24\text{ A}, V_{GE} = 15\text{ V}$ $V_{CE} = 400\text{ V}, R_G = 5\ \Omega$		13	ns	
			15	ns	
			70	140	ns
			60	ns	
			0.29	0.30	mJ
$t_{d(on)}$ t_{ri} E_{on} $t_{d(off)}$ t_{fi} E_{off}	Inductive load, $T_J = 125^\circ\text{C}$ $I_C = 24\text{ A}, V_{GE} = 15\text{ V}$ $V_{CE} = 400\text{ V}, R_G = 5\ \Omega$		13	ns	
			17	ns	
			0.22	mJ	
			120	ns	
			130	ns	
			0.59	mJ	
R_{thJC} R_{thCK}	(TO-247)			0.65 KW KW	
		0.25			

Min. Recommended Footprint (Dimensions in inches and mm)

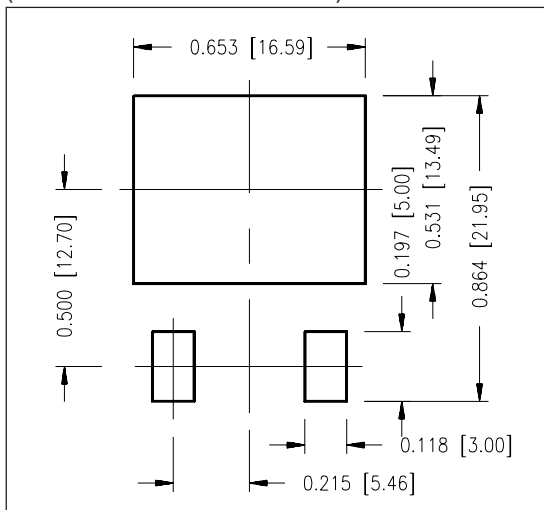

TO-247 AD Outline

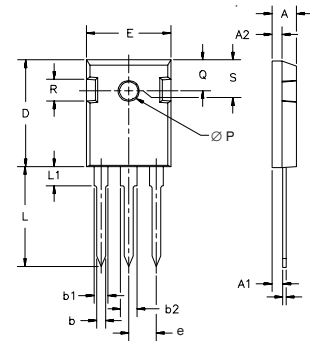

Dim.	Millimeter		Inches	
	Min.	Max.	Min.	Max.
A	4.7	5.3	.185	.209
A ₁	2.2	2.54	.087	.102
A ₂	2.2	2.6	.059	.098
b	1.0	1.4	.040	.055
b ₁	1.65	2.13	.065	.084
b ₂	2.87	3.12	.113	.123
C	.4	.8	.016	.031
D	20.80	21.46	.819	.845
E	15.75	16.26	.610	.640
e	5.20	5.72	0.205	0.225
L	19.81	20.32	.780	.800
L ₁		4.50		.177
∅P	3.55	3.65	.140	.144
Q	5.89	6.40	0.232	0.252
R	4.32	5.49	.170	.216
S	6.15	BSC	.242	BSC

TO-268 Outline

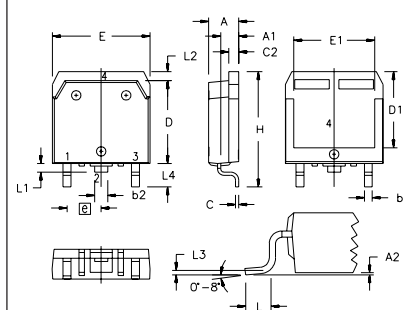

SYM	INCHES		MILLIMETERS	
	MIN	MAX	MIN	MAX
A	.193	.201	4.90	5.10
A ₁	.106	.114	2.70	2.90
A ₂	.001	.010	0.02	0.25
b	.045	.057	1.15	1.45
b ₂	.075	.083	1.90	2.10
C	.016	.026	0.40	0.65
C ₂	.057	.063	1.45	1.60
D	.543	.551	13.80	14.00
D ₁	.488	.500	12.40	12.70
E	.624	.632	15.85	16.05
E ₁	.524	.535	13.30	13.60
e	.215 BSC		5.45 BSC	
H	.736	.752	18.70	19.10
L	.094	.106	2.40	2.70
L ₁	.047	.055	1.20	1.40
L ₂	.039	.045	1.00	1.15
L ₃	.010 BSC		0.25 BSC	
L ₄	.150	.161	3.80	4.10

IXYS reserves the right to change limits, test conditions, and dimensions.

IXYS MOSFETs and IGBTs are covered by one or more of the following U.S. patents:	4,835,592	4,931,844	5,049,961	5,237,481	6,162,665	6,404,065 B1	6,683,344	6,727,585
	4,850,072	5,017,508	5,063,307	5,381,025	6,259,123 B1	6,534,343	6,710,405 B2	6,759,692
	4,881,106	5,034,796	5,187,117	5,486,715	6,306,728 B1	6,583,505	6,710,463	6,771,478 B2

**Fig. 1. Output Characteristics
@ 25 Deg. C**

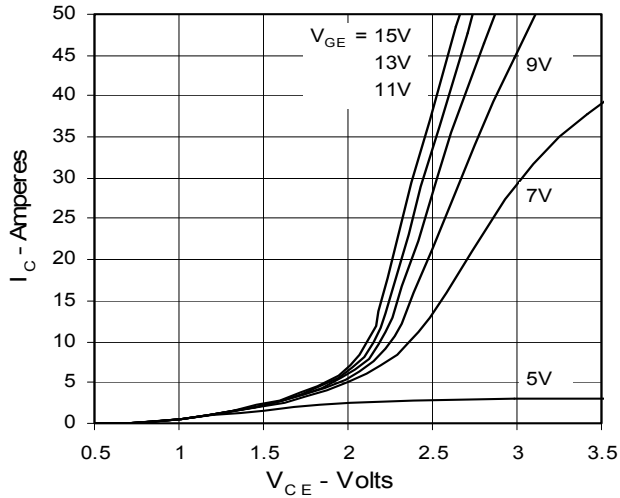

**Fig. 2. Extended Output Characteristics
@ 25 deg. C**

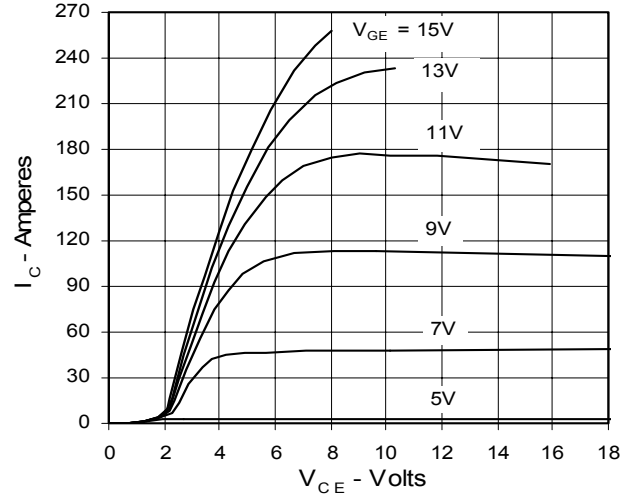

**Fig. 3. Output Characteristics
@ 125 Deg. C**

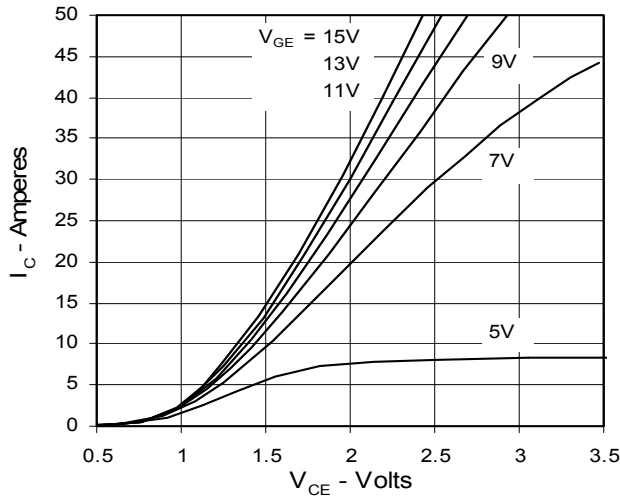

**Fig. 4. Dependence of $V_{CE(sat)}$ on
Temperature**

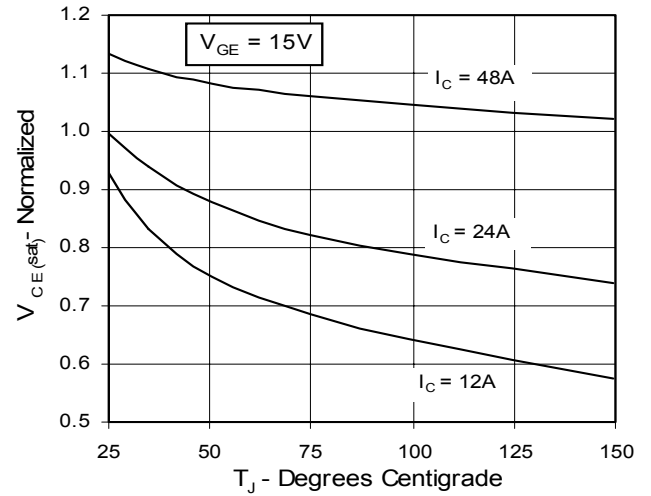

**Fig. 5. Collector-to-Emitter Voltage
vs. Gate-to-Emitter voltage**

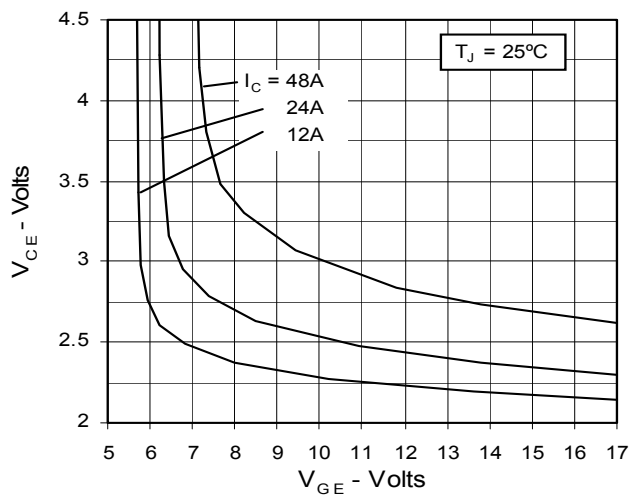

Fig. 6. Input Admittance

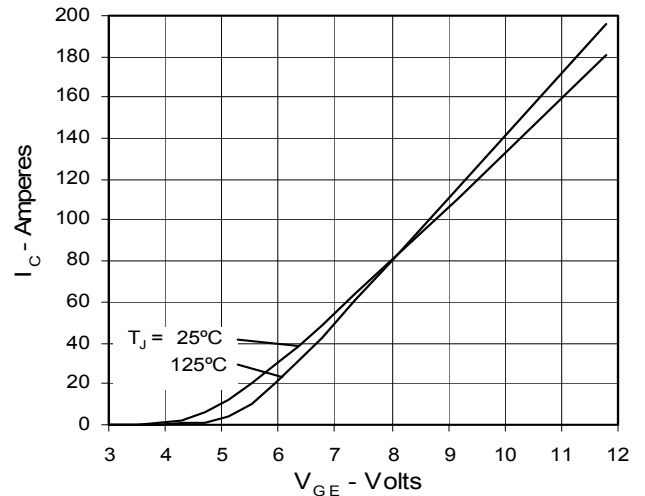

Fig. 7. Transconductance

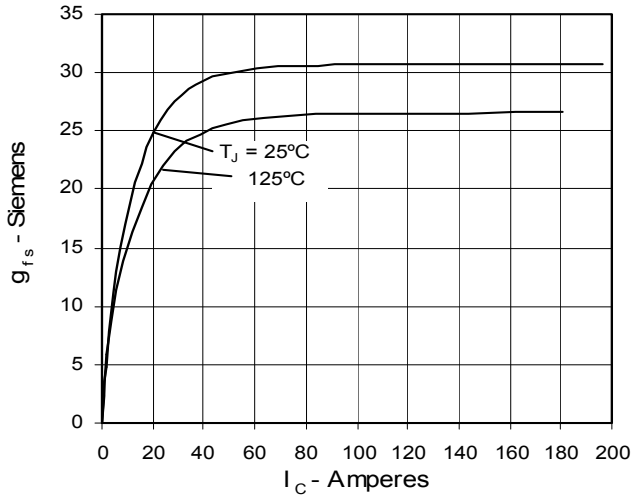

Fig. 8. Dependence of Turn-Off Energy on R_G

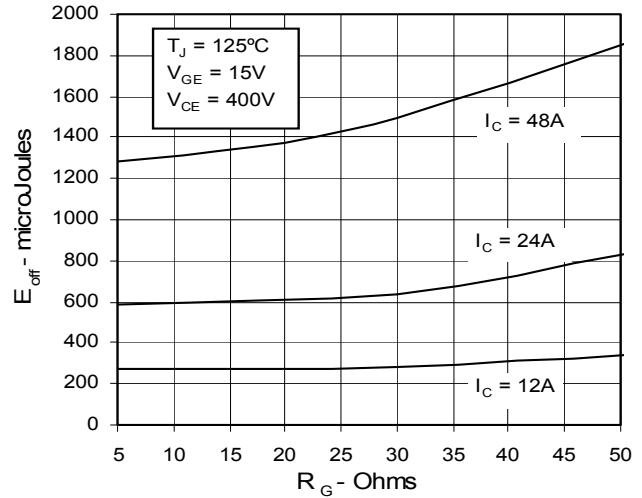

Fig. 9. Dependence of Turn-Off Energy on I_C

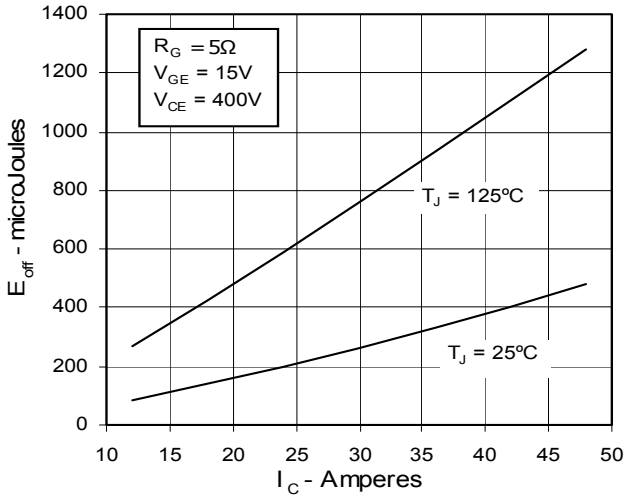

Fig. 10. Dependence of Turn-Off Energy on Temperature

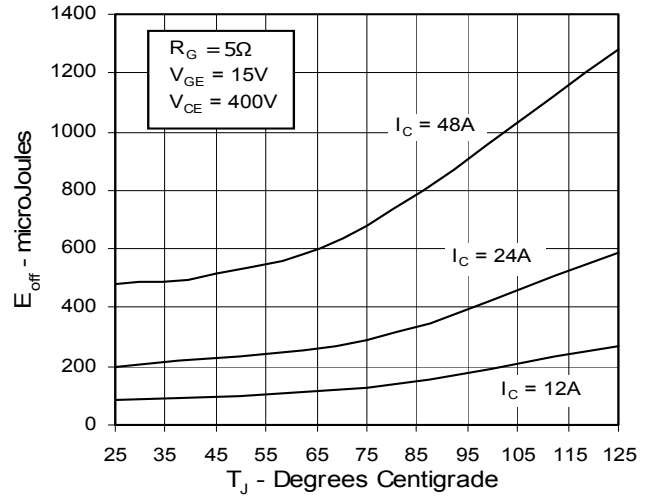

Fig. 11. Dependence of Turn-Off Switching Time on R_G

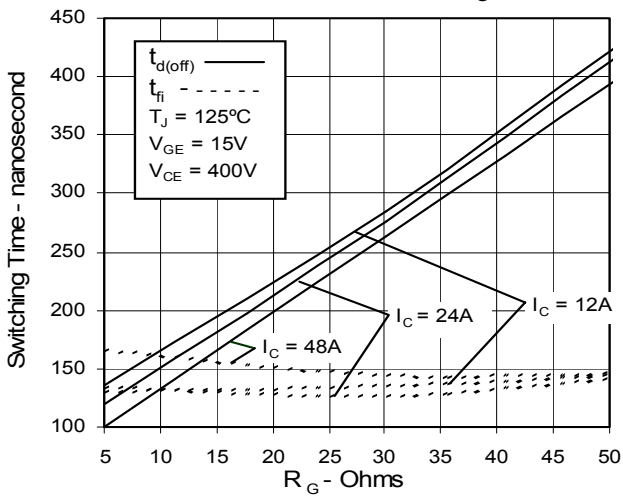

Fig. 12. Dependence of Turn-Off Switching Time on I_C

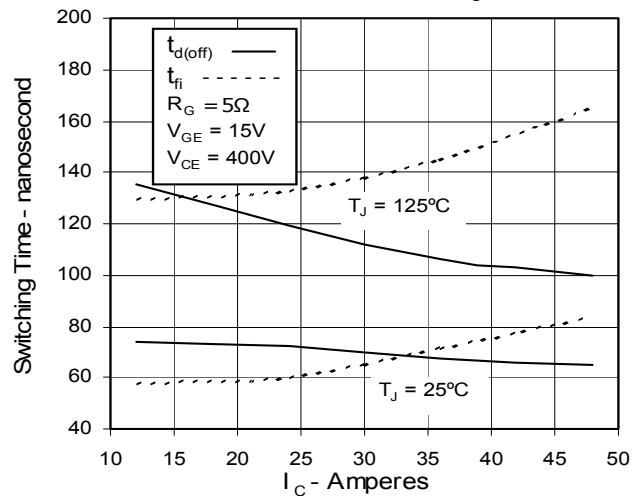

Fig. 13. Dependence of Turn-Off Switching Time on Temperature

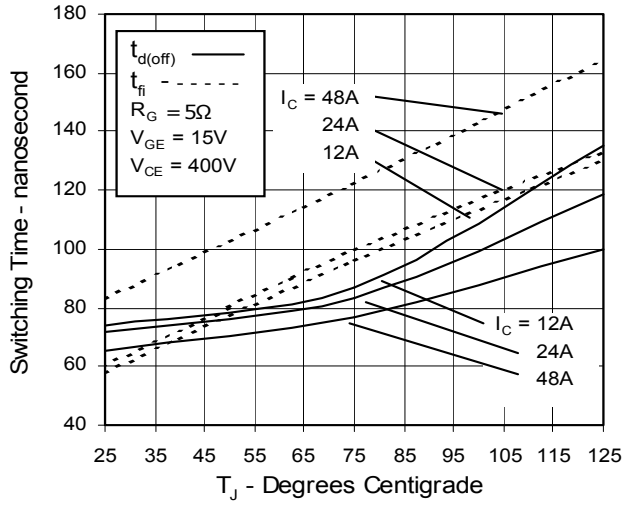

Fig. 14. Gate Charge

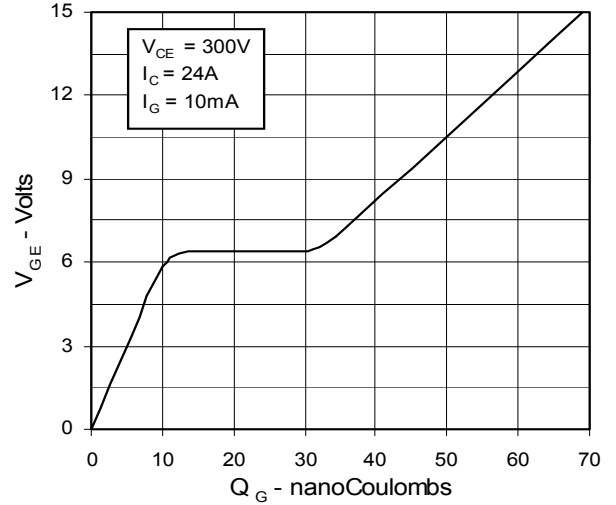

Fig. 15. Capacitance

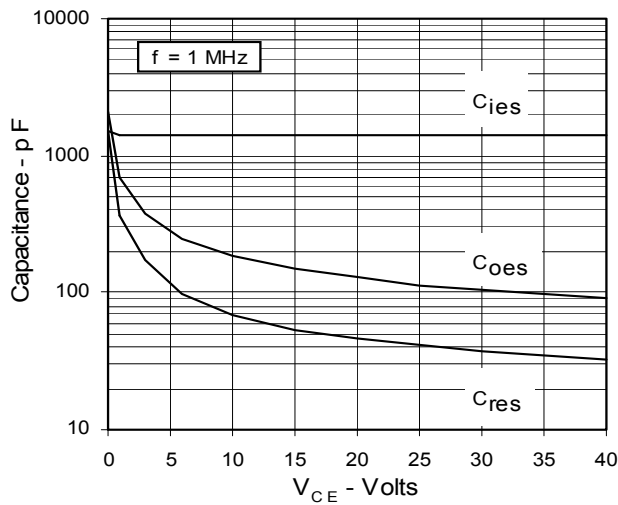
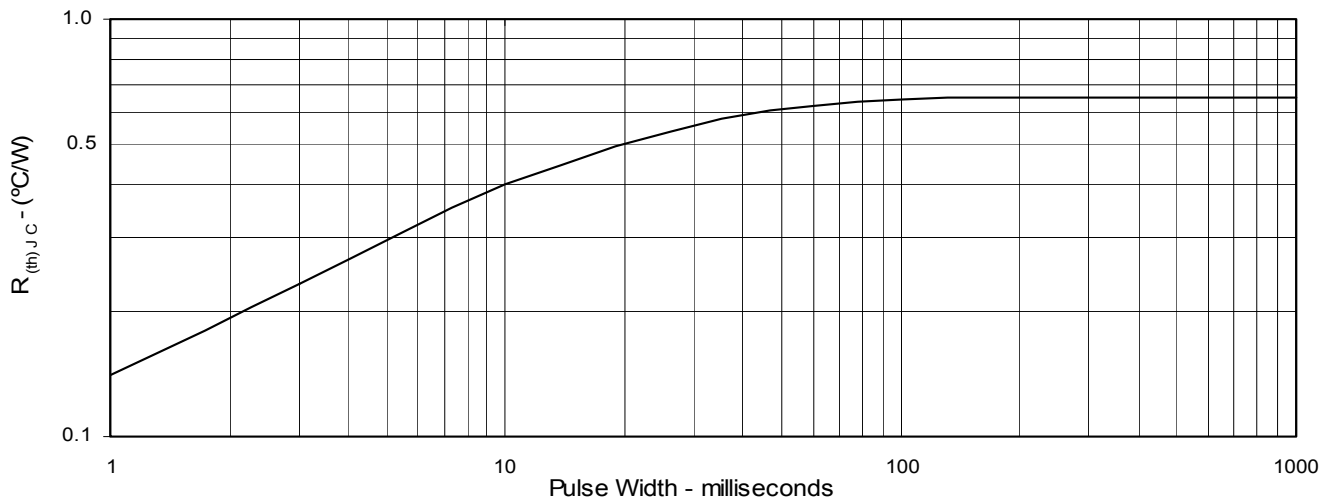

Fig. 16. Maximum Transient Thermal Resistance





Disclaimer Notice - Information furnished is believed to be accurate and reliable. However, users should independently evaluate the suitability of and test each product selected for their own applications. Littelfuse products are not designed for, and may not be used in, all applications. Read complete Disclaimer Notice at www.littelfuse.com/disclaimer-electronics.