

# High Voltage IGBTs

## IXGK75N250

## IXGX75N250

### For Capacitor Discharge Applications

$$V_{CES} = 2500V$$

$$I_{C110} = 75A$$

$$V_{CE(sat)} \leq 2.7V$$

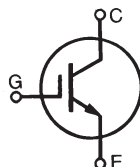

Symbol	Test Conditions	Maximum Ratings	
$V_{CES}$	$T_J = 25^\circ C$ to $150^\circ C$	2500	V
$V_{CGR}$	$T_J = 25^\circ C$ to $150^\circ C$ , $R_{GE} = 1M\Omega$	2500	V
$V_{GES}$	Continuous	$\pm 20$	V
$V_{GEM}$	Transient	$\pm 30$	V
$I_{C25}$	$T_C = 25^\circ C$ ( Chip Capability )	170	A
$I_{C110}$	$T_C = 110^\circ C$	75	A
$I_{LRMS}$	$T_C = 25^\circ C$ (Lead RMS Limit)	160	A
$I_{CM}$	$T_C = 25^\circ C$ , $V_{GE} = 20V$ , 1ms	530	A
<b>SSOA</b> <b>(RBSOA)</b>	$V_{GE} = 15V$ , $T_{VJ} = 125^\circ C$ , $R_G = 1\Omega$ Clamped Inductive Load	$I_{CM} = 200$ @ $0.8 \cdot V_{CES}$	A
$P_C$	$T_C = 25^\circ C$	780	W
$T_J$		-55 ... +150	$^\circ C$
$T_{JM}$		150	$^\circ C$
$T_{stg}$		-55 ... +150	$^\circ C$
$T_L$	Maximum Lead Temperature for Soldering	300	$^\circ C$
$T_{SOLD}$	1.6 mm (0.062 in.) from Case for 10	260	$^\circ C$
$M_d$	Mounting Torque ( IXGK )	1.13/10	Nm/lb.in.
$F_c$	Mounting Force ( IXGX )	20..120/4.5..27	N/lb.
<b>Weight</b>	TO-264	10	g
	PLUS247	6	g

TO-264 (IXGK)

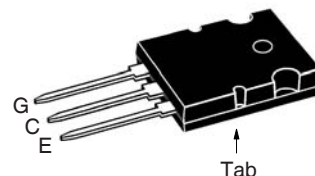

PLUS247™ (IXGX)

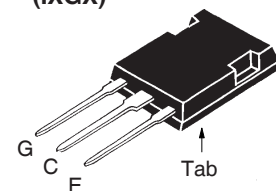

G = Gate                      E = Emitter  
C = Collector                Tab = Collector

#### Features

- Very High Peak Current Capability
- Low Saturation Voltage
- MOS Gate Turn-On
- Rugged NPT Structure
- Molding Epoxies meet UL 94V-0 Flammability Classification

#### Advantages

- Easy to Mount
- Space Savings
- High Power Density

#### Applications

- Capacitor Discharge
- Pulser Circuits

Symbol	Test Conditions ( $T_J = 25^\circ C$ , Unless Otherwise Specified)	Characteristic Values		
		Min.	Typ.	Max.
$BV_{CES}$	$I_C = 1mA$ , $V_{CE} = 0V$	2500		V
$V_{GE(th)}$	$I_C = 4mA$ , $V_{CE} = V_{GE}$	3.0		5.0 V
$I_{CES}$	$V_{CE} = V_{CES}$ , $V_{GE} = 0V$ $T_J = 125^\circ C$			50 $\mu A$ 5 mA
$I_{GES}$	$V_{CE} = 0V$ , $V_{GE} = \pm 20V$			$\pm 200$ nA
$V_{CE(sat)}$	$I_C = 75A$ , $V_{GE} = 15V$ , Note 1 $I_C = 150A$			2.7 V 3.6 V

Symbol	Test Conditions ( $T_J = 25^\circ\text{C}$ , Unless Otherwise Specified)	Characteristic Values		
		Min.	Typ.	Max.
$g_{fs}$	$I_C = 60\text{A}$ , $V_{CE} = 10\text{V}$ , Note 1	35	58	S
$C_{ies}$	$V_{CE} = 25\text{V}$ , $V_{GE} = 0\text{V}$ , $f = 1\text{MHz}$		9000	pF
$C_{oes}$			345	pF
$C_{res}$			110	pF
$Q_g$	$I_C = 75\text{A}$ , $V_{GE} = 15\text{V}$ , $V_{CE} = 0.5 \cdot V_{CES}$		410	nC
$Q_{ge}$			63	nC
$Q_{gc}$			175	nC
$t_{d(on)}$	<b>Resistive Switching Times</b> $I_C = 150\text{A}$ , $V_{GE} = 15\text{V}$ $V_{CE} = 1250\text{V}$ , $R_G = 1\Omega$		55	ns
$t_r$			225	ns
$t_{d(off)}$			270	ns
$t_f$			455	ns
$R_{thJC}$			0.16	$^\circ\text{C/W}$
$R_{thCK}$		0.15		$^\circ\text{C/W}$

Note 1. Pulse test,  $t \leq 300\mu\text{s}$ , duty cycle,  $d \leq 2\%$ .

\*Additional provision for lead-to-lead voltage isolation are required at  $V_{CE} > 1200\text{V}$ .

### PRELIMINARY TECHNICAL INFORMATION

The product presented herein is under development. The Technical Specifications offered are derived from data gathered during objective characterizations of preliminary engineering lots; but also may yet contain some information supplied during a pre-production design evaluation. IXYS reserves the right to change limits, test conditions, and dimensions without notice.

IXYS Reserves the Right to Change Limits, Test Conditions, and Dimensions.

IXYS MOSFETs and IGBTs are covered by one or more of the following U.S. patents:

4,835,592	4,931,844	5,049,961	5,237,481	6,162,665	6,404,065 B1	6,683,344	6,727,585	7,005,734 B2	7,157,338B2
4,850,072	5,017,508	5,063,307	5,381,025	6,259,123 B1	6,534,343	6,710,405 B2	6,759,692	7,063,975 B2	
4,881,106	5,034,796	5,187,117	5,486,715	6,306,728 B1	6,583,505	6,710,463	6,771,478 B2	7,071,537	

### TO-264 AA (IXGK) Outline

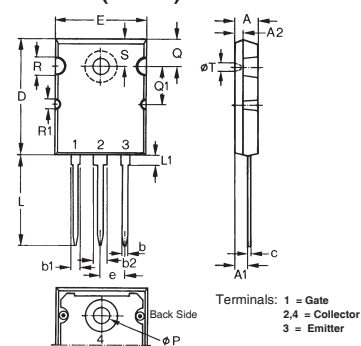

Dim.	Millimeter		Inches	
	Min.	Max.	Min.	Max.
A	4.82	5.13	.190	.202
A1	2.54	2.89	.100	.114
A2	2.00	2.10	.079	.083
b	1.12	1.42	.044	.056
b1	2.39	2.69	.094	.106
b2	2.90	3.09	.114	.122
c	0.53	0.83	.021	.033
D	25.91	26.16	1.020	1.030
E	19.81	19.96	.780	.786
e	5.46 BSC		.215 BSC	
J	0.00	0.25	.000	.010
K	0.00	0.25	.000	.010
L	20.32	20.83	.800	.820
L1	2.29	2.59	.090	.102
P	3.17	3.66	.125	.144
Q	6.07	6.27	.239	.247
Q1	8.38	8.69	.330	.342
R	3.81	4.32	.150	.170
R1	1.78	2.29	.070	.090
S	6.04	6.30	.238	.248
T	1.57	1.83	.062	.072

### PLUS247™ (IXGX) Outline

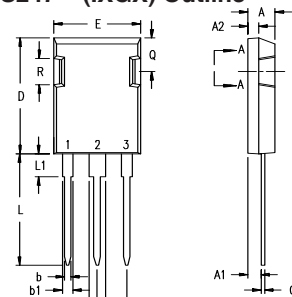

Terminals: 1 - Gate  
2 - Collector  
3 - Emitter

Dim.	Millimeter		Inches	
	Min.	Max.	Min.	Max.
A	4.83	5.21	.190	.205
A <sub>1</sub>	2.29	2.54	.090	.100
A <sub>2</sub>	1.91	2.16	.075	.085
b	1.14	1.40	.045	.055
b <sub>1</sub>	1.91	2.13	.075	.084
b <sub>2</sub>	2.92	3.12	.115	.123
C	0.61	0.80	.024	.031
D	20.80	21.34	.819	.840
E	15.75	16.13	.620	.635
e	5.45 BSC		.215 BSC	
L	19.81	20.32	.780	.800
L1	3.81	4.32	.150	.170
Q	5.59	6.20	.220	0.244
R	4.32	4.83	.170	.190

**Fig. 1. Output Characteristics @  $T_J = 25^\circ\text{C}$**

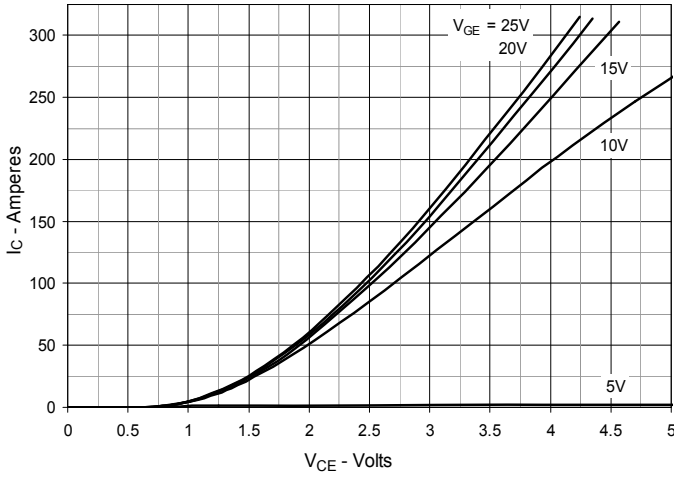

**Fig. 2. Output Characteristics @  $T_J = 125^\circ\text{C}$**

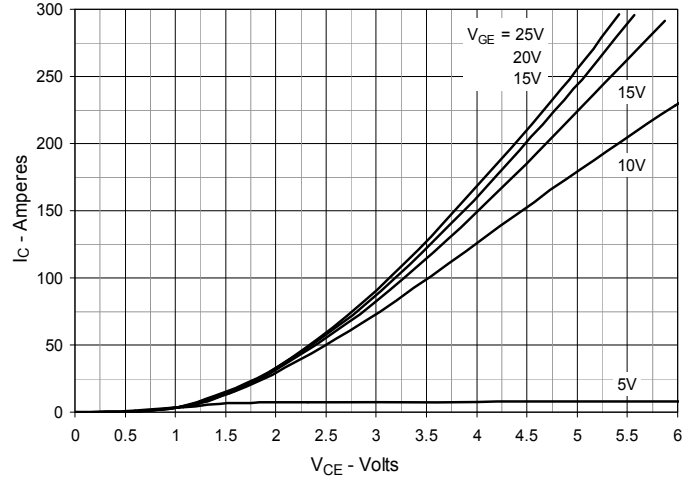

**Fig. 3. Dependence of  $V_{CE(sat)}$  on Junction Temperature**

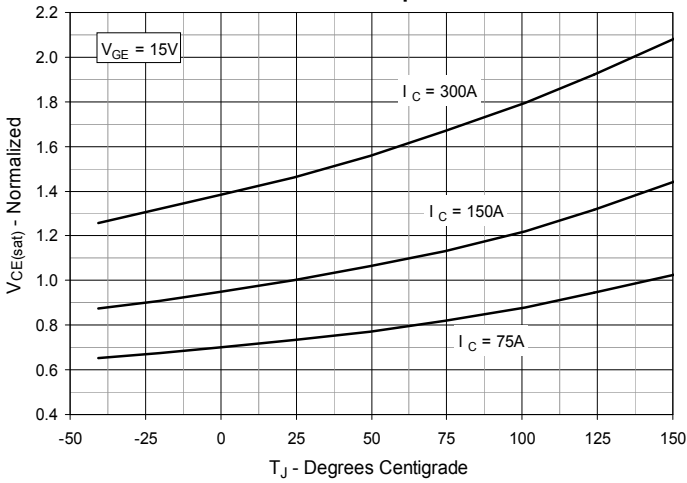

**Fig. 4. Collector-to-Emitter Voltage vs. Gate-to-Emitter Voltage**

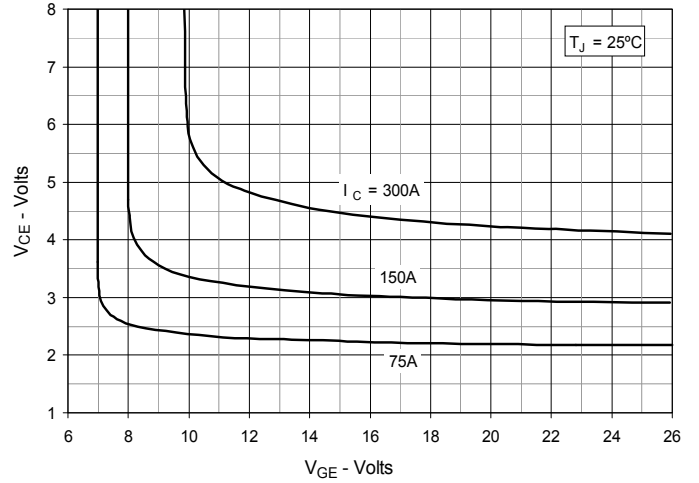

**Fig. 5. Input Admittance**

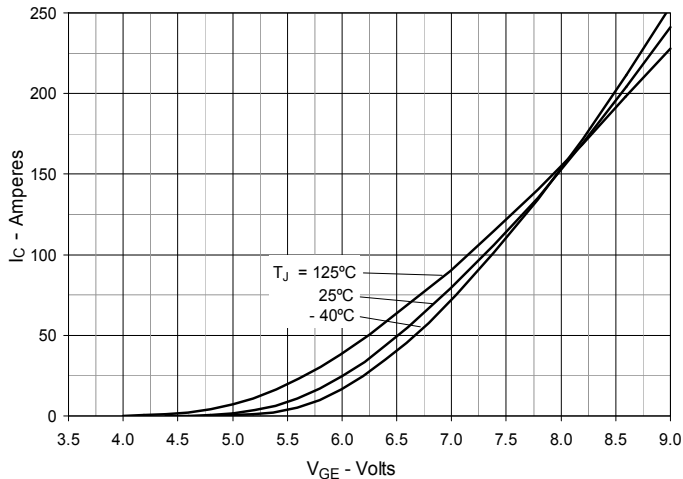

**Fig. 6. Transconductance**

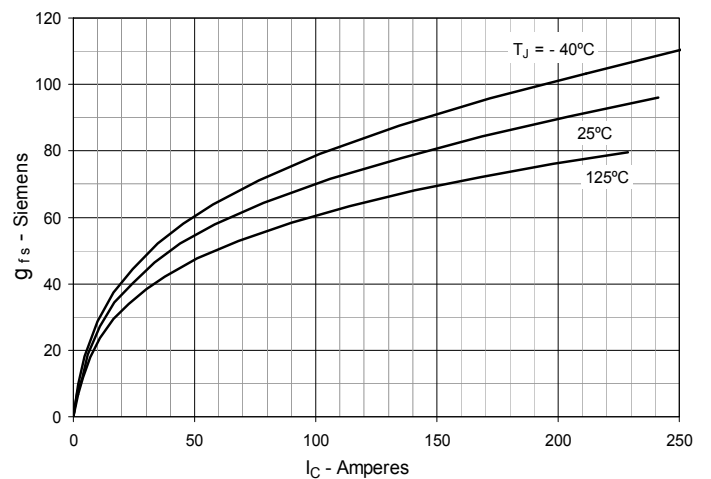

**Fig. 7. Gate Charge**

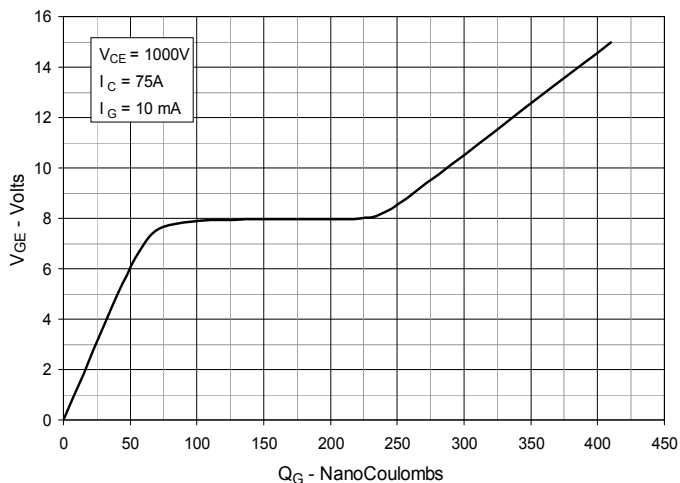

**Fig. 8. Capacitance**

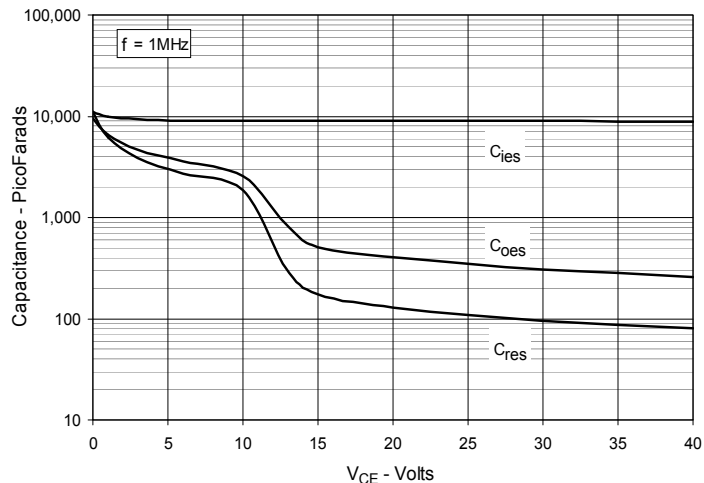

**Fig. 9. Reverse-Bias Safe Operating Area**

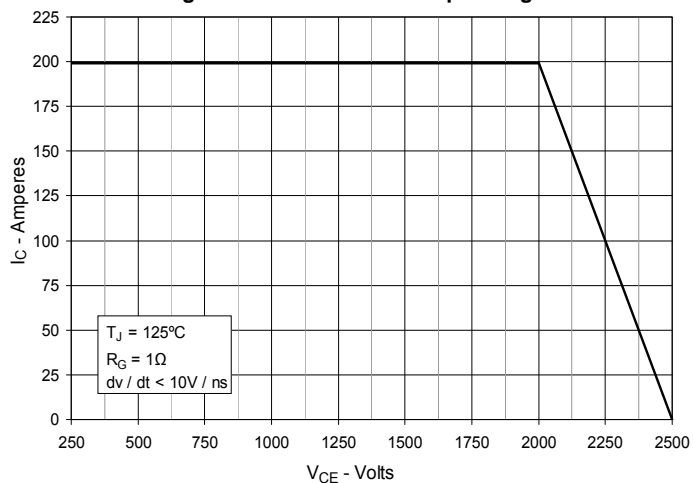

**Fig. 10. Maximum Transient Thermal Impedance**

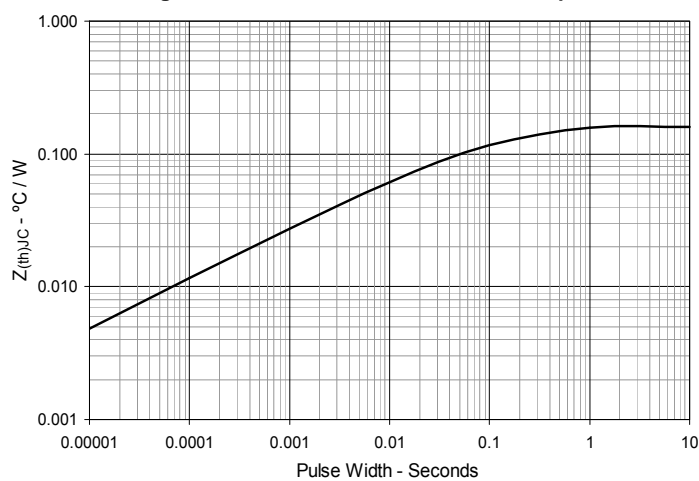

**Fig. 11. Resistive Turn-on Rise Time vs. Junction Temperature**

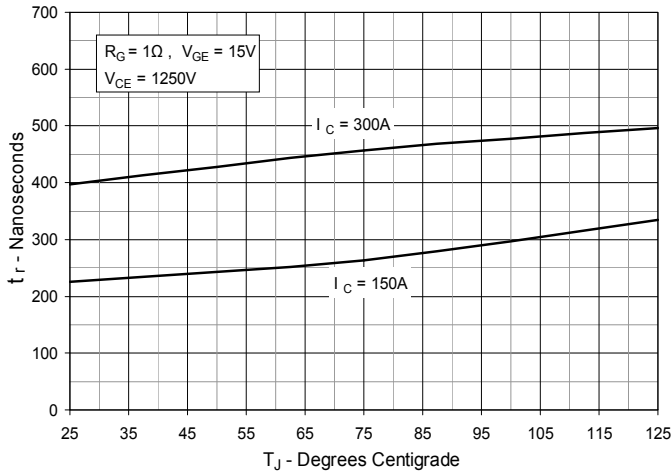

**Fig. 12. Resistive Turn-on Rise Time vs. Collector Current**

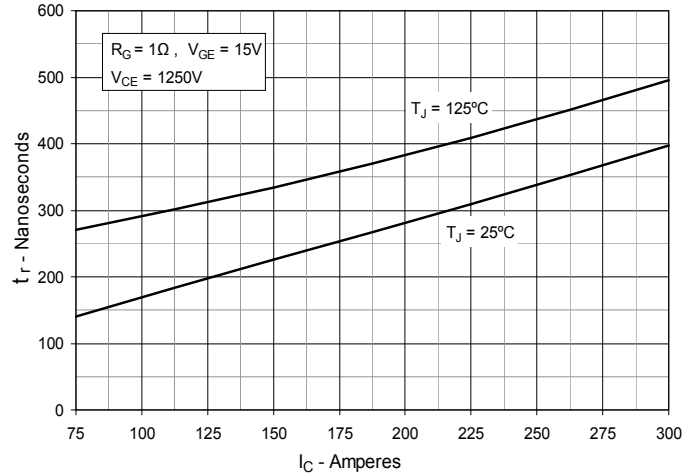

**Fig. 13. Resistive Turn-on Switching Times vs. Gate Resistance**

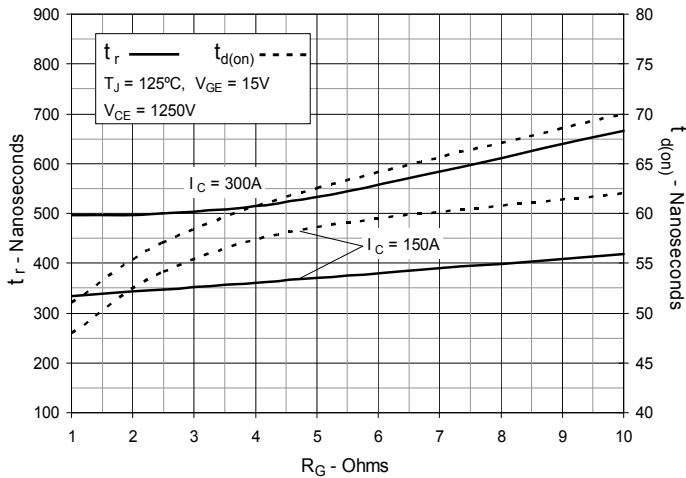

**Fig. 14. Resistive Turn-off Switching Times vs. Junction Temperature**

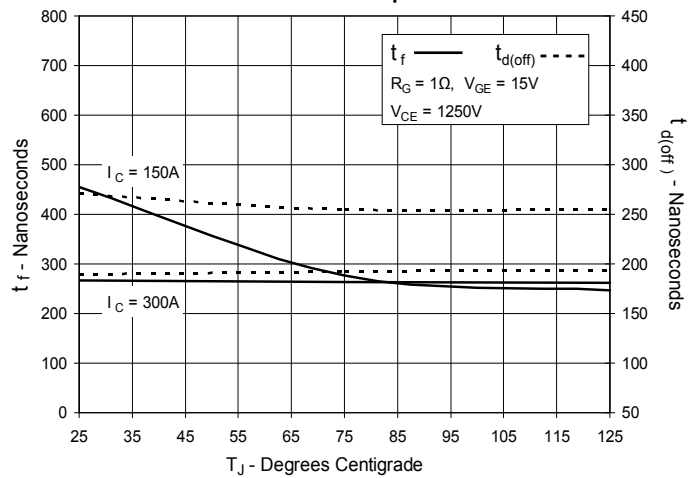

**Fig. 15. Resistive Turn-off Switching Times vs. Collector Current**

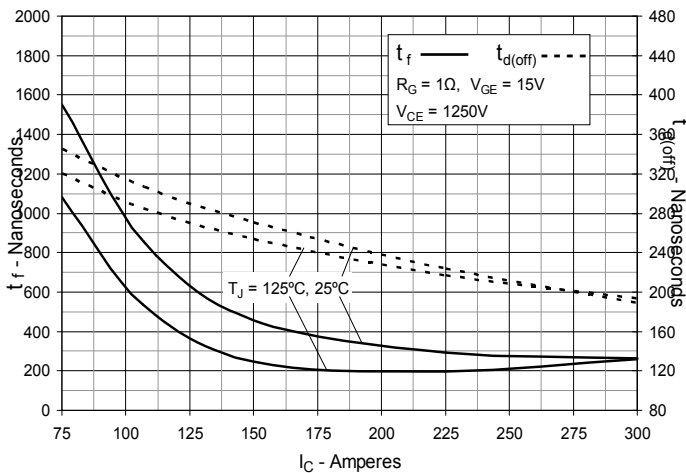

**Fig. 16. Resistive Turn-off Switching Times vs. Gate Resistance**

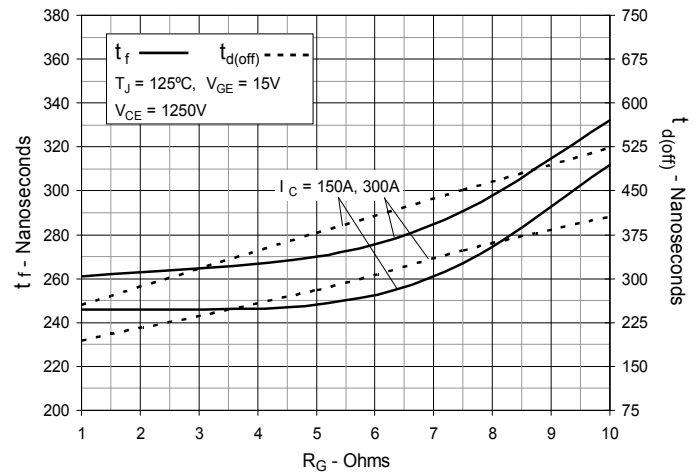



---

Disclaimer Notice - Information furnished is believed to be accurate and reliable. However, users should independently evaluate the suitability of and test each product selected for their own applications. Littelfuse products are not designed for, and may not be used in, all applications. Read complete Disclaimer Notice at [www.littelfuse.com/disclaimer-electronics](http://www.littelfuse.com/disclaimer-electronics).