

High Voltage IGBT

IXGH 25N160
IXGT 25N160

$V_{CES} = 1600 \text{ V}$
 $I_{C25} = 75 \text{ A}$
 $V_{CE(sat)} = 2.5 \text{ V}$

For Capacitor Discharge Applications

Preliminary Data Sheet

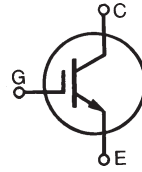

Symbol	Test Conditions	Maximum Ratings	
V_{CES}	$T_J = 25^\circ\text{C to } 150^\circ\text{C}$	1600	V
V_{CGR}	$T_J = 25^\circ\text{C to } 150^\circ\text{C}; R_{GE} = 1 \text{ M}\Omega$	1600	V
V_{GES}	Continuous	± 20	V
V_{GEM}	Transient	± 30	V
I_{C25}	$T_C = 25^\circ\text{C}$	75	A
I_{C110}	$T_C = 110^\circ\text{C}$	25	A
I_{CM}	$T_C = 25^\circ\text{C}, V_{GE} = 20 \text{ V}, 1 \text{ ms}$	200	A
SSOA (RBSOA)	$V_{GE} = 15 \text{ V}, T_{VJ} = 125^\circ\text{C}, R_G = 20 \Omega$ Clamped inductive load	$I_{CM} = 100$ @ $0.8 V_{CES}$	A
P_C	$T_C = 25^\circ\text{C}$	300	W
T_J		-55 ... +150	$^\circ\text{C}$
T_{JM}		150	$^\circ\text{C}$
T_{stg}		-55 ... +150	$^\circ\text{C}$
Maximum Lead temperature for soldering 1.6 mm (0.062 in.) from case for 10 s		300	$^\circ\text{C}$
Maximum Tab temperature for soldering SMD devices for 10 s		260	$^\circ\text{C}$
M_d	Mounting torque (TO-247)	1.13/10	Nm/lb-in
Weight		TO-247	6 g
		TO-268	4 g

TO-247 (IXGH)

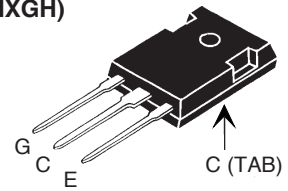

TO-268 (IXGT)

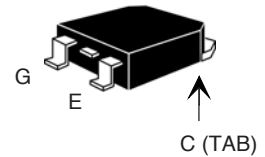

G = Gate, C = Collector,
E = Emitter, TAB = Collector

Features

- High peak current capability
- Low saturation voltage
- MOS Gate turn-on -drive simplicity
- Rugged NPT structure
- International standard packages
 - JEDEC TO-268 and
 - JEDEC TO-247 AD
- Molding epoxies meet UL 94 V-0 flammability classification

Applications

- Capacitor discharge
- Pulser circuits

Advantages

- High power density
- Suitable for surface mounting
- Easy to mount with 1 screw, (isolated mounting screw hole)

Symbol	Test Conditions	Characteristic Values ($T_J = 25^\circ\text{C}$ unless otherwise specified)		
		min.	typ.	max.
BV_{CES}	$I_C = 250 \mu\text{A}, V_{GE} = 0 \text{ V}$	1600		V
$V_{GE(th)}$	$I_C = 250 \mu\text{A}, V_{CE} = V_{GE}$	3.0		V
I_{CES}	$V_{CE} = 0.8 \cdot V_{CES}$ $V_{GE} = 0 \text{ V}$ $T_J = 125^\circ\text{C}$			50 μA 1 mA
I_{GES}	$V_{CE} = 0 \text{ V}, V_{GE} = \pm 30 \text{ V}$			$\pm 100 \text{ nA}$
$V_{CE(sat)}$	$I_C = I_{C110}, V_{GE} = 15 \text{ V}$			2.5 V
	$I_C = 100 \text{ A}, V_{GE} = 20 \text{ V}$			4.7 V

Symbol	Test Conditions	Characteristic Values ($T_J = 25^\circ\text{C}$ unless otherwise specified)		
		min.	typ.	max.
g_{fs}	$I_C = 50\text{ A}$; $V_{CE} = 10\text{ V}$, Note 1	14	21	S
$I_{C(ON)}$	$V_{GE} = 15\text{ V}$, $V_{CE} = 10\text{ V}$, Note 1		200	A
C_{ies}	$V_{CE} = 25\text{ V}$, $V_{GE} = 0\text{ V}$, $f = 1\text{ MHz}$		2090	pF
C_{oes}			94	pF
C_{res}			34	pF
Q_g	$I_C = 50\text{ A}$, $V_{GE} = 15\text{ V}$, $V_{CE} = 0.5 V_{CES}$		84	nC
Q_{ge}			15	nC
Q_{gc}			37	nC
$t_{d(on)}$	Resistive load		47	ns
t_{ri}	$I_C = 100\text{ A}$, $V_{GE} = 15\text{ V}$, Note 1		236	ns
$t_{d(off)}$	$V_{CE} = 1200\text{ V}$, $R_G = 10\ \Omega$		86	ns
t_{fi}			440	ns
R_{thJC}				0.42 K/W
R_{thCK}	(TO-247)		0.25	K/W

Notes: 1. Pulse test, $t < 300\ \mu\text{s}$, duty cycle $< 2\%$

TO-268: Minimum Recommended Footprint

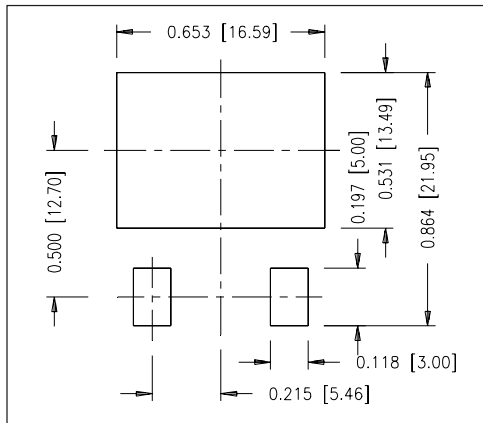

PRELIMINARY TECHNICAL INFORMATION

The product presented herein is under development. The Technical Specifications offered are derived from data gathered during objective characterizations of preliminary engineering lots; but also may yet contain some information supplied during a subjective pre-production design evaluation. IXYS reserves the right to change limits, test conditions, and dimensions without notice.

IXYS reserves the right to change limits, test conditions, and dimensions.

IXYS MOSFETs and IGBTs are covered by 4,835,592 4,931,844 5,049,961 5,237,481 6,162,665 6,404,065 B1 6,683,344 6,727,585
one or more of the following U.S. patents: 4,850,072 5,017,508 5,063,307 5,381,025 6,259,123 B1 6,534,343 6,710,405 B2 6,759,692
4,881,106 5,034,796 5,187,117 5,486,715 6,306,728 B1 6,583,505 6,710,463 6771478 B2

TO-247 AD Outline

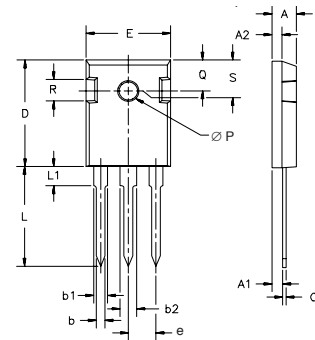

Dim.	Millimeter		Inches	
	Min.	Max.	Min.	Max.
A	4.7	5.3	.185	.209
A ₁	2.2	2.54	.087	.102
A ₂	2.2	2.6	.059	.098
b	1.0	1.4	.040	.055
b ₁	1.65	2.13	.065	.084
b ₂	2.87	3.12	.113	.123
C	.4	.8	.016	.031
D	20.80	21.46	.819	.845
E	15.75	16.26	.610	.640
e	5.20	5.72	0.205	0.225
L	19.81	20.32	.780	.800
L1		4.50		.177
ØP	3.55	3.65	.140	.144
Q	5.89	6.40	0.232	0.252
R	4.32	5.49	.170	.216
S			242 BSC	

TO-268 Outline

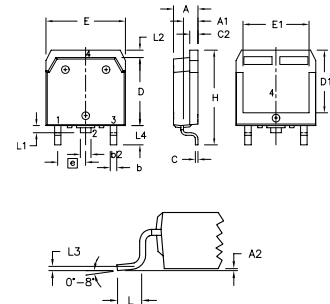

Dim.	Millimeter		Inches	
	Min.	Max.	Min.	Max.
A	4.9	5.1	.193	.201
A ₁	2.7	2.9	.106	.114
A ₂	.02	.25	.001	.010
b	1.15	1.45	.045	.057
b ₂	1.9	2.1	.75	.83
C	.4	.65	.016	.026
D	13.80	14.00	.543	.551
E	15.85	16.05	.624	.632
E ₁	13.3	13.6	.524	.535
e	5.45 BSC		.215 BSC	
H	18.70	19.10	.736	.752
L	2.40	2.70	.094	.106
L1	1.20	1.40	.047	.055
L2	1.00	1.15	.039	.045
L3	0.25 BSC		.010 BSC	
L4	3.80	4.10	.150	.161

Fig. 1. Output Characteristics @ 25°C

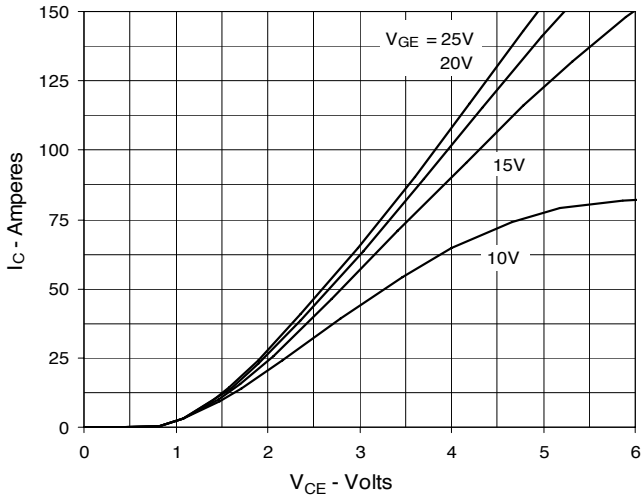

Fig. 2. Extended Output Characteristics @ 25°C

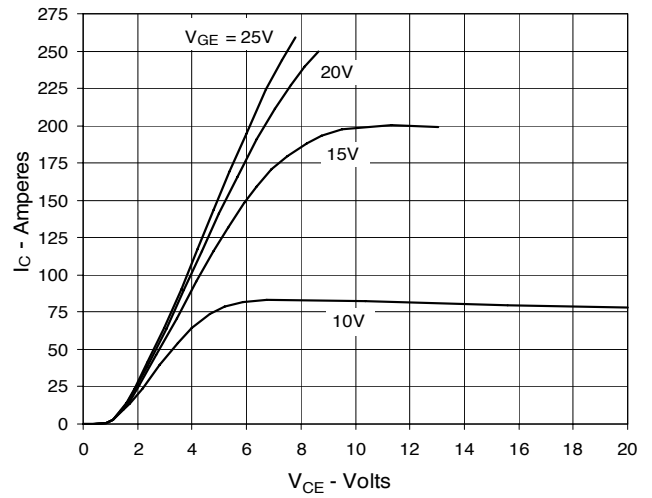

Fig. 3. Output Characteristics @ 125°C

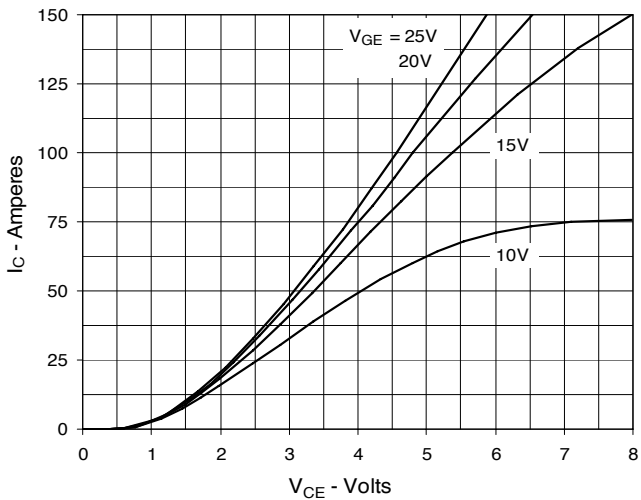

Fig. 4. Dependence of $V_{CE(sat)}$ on Junction Temperature

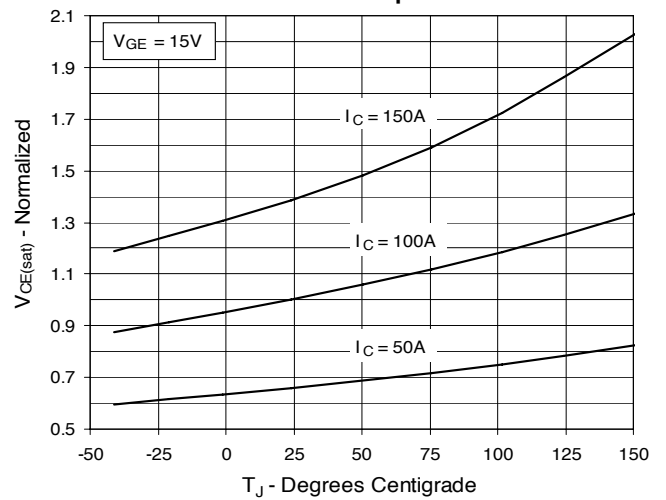

Fig. 5. Collector-to-Emitter Voltage vs. Gate-to-Emitter Voltage

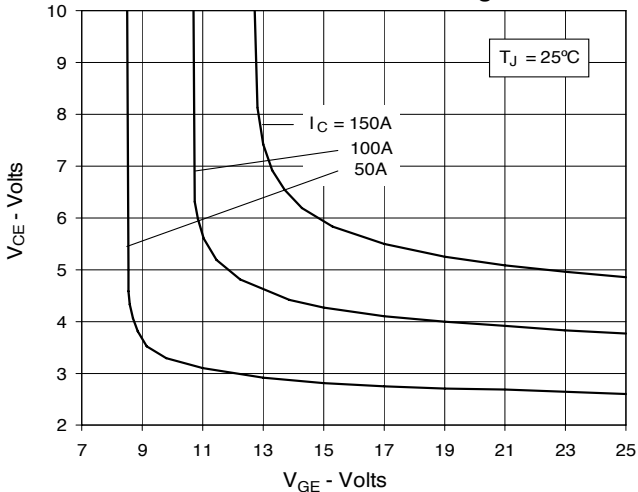

Fig. 6. Input Admittance

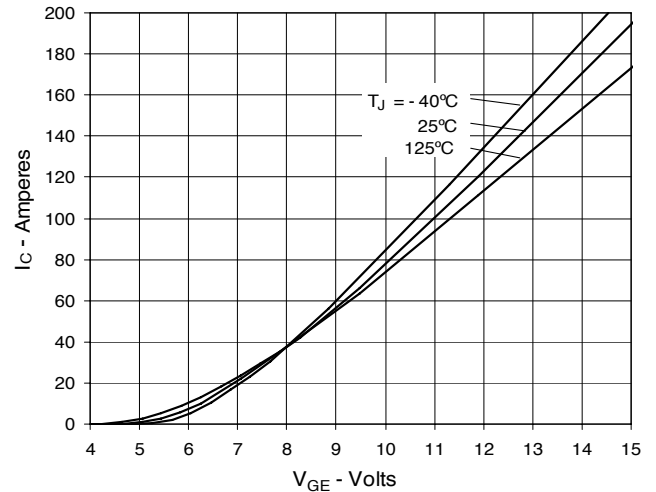

Fig. 7. Transconductance

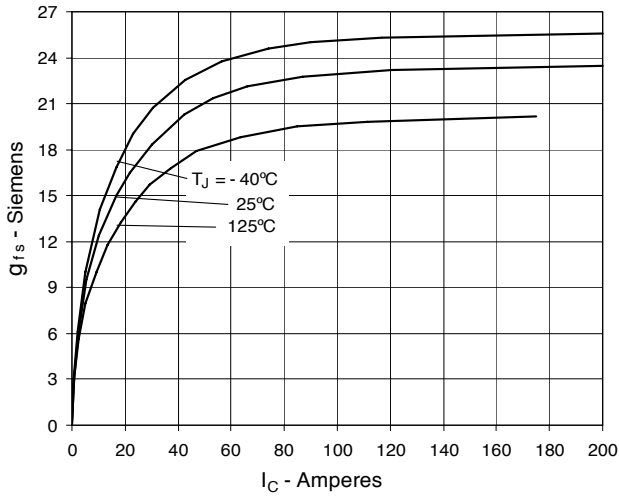

Fig. 8. Resistive Turn-On Rise Time vs. Junction Temperature

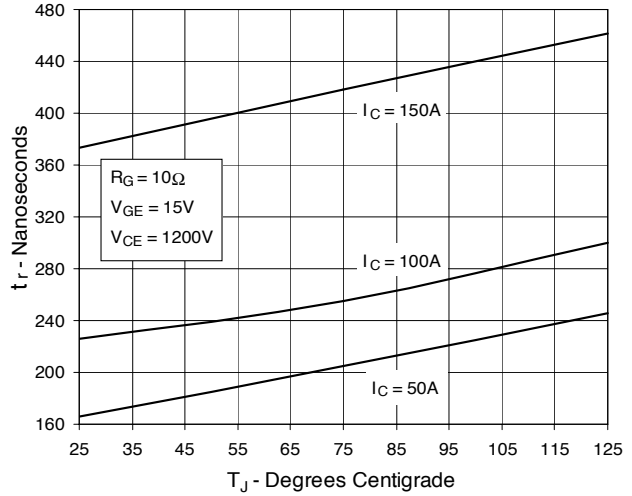

Fig. 9. Resistive Turn-On Rise Time vs. Collector Current

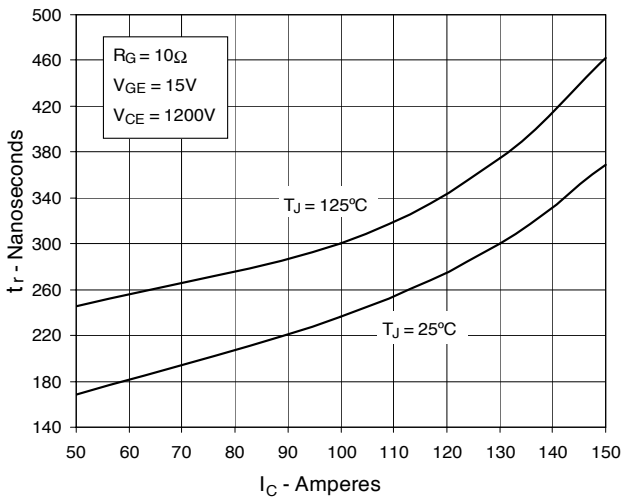

Fig. 10. Resistive Turn-On Switching Times vs. Gate Resistance

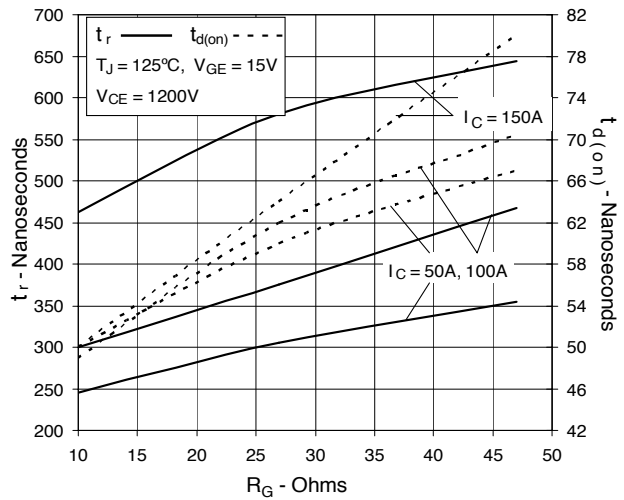

Fig. 11. Resistive Turn-Off Switching Times vs. Junction Temperature

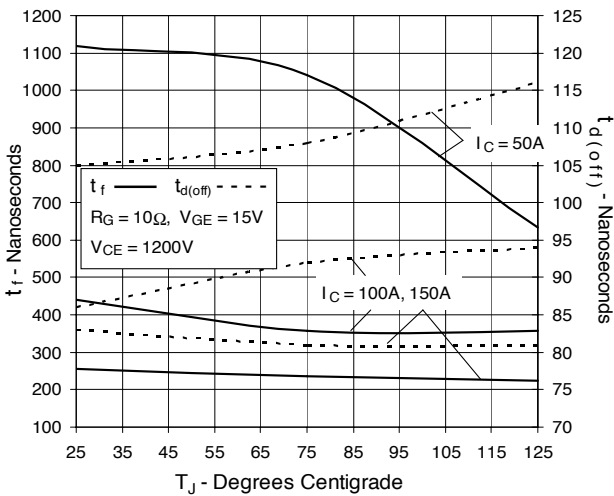

Fig. 12. Resistive Turn-Off Switching Times vs. Collector Current

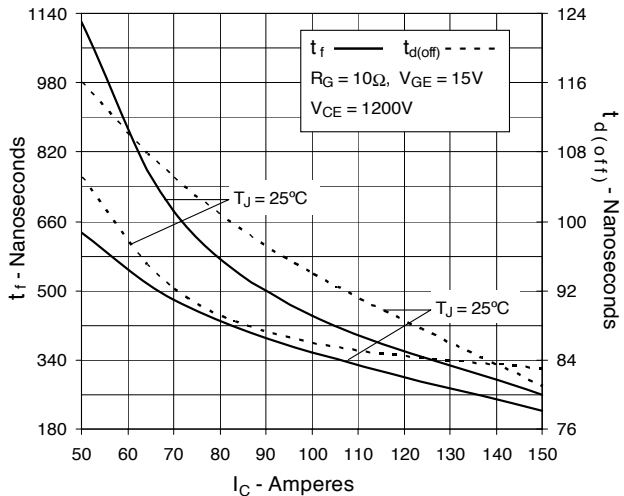

Fig. 13. Resistive Turn-Off Switching Times vs. Gate Resistance

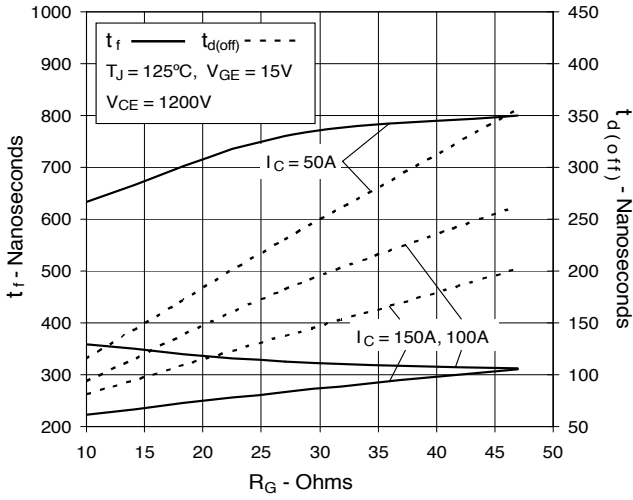

Fig. 14. Gate Charge

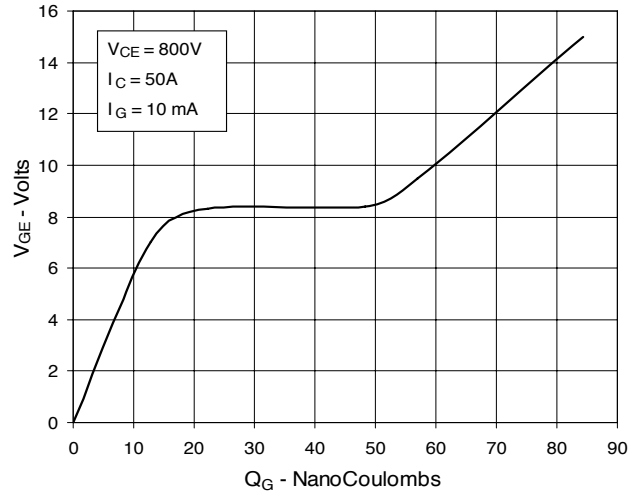

Fig. 15. Reverse-Bias Safe Operating Area

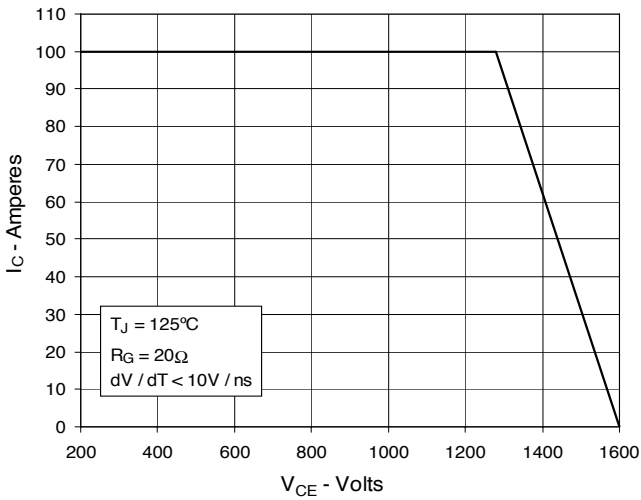

Fig. 16. Capacitance

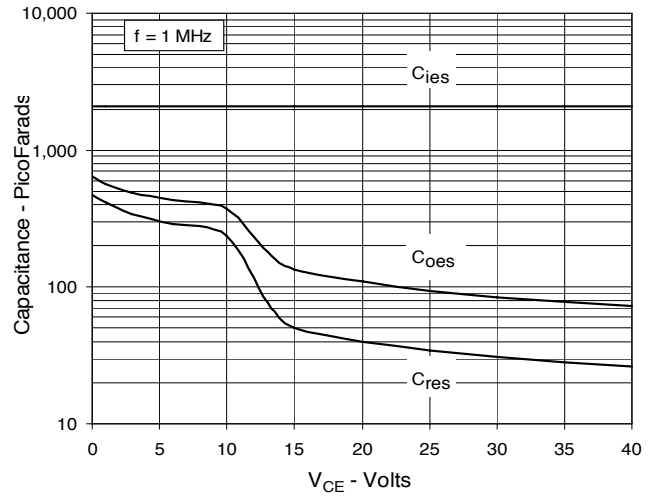
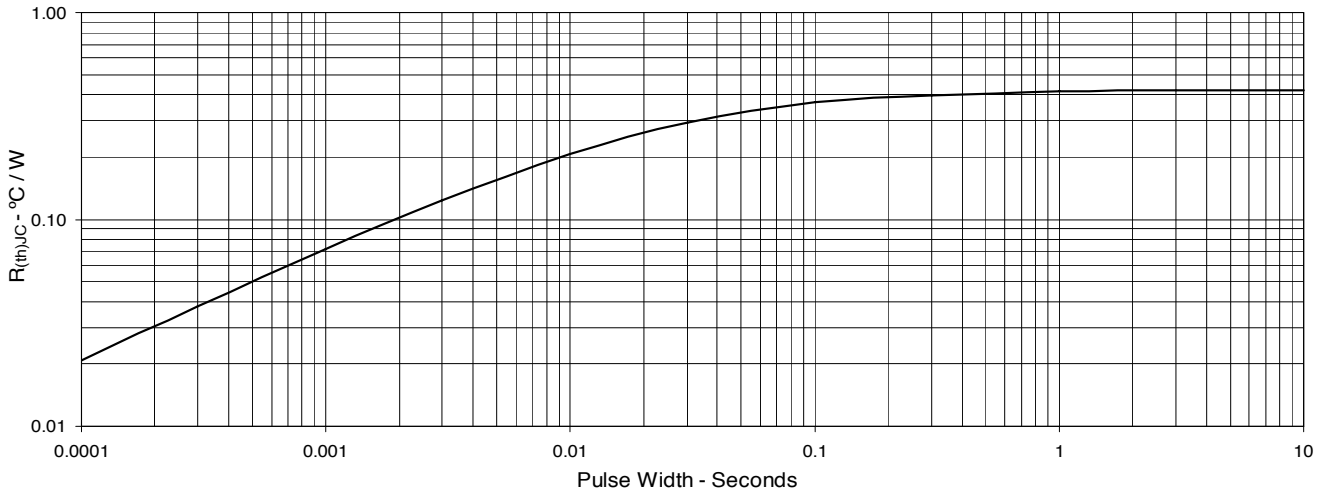

Fig. 17. Maximum Transient Thermal Resistance





Disclaimer Notice - Information furnished is believed to be accurate and reliable. However, users should independently evaluate the suitability of and test each product selected for their own applications. Littelfuse products are not designed for, and may not be used in, all applications. Read complete Disclaimer Notice at www.littelfuse.com/disclaimer-electronics.