

# IGBT with optional Diode

High Speed,  
Low Saturation Voltage

$$V_{CES} = 600 \text{ V}$$

$$I_{C25} = 38 \text{ A}$$

$$V_{CE(sat) \text{ typ}} = 2.2 \text{ V}$$

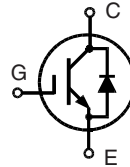
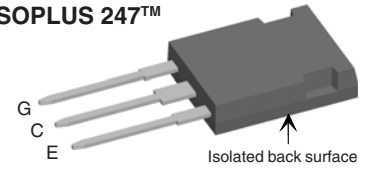
**ISOPLUS 247™**

G = Gate, E = Emitter  
C = Collector, TAB = Collector

Symbol	Conditions	Maximum Ratings	
$V_{CES}$	$T_J = 25^\circ\text{C to } 150^\circ\text{C}$	600	V
$V_{CGR}$	$T_J = 25^\circ\text{C to } 150^\circ\text{C}; R_{GE} = 20 \text{ k}\Omega$	600	V
$V_{GES}$	Continuous	$\pm 20$	V
$V_{GEM}$	Transient	$\pm 30$	V
$I_{C25}$	$T_C = 25^\circ\text{C}$	38	A
$I_{C90}$	$T_C = 90^\circ\text{C}$	24	A
$I_{CM}$	$T_C = 90^\circ\text{C}, t_p = 1 \text{ ms}$	48	A
<b>RBSOA</b>	$V_{GE} = \pm 15 \text{ V}, T_J = 125^\circ\text{C}, R_G = 10 \Omega$ Clamped inductive load, $L = 30 \mu\text{H}$	$I_{CM} = 110$ $V_{CEK} < V_{CES}$	A
<b><math>t_{SC}</math> (SCSOA)</b>	$V_{GE} = \pm 15 \text{ V}, V_{CE} = 600 \text{ V}, T_J = 125^\circ\text{C}$ $R_G = 10 \Omega$ , non repetitive	10	$\mu\text{s}$
<b><math>P_C</math></b>	$T_C = 25^\circ\text{C}$	IGBT	125 W
		Diode	50 W
<b><math>T_J</math></b>		-55 ... +150	$^\circ\text{C}$
<b><math>T_{stg}</math></b>		-55 ... +150	$^\circ\text{C}$
<b><math>V_{ISOL}</math></b>	50/60 Hz RMS; $I_{ISOL} \leq 1 \text{ mA}$	2500	V~
<b><math>F_C</math></b>	mounting force with clip	20...120	N
<b>Weight</b>	typical	6	g

**Features**

- NPT IGBT technology
- low switching losses
- low tail current
- no latch up
- short circuit capability
- positive temperature coefficient for easy paralleling
- MOS input, voltage controlled
- optional ultra fast diode
- Epoxy meets UL 94V-0
- Isolated and UL registered E153432

**Advantages**

- DCB Isolated mounting tab
- Meets TO-247AD package Outline
- Package for clip or spring mounting
- Space savings
- High power density

**Typical Applications**

- AC motor speed control
- DC servo and robot drives
- DC choppers
- Uninterruptible power supplies (UPS)
- Switch-mode and resonant-mode power supplies

Symbol	Conditions	Characteristic Values ( $T_J = 25^\circ\text{C}$ , unless otherwise specified)		
		min.	typ.	max.
$V_{(BR)CES}$	$V_{GE} = 0 \text{ V}$	600		V
$V_{GE(th)}$	$I_C = 0.7 \text{ mA}, V_{CE} = V_{GE}$	3		5 V
$I_{CES}$	$V_{CE} = V_{CES}$ $T_J = 25^\circ\text{C}$ $T_J = 125^\circ\text{C}$		1	0.1 mA mA
$I_{GES}$	$V_{CE} = 0 \text{ V}, V_{GE} = \pm 20 \text{ V}$			$\pm 500 \text{ nA}$
$V_{CE(sat)}$	$I_C = 35 \text{ A}, V_{GE} = 15 \text{ V}$		2.2	2.7 V

Symbol	Conditions	Characteristic Values ( $T_J = 25^\circ\text{C}$ , unless otherwise specified)		
		min.	typ.	max.
$C_{ies}$	$V_{CE} = 25\text{ V}, V_{GE} = 0\text{ V}, f = 1\text{ MHz}$		1600	pF
$C_{oes}$			150	pF
$C_{res}$			90	pF
$Q_g$	$I_C = 35\text{ A}, V_{GE} = 15\text{ V}, V_{CE} = 480\text{ V}$		140	nC
$t_{d(on)}$	<b>Inductive load, <math>T_J = 125^\circ\text{C}</math></b> $I_C = 35\text{ A}, V_{GE} = \pm 15\text{ V},$ $V_{CE} = 300\text{ V}, R_G = 10\ \Omega$		30	ns
$t_r$			45	ns
$t_{d(off)}$			320	ns
$t_f$			70	ns
$E_{on}$			1.6	mJ
$E_{off}$		0.8	mJ	
$R_{thJC}$	Package with heatsink compound			1 K/W
$R_{thCH}$			0.25	K/W

**Reverse Diode (FRED) [D1 version only]**

Symbol	Conditions	Characteristic Values ( $T_J = 25^\circ\text{C}$ , unless otherwise specified)		
		min.	typ.	max.
$V_F$	$I_F = 35\text{ A}, V_{GE} = 0\text{ V}$		2.1	V
	$I_F = 35\text{ A}, V_{GE} = 0\text{ V}, T_J = 125^\circ\text{C}$		1.6	V
$I_F$	$T_C = 25^\circ\text{C}$			35 A
	$T_C = 90^\circ\text{C}$			18 A
$I_{RM}$	$I_F = 15\text{ A}, -di_F/dt = 400\text{ A}/\mu\text{s}, V_R = 300\text{ V}$		13	A
$t_{rr}$	$V_{GE} = 0\text{ V}, T_J = 125^\circ\text{C}$		90	ns
$t_{rr}$	$I_F = 1\text{ A}, -di_F/dt = 100\text{ A}/\mu\text{s}, V_R = 30\text{ V}, V_{GE} = 0\text{ V}$		40	ns
$R_{thJC}$				2.3 K/W

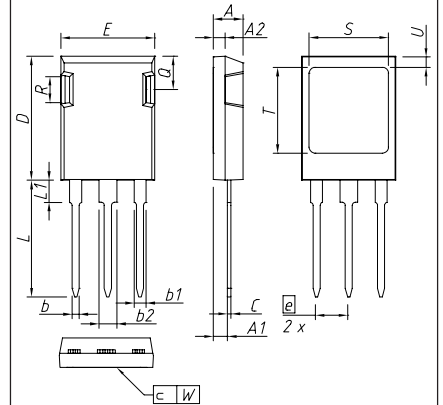
**ISOPLUS247™ OUTLINE**

DIM.	MILLIMETER		INCHES	
	MIN	MAX	MIN	MAX
A	4,83	5,21	0,190	0,205
A1	2,29	2,54	0,090	0,100
A2	1,91	2,16	0,075	0,085
b	1,14	1,40	0,045	0,055
b1	1,91	2,15	0,075	0,085
b2	2,92	3,20	0,115	0,126
C	0,61	0,83	0,024	0,033
D	20,80	21,34	0,819	0,840
E	15,75	16,13	0,620	0,635
e	5,45 BSC		0,215 BSC	
L	19,81	20,60	0,780	0,811
L1	3,81	4,38	0,150	0,172
Q	5,59	6,20	0,220	0,244
R	4,32	4,85	0,170	0,191
S	13,21	13,72	0,520	0,540
T	15,75	16,26	0,620	0,640
U	1,65	2,03	0,065	0,080
W	-	0,10	-	0,004

The convex bow of substrate is typ. < 0.04 mm over plastic surface level of device bottom side  
This drawing will meet all dimensions requirement of JEDEC outline TO-247 AD except screw hole and except Lmax.

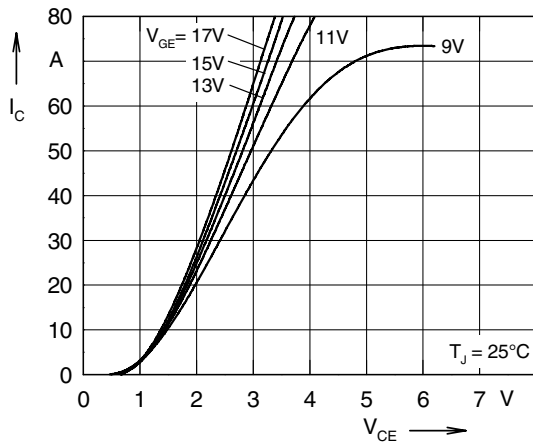

Fig. 1 Typ. output characteristics

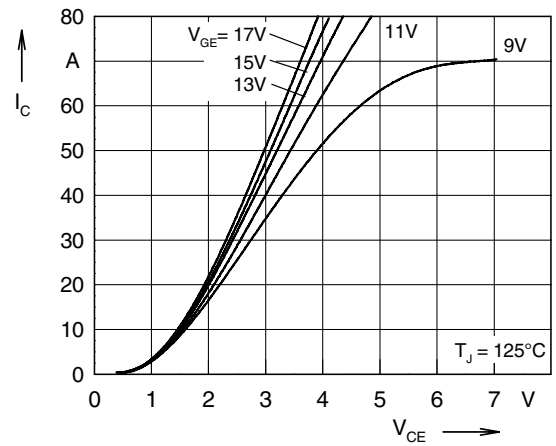

Fig. 2 Typ. output characteristics

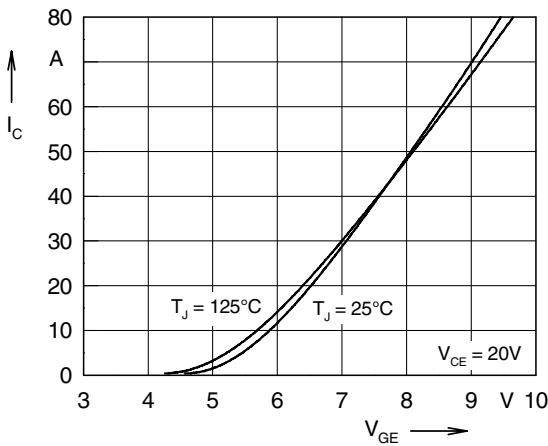

Fig. 3 Typ. transfer characteristics

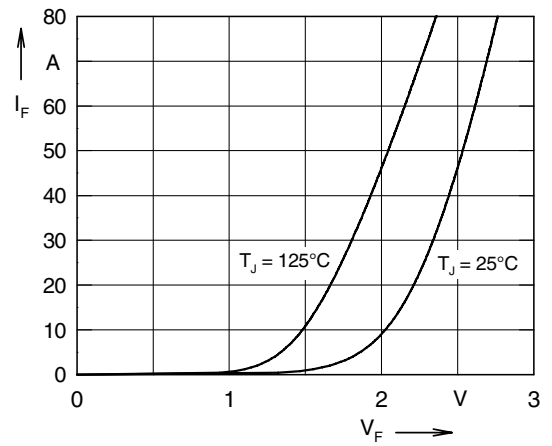

Fig. 4 Typ. forward characteristics of free wheeling diode

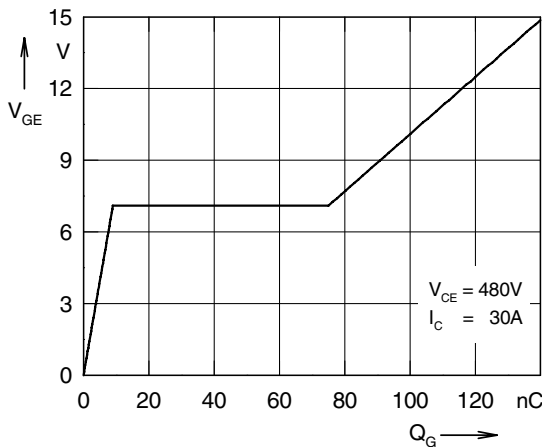

Fig. 5 Typ. turn on gate charge

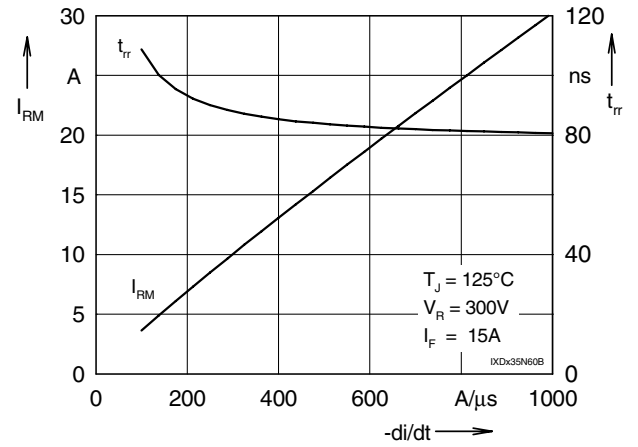

Fig. 6 Typ. turn off characteristics of free wheeling diode

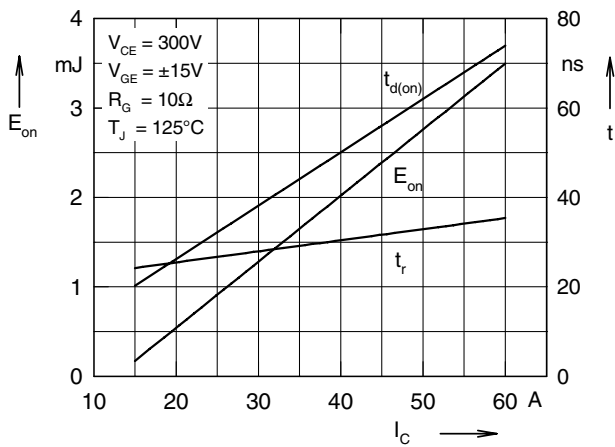

Fig. 7 Typ. turn on energy and switching times versus collector current

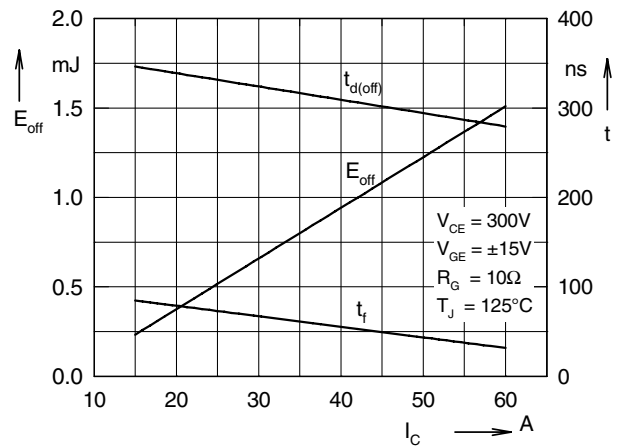

Fig. 8 Typ. turn off energy and switching times versus collector current

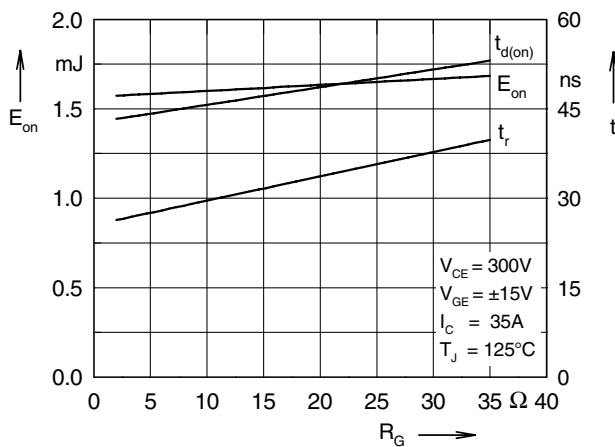

Fig. 9 Typ. turn on energy and switching times versus gate resistor

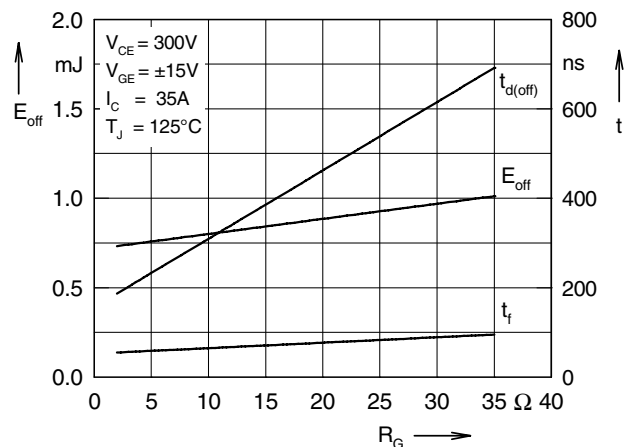

Fig.10 Typ. turn off energy and switching times versus gate resistor

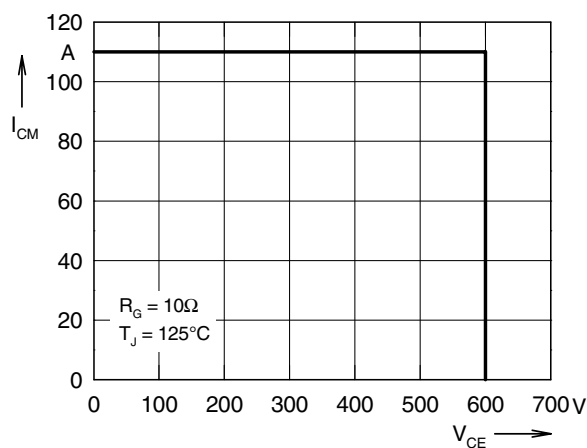

Fig. 11 Reverse biased safe operating area RBSOA

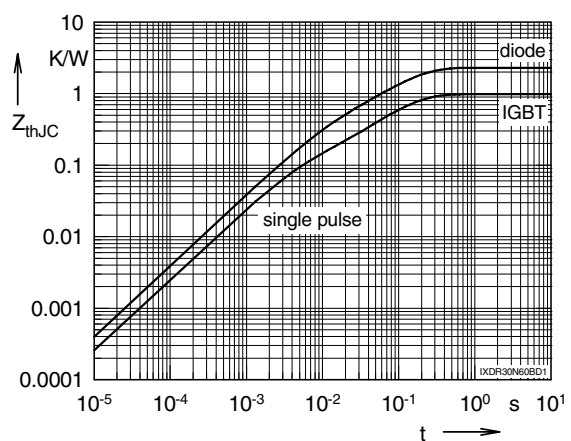

Fig. 12 Typ. transient thermal impedance



---

Disclaimer Notice - Information furnished is believed to be accurate and reliable. However, users should independently evaluate the suitability of and test each product selected for their own applications. Littelfuse products are not designed for, and may not be used in, all applications. Read complete Disclaimer Notice at [www.littelfuse.com/disclaimer-electronics](http://www.littelfuse.com/disclaimer-electronics).