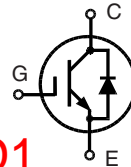
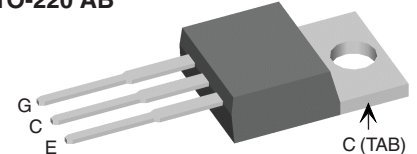

High Voltage IGBT with optional Diode

$V_{CES} = 600 \text{ V}$
 $I_{C25} = 32 \text{ A}$
 $V_{CE(sat) \text{ typ}} = 2.2 \text{ V}$

High Speed,
Low Saturation Voltage

Replacements:
IXYP15N65C3D1 / IXXP12N65B4D1

TO-220 AB

G = Gate,
C = Collector ,

E = Emitter
TAB = Collector

Symbol	Conditions	Maximum Ratings	
V_{CES}	$T_J = 25^\circ\text{C to } 150^\circ\text{C}$	600	V
V_{CGR}	$T_J = 25^\circ\text{C to } 150^\circ\text{C}; R_{GE} = 20 \text{ k}\Omega$	600	V
V_{GES}	Continuous	± 20	V
V_{GEM}	Transient	± 30	V
I_{C25}	$T_C = 25^\circ\text{C}$	32	A
I_{C90}	$T_C = 90^\circ\text{C}$	20	A
I_{CM}	$T_C = 90^\circ\text{C}, t_p = 1 \text{ ms}$	40	A
RBSOA	$V_{GE} = \pm 15 \text{ V}, T_J = 125^\circ\text{C}, R_G = 22 \Omega$ Clamped inductive load, $L = 30 \mu\text{H}$	$I_{CM} = 60$ $V_{CEK} < V_{CES}$	A
t_{SC} (SCSOA)	$V_{GE} = \pm 15 \text{ V}, V_{CE} = 600 \text{ V}, T_J = 125^\circ\text{C}$ $R_G = 22 \Omega$, non repetitive	10	μs
P_C	$T_C = 25^\circ\text{C}$	IGBT	140 W
		Diode	50 W
T_J		-55 ... +150	$^\circ\text{C}$
T_{stg}		-40 ... +150	$^\circ\text{C}$
	Maximum lead temperature for soldering 1.6 mm (0.062 in.) from case for 10 s	300	$^\circ\text{C}$
M_d	Mounting torque	0.4 - 0.6	Nm
Weight		2	g

Features

- NPT IGBT technology
- low switching losses
- low tail current
- no latch up
- short circuit capability
- positive temperature coefficient for easy paralleling
- MOS input, voltage controlled
- optional ultra fast diode
- International standard package

Advantages

- Space savings
- High power density

Typical Applications

- AC motor speed control
- DC servo and robot drives
- DC choppers
- Uninterruptible power supplies (UPS)
- Switch-mode and resonant-mode power supplies

Symbol	Conditions	Characteristic Values ($T_J = 25^\circ\text{C}$, unless otherwise specified)		
		min.	typ.	max.
$V_{(BR)CES}$	$V_{GE} = 0 \text{ V}$	600		V
$V_{GE(th)}$	$I_C = 0.4 \text{ mA}, V_{CE} = V_{GE}$	3		5 V
I_{CES}	$V_{CE} = V_{CES}$	$T_J = 25^\circ\text{C}$		0.1 mA
		$T_J = 125^\circ\text{C}$	0.7	mA
I_{GES}	$V_{CE} = 0 \text{ V}, V_{GE} = \pm 20 \text{ V}$			$\pm 500 \text{ nA}$
$V_{CE(sat)}$	$I_C = 20 \text{ A}, V_{GE} = 15 \text{ V}$		2.2	2.8 V

Symbol	Conditions	Characteristic Values		
		(T _J = 25°C, unless otherwise specified)		
		min.	typ.	max.
C _{ies}	V _{CE} = 25 V, V _{GE} = 0 V, f = 1 MHz		800	pF
C _{oes}			85	pF
C _{res}			50	pF
Q _g	I _C = 20 A, V _{GE} = 15 V, V _{CE} = 480 V		70	nC
t _{d(on)}	Inductive load, T _J = 125°C I _C = 20 A, V _{GE} = ±15 V, V _{CE} = 300 V, R _G = 22 Ω		25	ns
t _r			30	ns
t _{d(off)}			260	ns
t _f			55	ns
E _{on}			0.9	mJ
E _{off}			0.4	mJ
R _{thJC}	Package with heatsink compound	0.5		0.9 K/W
R _{thCH}				K/W
R _{thCK}	Package with heatsink compound		0.25	K/W

Reverse Diode (FRED) [D1 version only]		Characteristic Values		
		(T _J = 25°C, unless otherwise specified)		
Symbol	Conditions	min.	typ.	max.
V _F	I _F = 20 A, V _{GE} = 0 V	2.1	2.4	V
	I _F = 20 A, V _{GE} = 0 V, T _J = 125°C	1.6		V
I _F	T _C = 25°C			25 A
	T _C = 90°C			15 A
I _{RM}	I _F = 10 A, -di _F /dt = 400 A/μs, V _R = 300 V	11		A
t _{rr}	V _{GE} = 0 V, T _J = 125°C	80		ns
t _{rr}	I _F = 1 A, -di _F /dt = 100 A/μs, V _R = 30 V, V _{GE} = 0 V	40		ns
R _{thJC}				2.5 K/W

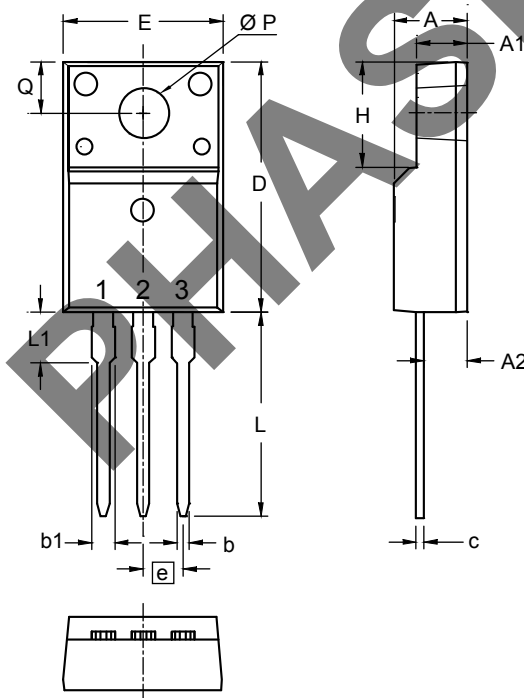

TO-220 AB Outline

Dim.	Millimeters		Inches	
	min	max	min	max
A	4.50	4.90	0.177	0.193
A1	2.34	2.74	0.092	0.108
A2	2.56	2.96	0.101	0.117
b	0.70	0.90	0.028	0.035
c	0.45	0.60	0.018	0.024
D	15.67	16.07	0.617	0.633
E	9.96	10.36	0.392	0.408
e	2.54 BSC		0.100 BSC	
H	6.48	6.88	0.255	0.271
L	12.68	13.28	0.499	0.523
L1	3.03	3.43	0.119	0.135
ØP	3.08	3.28	0.121	0.129
Q	3.20	3.40	0.126	0.134

IXYS reserves the right to change limits, test conditions and dimensions.

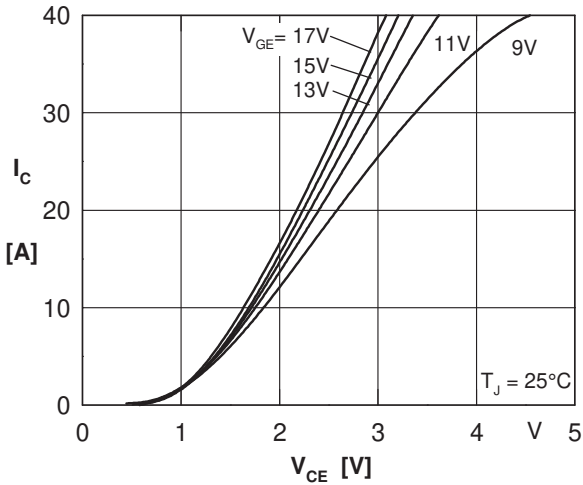

Fig. 1 Typ. output characteristics

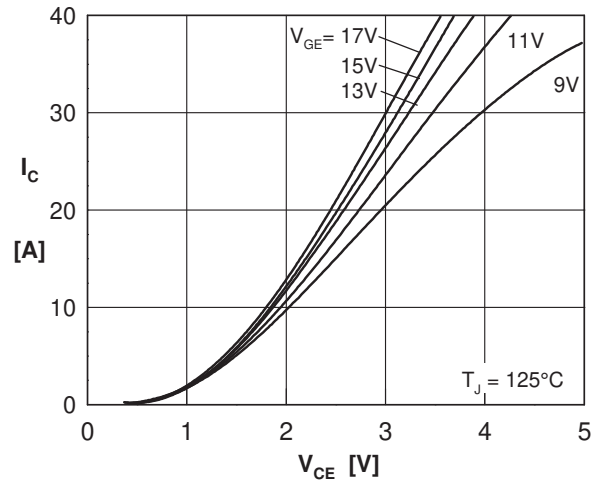

Fig. 2 Typ. output characteristics

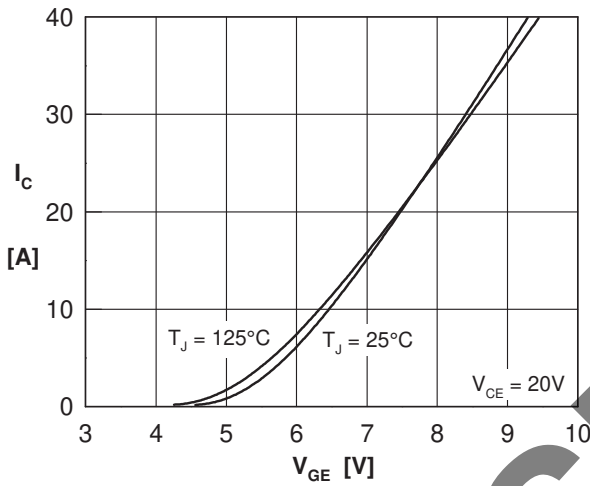

Fig. 3 Typ. transfer characteristics

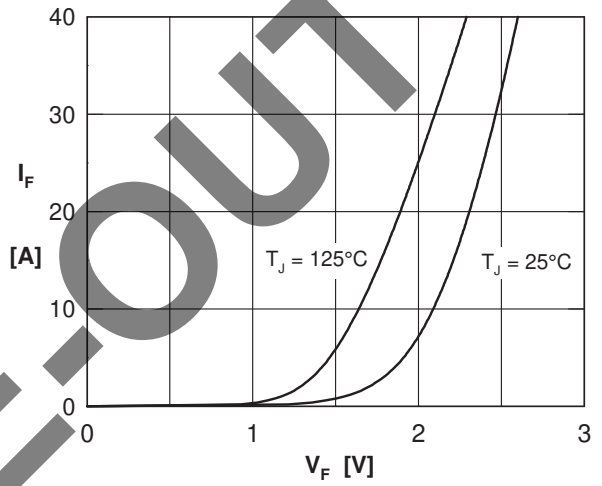

Fig. 4 Typ. forward characteristics of free wheeling diode

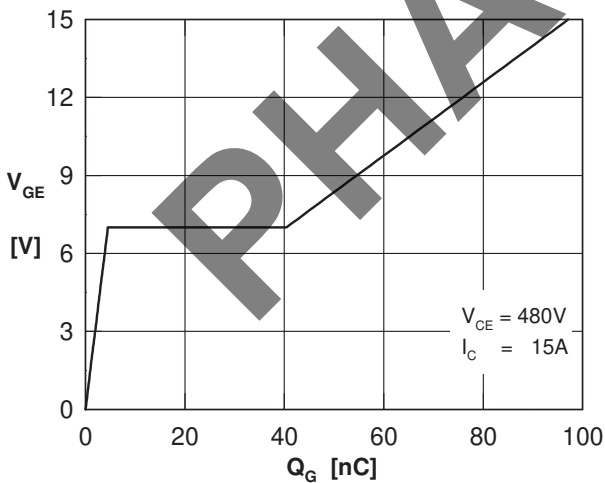

Fig. 5 Typ. turn on gate charge

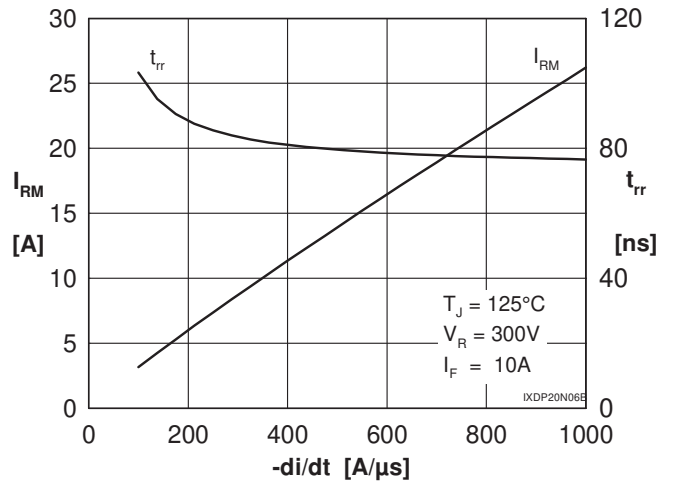

Fig. 6 Typ. turn off characteristics of free wheeling diode

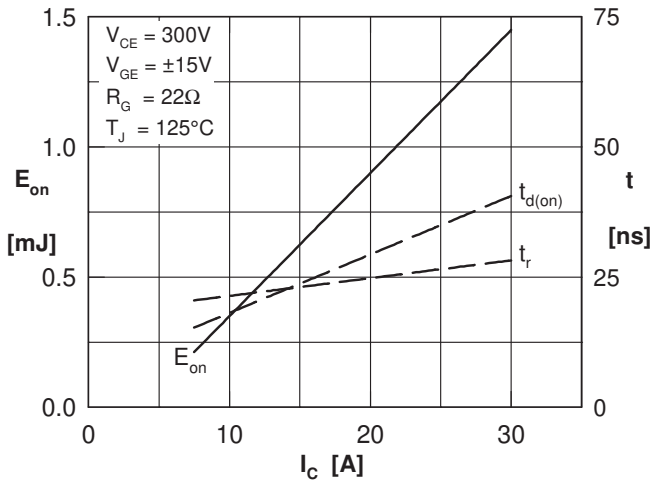

Fig. 7 Typ. turn on energy and switching times versus collector current

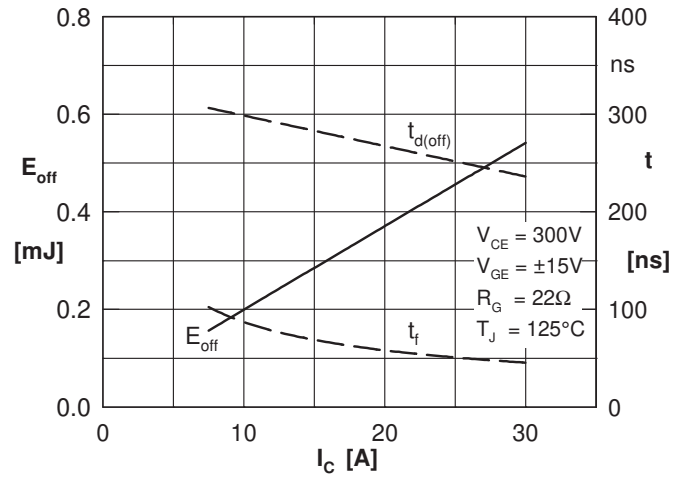

Fig. 8 Typ. turn off energy and switching times versus collector current

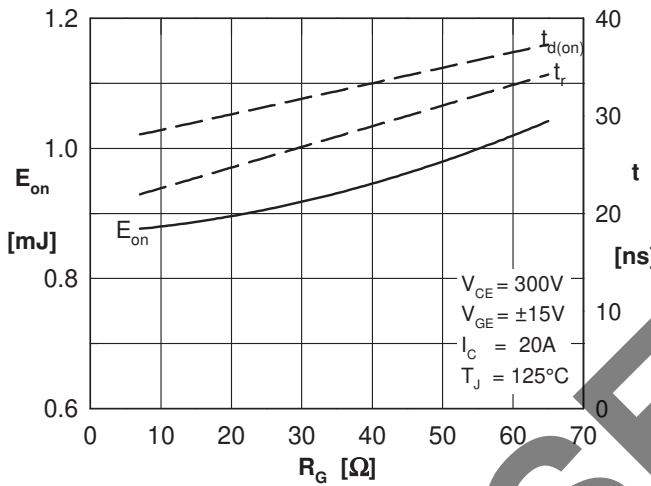

Fig. 9 Typ. turn on energy and switching times versus gate resistor

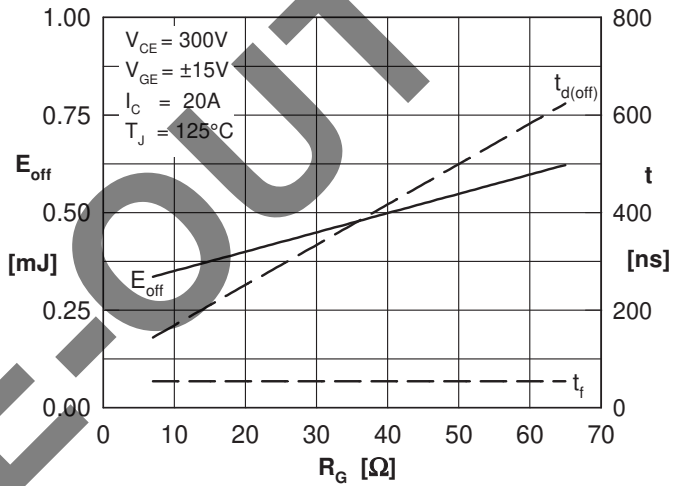

Fig. 10 Typ. turn off energy and switching times versus gate resistor

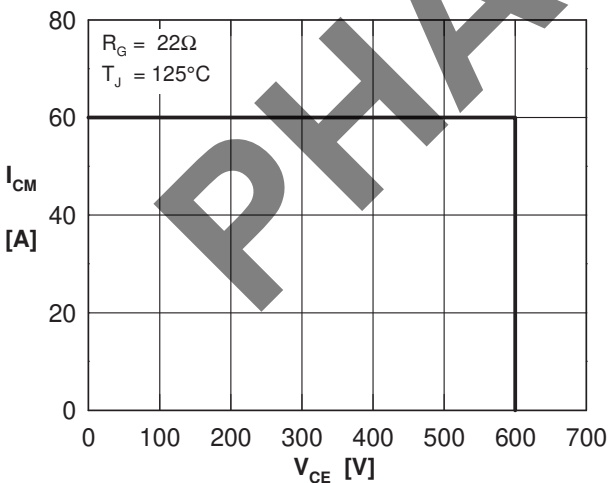

Fig. 5 Typ. turn on gate charge

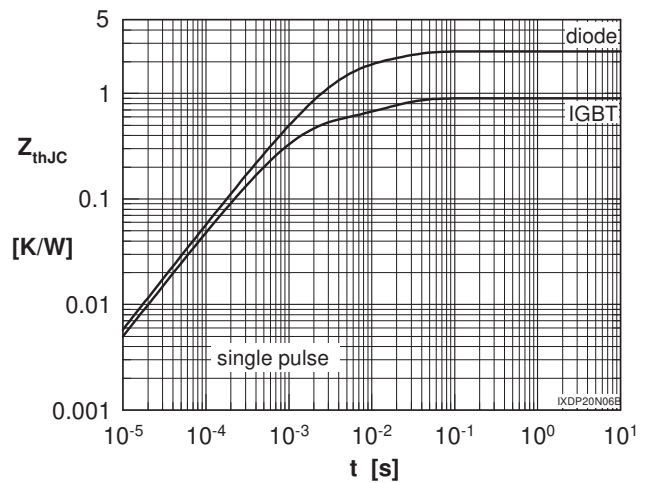

Fig. 6 Typ. turn off characteristics of free wheeling diode