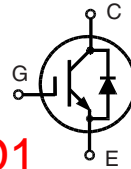
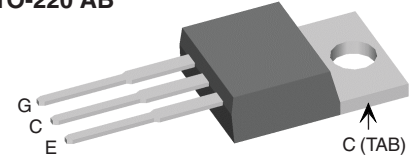

High Voltage IGBT with optional Diode

$V_{CES} = 600\text{ V}$
 $I_{C25} = 32\text{ A}$
 $V_{CE(sat) typ} = 2.2\text{ V}$

High Speed,
Low Saturation Voltage

Replacements:
IXYP15N65C3D1 / IXXP12N65B4D1

TO-220 AB

G = Gate,
C = Collector ,
E = Emitter
TAB = Collector

Symbol	Conditions	Maximum Ratings	
V_{CES}	$T_J = 25^\circ\text{C to } 150^\circ\text{C}$	600	V
V_{CGR}	$T_J = 25^\circ\text{C to } 150^\circ\text{C}; R_{GE} = 20\text{ k}\Omega$	600	V
V_{GES}	Continuous	± 20	V
V_{GEM}	Transient	± 30	V
I_{C25}	$T_C = 25^\circ\text{C}$	32	A
I_{C90}	$T_C = 90^\circ\text{C}$	20	A
I_{CM}	$T_C = 90^\circ\text{C}, t_p = 1\text{ ms}$	40	A
RBSOA	$V_{GE} = \pm 15\text{ V}, T_J = 125^\circ\text{C}, R_G = 22\ \Omega$ Clamped inductive load, $L = 30\ \mu\text{H}$	$I_{CM} = 60$ $V_{CEK} < V_{CES}$	A
t_{SC} (SCSOA)	$V_{GE} = \pm 15\text{ V}, V_{CE} = 600\text{ V}, T_J = 125^\circ\text{C}$ $R_G = 22\ \Omega$, non repetitive	10	μs
P_C	$T_C = 25^\circ\text{C}$	IGBT	140 W
		Diode	50 W
T_J		-55 ... +150	$^\circ\text{C}$
T_{stg}		-40 ... +150	$^\circ\text{C}$
	Maximum lead temperature for soldering 1.6 mm (0.062 in.) from case for 10 s	300	$^\circ\text{C}$
M_d	Mounting torque	0.4 - 0.6	Nm
Weight		2	g

Features

- NPT IGBT technology
- low switching losses
- low tail current
- no latch up
- short circuit capability
- positive temperature coefficient for easy paralleling
- MOS input, voltage controlled
- optional ultra fast diode
- International standard package

Advantages

- Space savings
- High power density

Typical Applications

- AC motor speed control
- DC servo and robot drives
- DC choppers
- Uninterruptible power supplies (UPS)
- Switch-mode and resonant-mode power supplies

Symbol	Conditions	Characteristic Values ($T_J = 25^\circ\text{C}$, unless otherwise specified)		
		min.	typ.	max.
$V_{(BR)CES}$	$V_{GE} = 0\text{ V}$	600		V
$V_{GE(th)}$	$I_C = 0.4\text{ mA}, V_{CE} = V_{GE}$	3		5 V
I_{CES}	$V_{CE} = V_{CES}$	$T_J = 25^\circ\text{C}$		0.1 mA
		$T_J = 125^\circ\text{C}$	0.7	mA
I_{GES}	$V_{CE} = 0\text{ V}, V_{GE} = \pm 20\text{ V}$			$\pm 500\text{ nA}$
$V_{CE(sat)}$	$I_C = 20\text{ A}, V_{GE} = 15\text{ V}$		2.2	2.8 V

Symbol	Conditions	Characteristic Values		
		$(T_J = 25^\circ\text{C}, \text{ unless otherwise specified})$		
		min.	typ.	max.
C_{ies}	$V_{CE} = 25\text{ V}, V_{GE} = 0\text{ V}, f = 1\text{ MHz}$		800	pF
C_{oes}			85	pF
C_{res}			50	pF
Q_g	$I_C = 20\text{ A}, V_{GE} = 15\text{ V}, V_{CE} = 480\text{ V}$		70	nC
$t_{d(on)}$	Inductive load, $T_J = 125^\circ\text{C}$ $I_C = 20\text{ A}, V_{GE} = \pm 15\text{ V},$ $V_{CE} = 300\text{ V}, R_G = 22\ \Omega$		25	ns
t_r			30	ns
$t_{d(off)}$			260	ns
t_f			55	ns
E_{on}			0.9	mJ
E_{off}			0.4	mJ
R_{thJC}	Package with heatsink compound	0.5		0.9 K/W
R_{thCH}				K/W
R_{thCK}	Package with heatsink compound		0.25	K/W

Reverse Diode (FRED) [D1 version only]

Symbol	Conditions	Characteristic Values		
		$(T_J = 25^\circ\text{C}, \text{ unless otherwise specified})$		
		min.	typ.	max.
V_F	$I_F = 20\text{ A}, V_{GE} = 0\text{ V}$		2.1	2.4 V
	$I_F = 20\text{ A}, V_{GE} = 0\text{ V}, T_J = 125^\circ\text{C}$		1.6	V
I_F	$T_C = 25^\circ\text{C}$			25 A
	$T_C = 90^\circ\text{C}$			15 A
I_{RM}	$I_F = 10\text{ A}, -di_F/dt = 400\text{ A}/\mu\text{s}, V_R = 300\text{ V}$		11	A
t_{rr}	$V_{GE} = 0\text{ V}, T_J = 125^\circ\text{C}$		80	ns
t_{rr}	$I_F = 1\text{ A}, -di_F/dt = 100\text{ A}/\mu\text{s}, V_R = 30\text{ V}, V_{GE} = 0\text{ V}$		40	ns
R_{thJC}				2.5 K/W

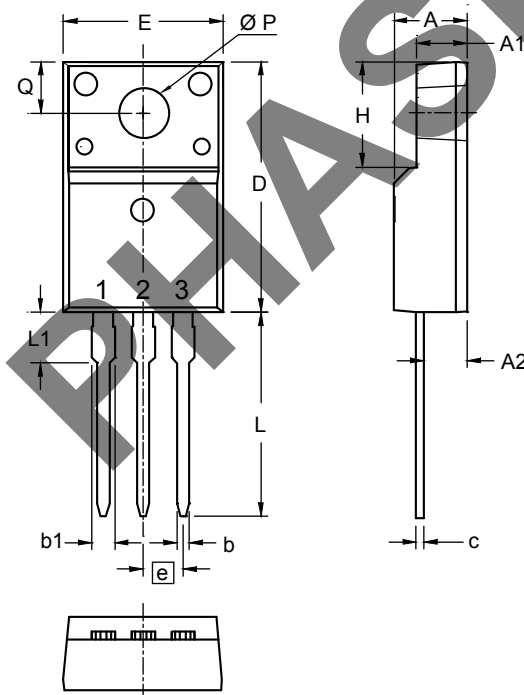
TO-220 AB Outline

Dim.	Millimeters		Inches	
	min	max	min	max
A	4.50	4.90	0.177	0.193
A1	2.34	2.74	0.092	0.108
A2	2.56	2.96	0.101	0.117
b	0.70	0.90	0.028	0.035
c	0.45	0.60	0.018	0.024
D	15.67	16.07	0.617	0.633
E	9.96	10.36	0.392	0.408
e	2.54 BSC		0.100 BSC	
H	6.48	6.88	0.255	0.271
L	12.68	13.28	0.499	0.523
L1	3.03	3.43	0.119	0.135
ØP	3.08	3.28	0.121	0.129
Q	3.20	3.40	0.126	0.134

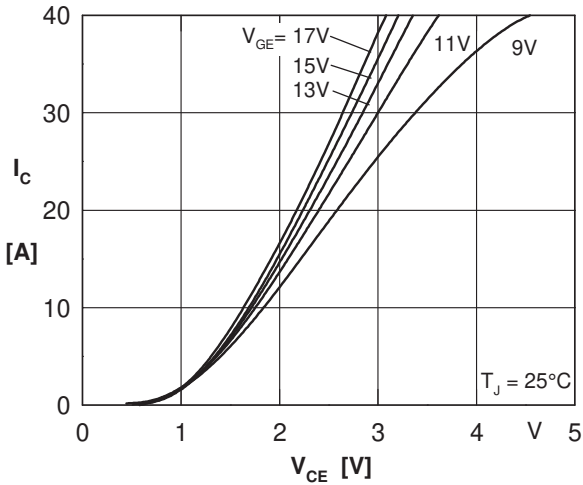

Fig. 1 Typ. output characteristics

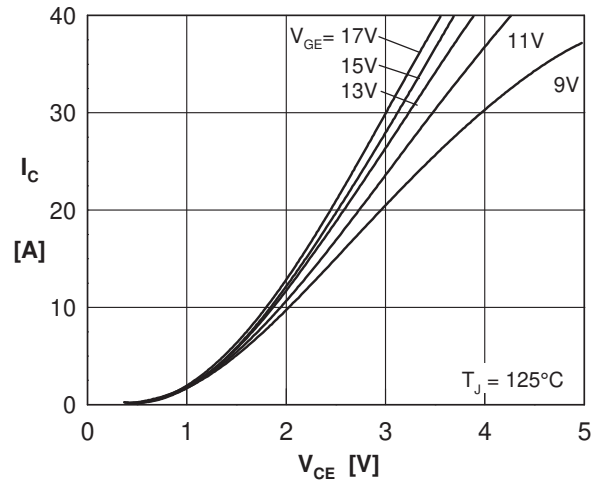

Fig. 2 Typ. output characteristics

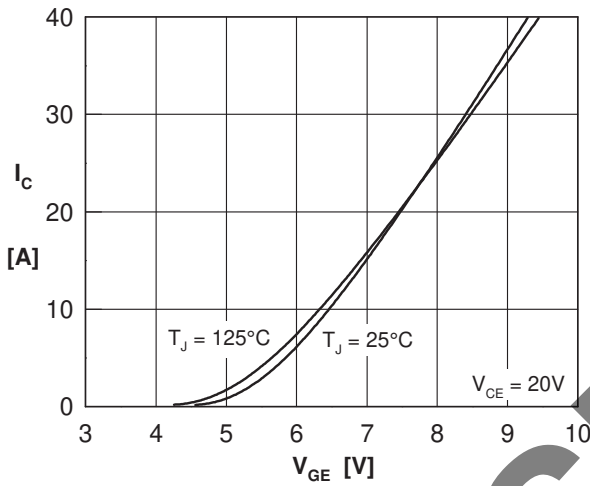

Fig. 3 Typ. transfer characteristics

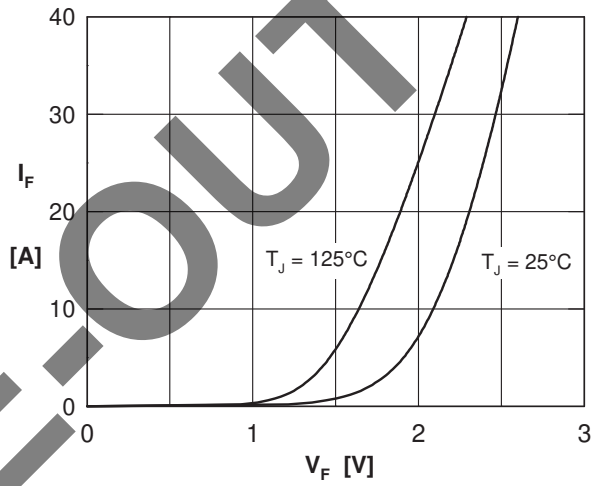

Fig. 4 Typ. forward characteristics of free wheeling diode

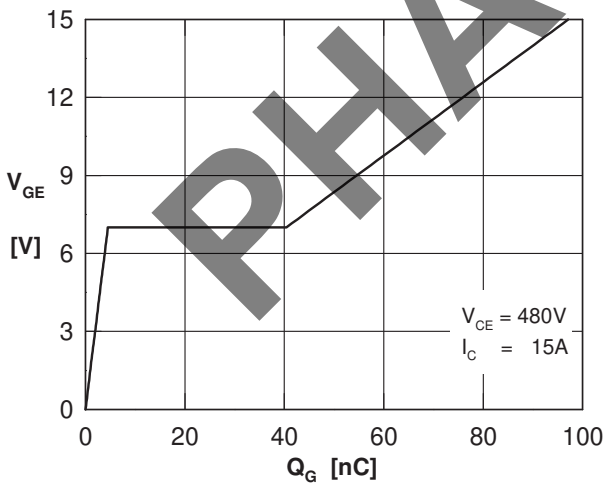

Fig. 5 Typ. turn on gate charge

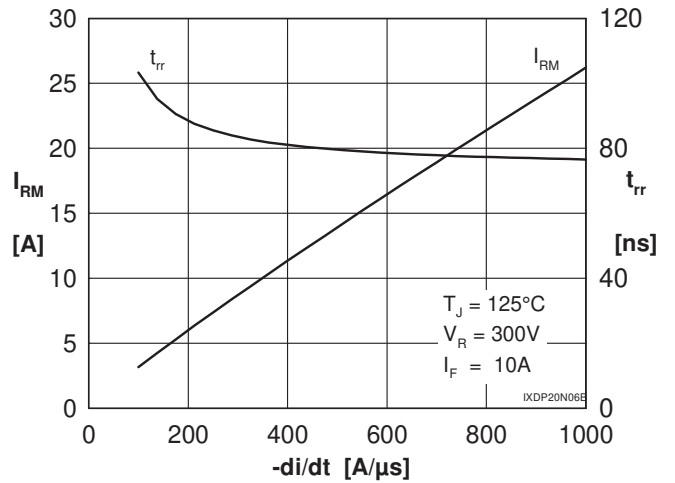

Fig. 6 Typ. turn off characteristics of free wheeling diode

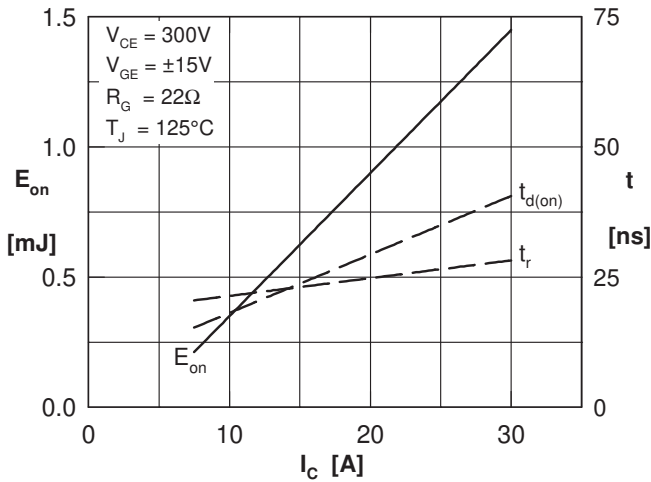

Fig. 7 Typ. turn on energy and switching times versus collector current

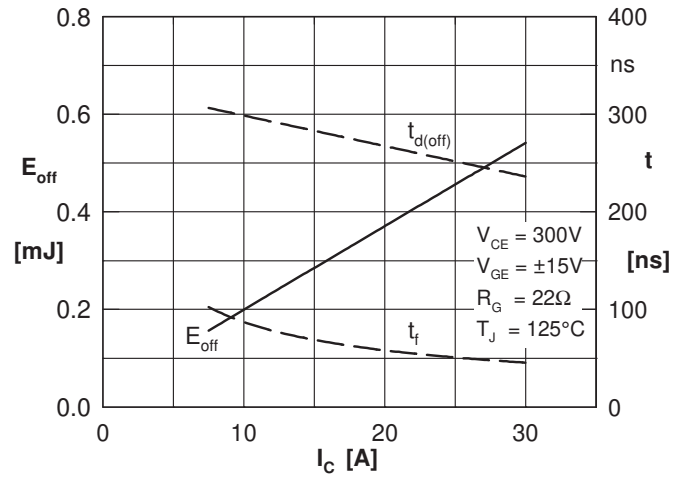

Fig. 8 Typ. turn off energy and switching times versus collector current

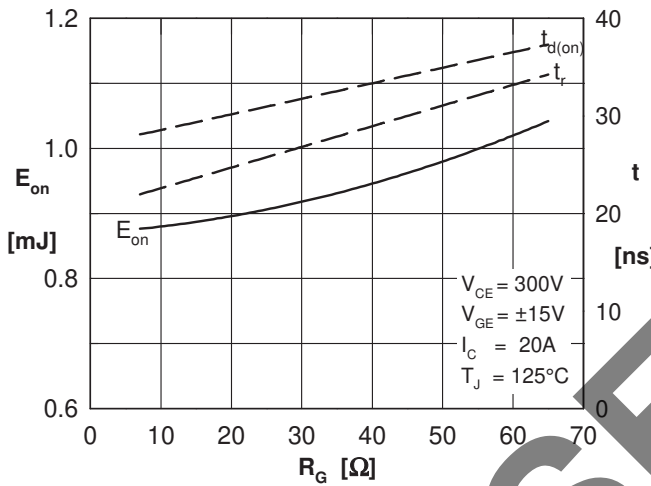

Fig. 9 Typ. turn on energy and switching times versus gate resistor

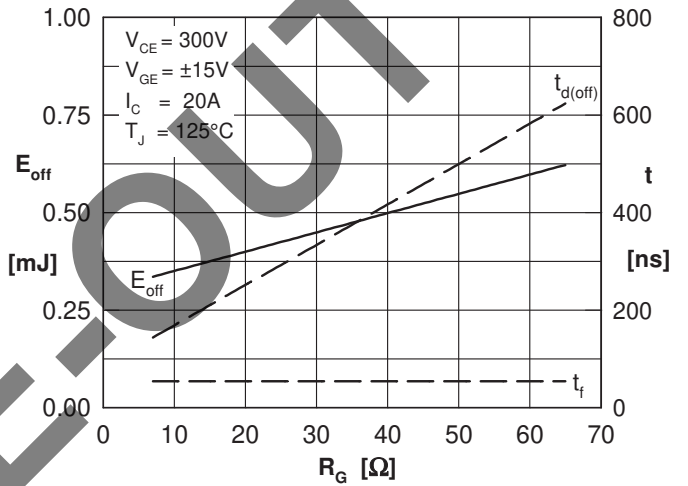

Fig. 10 Typ. turn off energy and switching times versus gate resistor

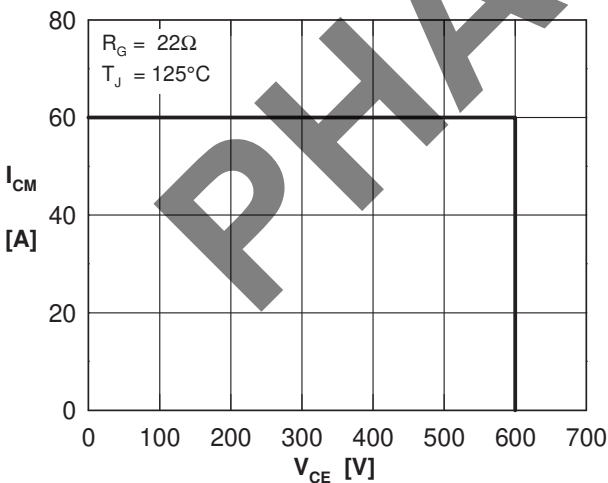

Fig. 5 Typ. turn on gate charge

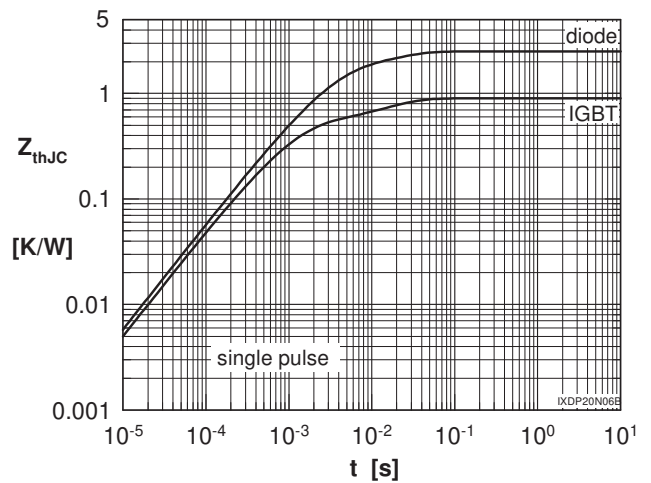

Fig. 6 Typ. turn off characteristics of free wheeling diode