

**High Voltage  
BIMOSFET™ Monolithic  
Bipolar MOS Transistor  
Extended FBSOA**

**IXCH36N250  
IXCK36N250**

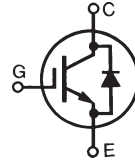

$$V_{CES} = 2500V$$

$$I_{C110} = 36A$$

$$V_{CE(sat)} \leq 3.3V$$

Symbol	Test Conditions	Maximum Ratings	
$V_{CES}$	$T_C = 25^\circ C$ to $150^\circ C$	2500	V
$V_{CGR}$	$T_J = 25^\circ C$ to $150^\circ C$ , $R_{GE} = 1M\Omega$	2500	V
$V_{GES}$	Continuous	$\pm 25$	V
$V_{GEM}$	Transient	$\pm 35$	V
$I_{C25}$	$T_C = 25^\circ C$	73	A
$I_{C110}$	$T_C = 110^\circ C$	36	A
$I_{CM}$	$T_C = 25^\circ C$ , 1ms	360	A
<b>SSOA (RBSOA)</b>	$V_{GE} = 15V$ , $T_{VJ} = 125^\circ C$ , $R_G = 20\Omega$ Clamped Inductive Load	$I_{CM} = 144$ $V_{CE} \leq 0.8 \cdot V_{CES}$	A
<b><math>T_{SC}</math> (SCSOA)</b>	$V_{GE} = 15V$ , $T_J = 125^\circ C$ , $R_G = 82\Omega$ , $V_{CE} = 1250V$ , Non-Repetitive	10	$\mu s$
$P_C$	$T_C = 25^\circ C$	595	W
$T_J$		-55 ... +150	$^\circ C$
$T_{JM}$		150	$^\circ C$
$T_{stg}$		-55 ... +150	$^\circ C$
$T_L$	1.6mm (0.062 in.) from Case for 10s	300	$^\circ C$
$T_{SOLD}$	Plastic Body for 10 seconds	260	$^\circ C$
$M_d$	Mounting Torque	1.13/10	Nm/lb.in.
<b>Weight</b>	TO-247	6	g
	TO-264	10	g

**TO-247 AD**

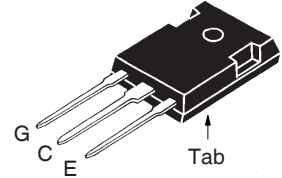

**TO-264**

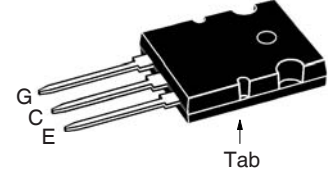

G = Gate                      E = Emitter  
C = Collector                Tab = Collector

**Features**

- High Blocking Voltage
- High Peak Current Capability
- Anti-Parallel Diode
- Low Saturation Voltage
- Extended FBSOA and SCSOA

**Advantages**

- Low Gate Drive Requirement
- High Power Density

**Applications**

- Switch-Mode and Resonant-Mode Power Supplies
- Uninterruptible Power Supplies (UPS)
- Laser Generators
- Capacitor Discharge Circuits
- AC Switches
- Protection Circuits

Symbol	Test Conditions ( $T_J = 25^\circ C$ , Unless Otherwise Specified)	Characteristic Values		
		Min.	Typ.	Max.
$BV_{CES}$	$I_C = 250\mu A$ , $V_{GE} = 0V$	2500		V
$V_{GE(th)}$	$I_C = 250\mu A$ , $V_{CE} = V_{GE}$	4.0		6.5 V
$I_{CES}$	$V_{CE} = V_{CES}$ , $V_{GE} = 0V$ $T_J = 125^\circ C$			50 $\mu A$ 1.75 mA
$I_{GES}$	$V_{CE} = 0V$ , $V_{GE} = \pm 25V$			$\pm 100$ nA
$V_{CE(sat)}$	$I_C = 36A$ , $V_{GE} = 15V$ , Note 1 $T_J = 125^\circ C$	2.6		3.3 V
		3.0		V

### Symbol Test Conditions

( $T_J = 25^\circ\text{C}$  Unless Otherwise Specified)

### Characteristic Values

Min. Typ. Max.

$g_{fs}$	$I_C = 36\text{A}, V_{CE} = 10\text{V}$ , Note 1	22	33	S
$C_{ies}$	$V_{CE} = 25\text{V}, V_{GE} = 0\text{V}, f = 1\text{MHz}$	3980		pF
$C_{oes}$		170		pF
$C_{res}$		60		pF
$Q_g$	$I_C = 36\text{A}, V_{GE} = 15\text{V}, V_{CE} = 1000\text{V}$	177		nC
$Q_{ge}$		30		nC
$Q_{gc}$		80		nC
$t_{d(on)}$	<b>Resistive Switching Times, <math>T_J = 25^\circ\text{C}</math></b> $I_C = 36\text{A}, V_{GE} = 15\text{V}$ $V_{CE} = 1250\text{V}, R_G = 20\Omega$	115		ns
$t_r$		580		ns
$t_{d(off)}$		430		ns
$t_f$		880		ns
$t_{d(on)}$	<b>Resistive Switching Times, <math>T_J = 125^\circ\text{C}</math></b> $I_C = 36\text{A}, V_{GE} = 15\text{V}$ $V_{CE} = 1250\text{V}, R_G = 20\Omega$	105		ns
$t_r$		830		ns
$t_{d(off)}$		480		ns
$t_f$		900		ns
$R_{thJC}$			0.21	$^\circ\text{C/W}$
$R_{thCS}$	TO-247	0.21		$^\circ\text{C/W}$
	TO-264	0.15		$^\circ\text{C/W}$

### Reverse Diode

### Symbol Test Conditions

( $T_J = 25^\circ\text{C}$  Unless Otherwise Specified)

### Characteristic Values

Min. Typ. Max

$V_F$	$I_F = 36\text{A}, V_{GE} = 0\text{V}$ , Note 1		2.5	V
$t_{rr}$	$I_F = 23\text{A}, V_{GE} = 0\text{V}, -di_F/dt = 100\text{A}/\mu\text{s}$	1.7		$\mu\text{s}$
$I_{RM}$		43		A

Note:

1. Pulse test,  $t \leq 300\mu\text{s}$ , duty cycle,  $d \leq 2\%$ .

Additional provisions for lead to lead voltage isolation are required at  $V_{CE} > 1200\text{V}$ .

IXYS Reserves the Right to Change Limits, Test Conditions and Dimensions.

IXYS MOSFETs and IGBTs are covered by one or more of the following U.S. patents:	4,835,592	4,931,844	5,049,961	5,237,481	6,162,665	6,404,065 B1	6,683,344	6,727,585	7,005,734 B2	7,157,338B2
	4,850,072	5,017,508	5,063,307	5,381,025	6,259,123 B1	6,534,343	6,710,405 B2	6,759,692	7,063,975 B2	
	4,881,106	5,034,796	5,187,117	5,486,715	6,306,728 B1	6,583,505	6,710,463	6,771,478 B2	7,071,537	

### TO-247 (IXCH) Outline

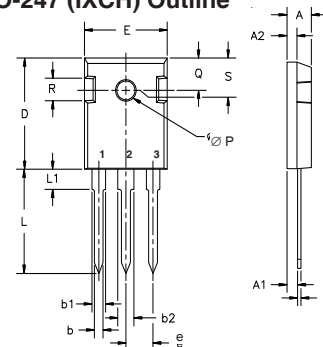

Terminals: 1 - Gate 2 - Collector  
3 - Emitter

Dim.	Millimeter		Inches	
	Min.	Max.	Min.	Max.
A	4.7	5.3	.185	.209
A <sub>1</sub>	2.2	2.54	.087	.102
A <sub>2</sub>	2.2	2.6	.059	.098
b	1.0	1.4	.040	.055
b <sub>1</sub>	1.65	2.13	.065	.084
b <sub>2</sub>	2.87	3.12	.113	.123
C	.4	.8	.016	.031
D	20.80	21.46	.819	.845
E	15.75	16.26	.610	.640
e	5.20	5.72	0.205	0.225
L	19.81	20.32	.780	.800
L1		4.50		.177
∅P	3.55	3.65	.140	.144
Q	5.89	6.40	0.232	0.252
R	4.32	5.49	.170	.216
S	6.15	BSC	242	BSC

### TO-264 (IXCK) Outline

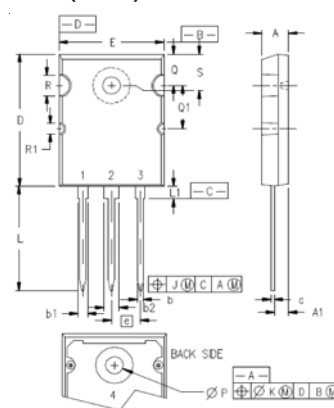

Terminals: 1 = Gate  
2,4 = Collector  
3 = Emitter

SYM	INCHES		MILLIMETERS	
	MIN	MAX	MIN	MAX
A	.185	.209	4.70	5.31
A1	.102	.118	2.59	3.00
b1	.037	.055	0.94	1.40
b2	.110	.126	2.79	3.20
c	.017	.029	0.43	0.74
D	1.007	1.047	25.58	26.59
E	.760	.799	19.30	20.29
e	.215BSC		5.46 BSC	
J	.000	.010	0.00	0.25
K	.000	.010	0.00	0.25
L	.779	.842	19.79	21.39
L1	.087	.102	2.21	2.59
∅P	.122	.136	3.10	3.51
Q	.240	.256	6.10	6.50
Q1	.330	.346	8.38	8.79
∅R	.155	.187	3.94	4.75
∅R1	.085	.093	2.16	2.36
S	.243	.253	6.17	6.43

**Fig. 1. Output Characteristics @  $T_J = 25^\circ\text{C}$**

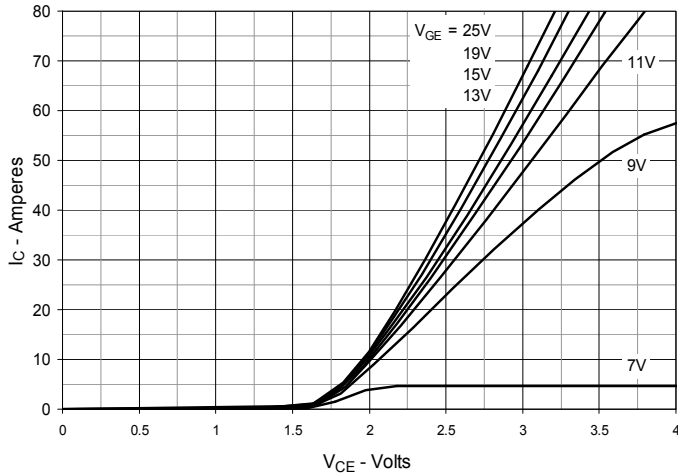

**Fig. 2. Extended Output Characteristics @  $T_J = 25^\circ\text{C}$**

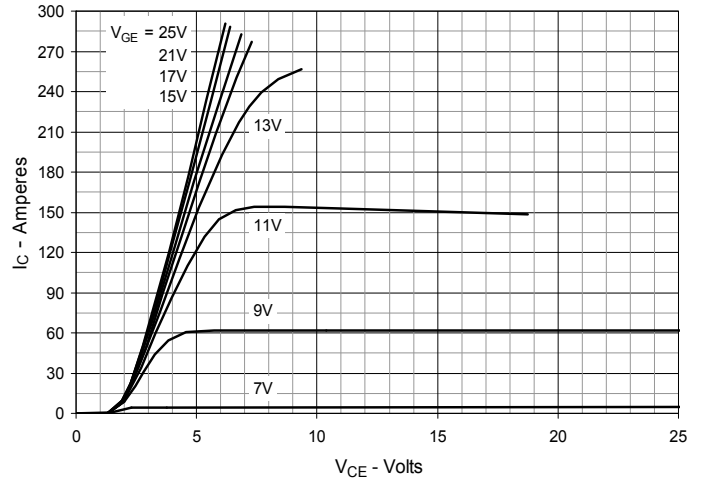

**Fig. 3. Output Characteristics @  $T_J = 125^\circ\text{C}$**



**Fig. 4. Dependence of  $V_{CE(sat)}$  on Junction Temperature**

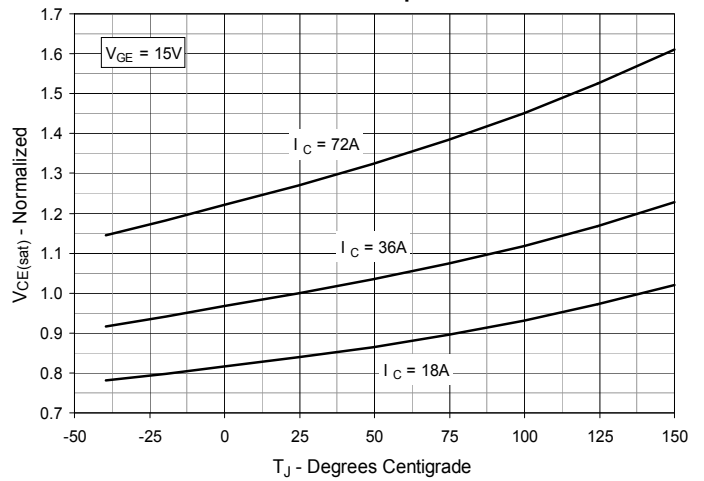

**Fig. 5. Collector-to-Emitter Voltage vs. Gate-to-Emitter Voltage**

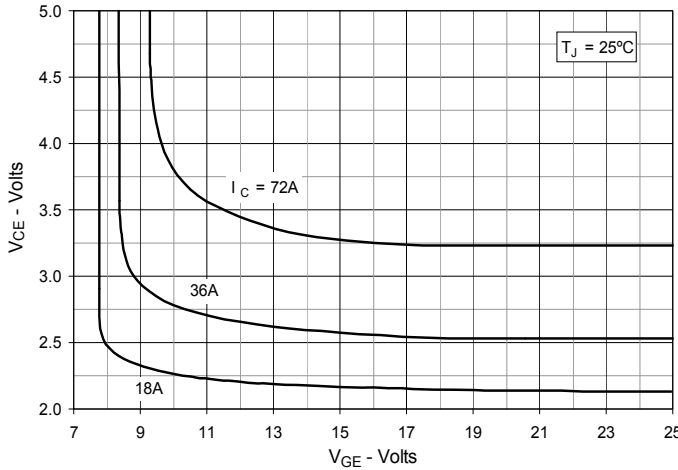

**Fig. 6. Input Admittance**

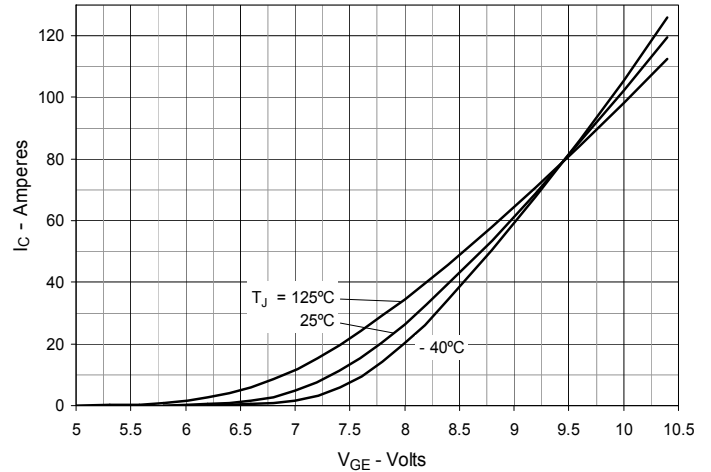

Fig. 7. Transconductance

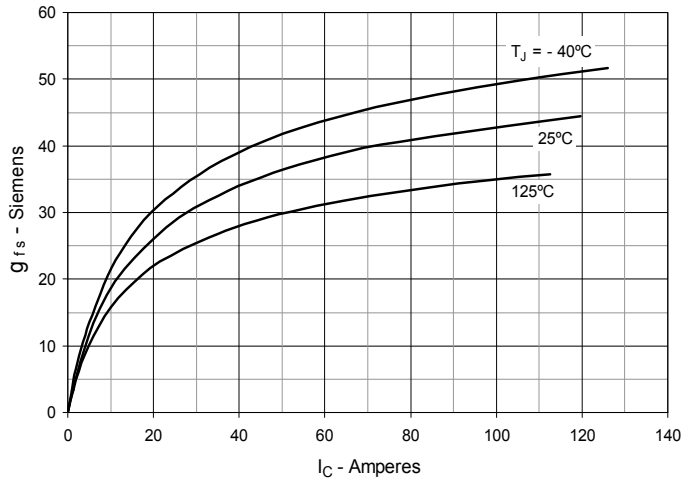

Fig. 8. Forward Voltage Drop of Intrinsic Diode

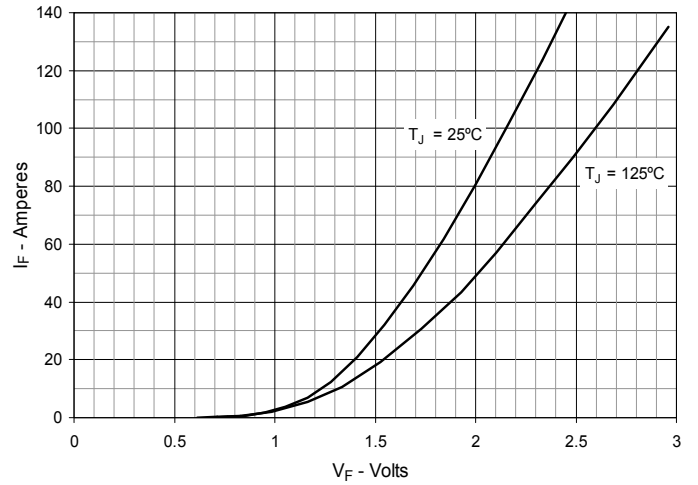

Fig. 9. Gate Charge

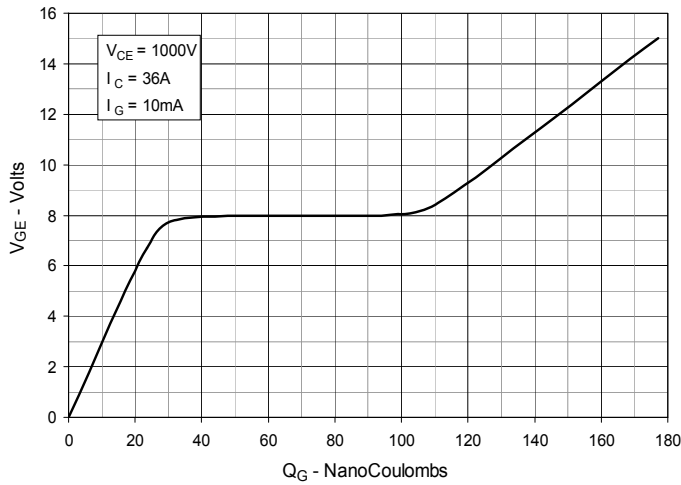

Fig. 10. Capacitance

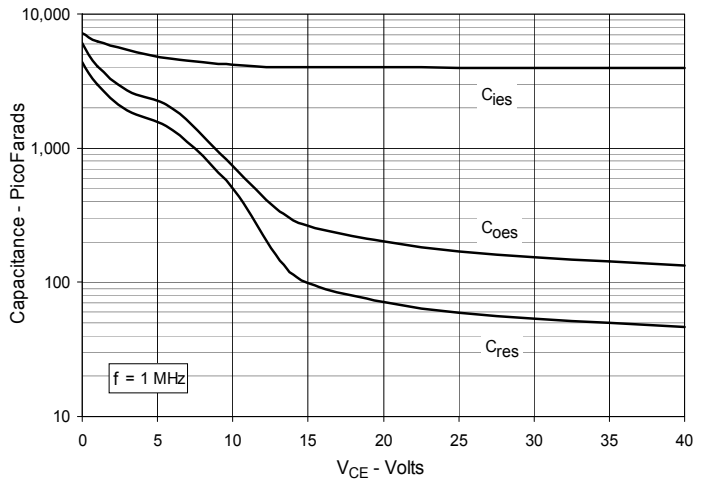

Fig. 11. Reverse-Bias Safe Operating Area

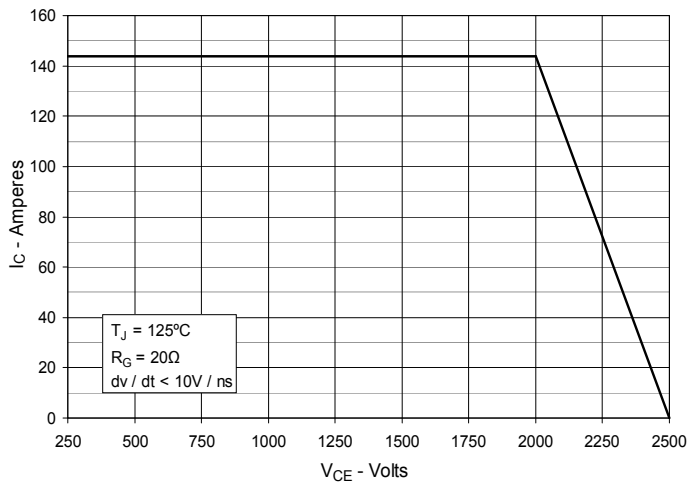
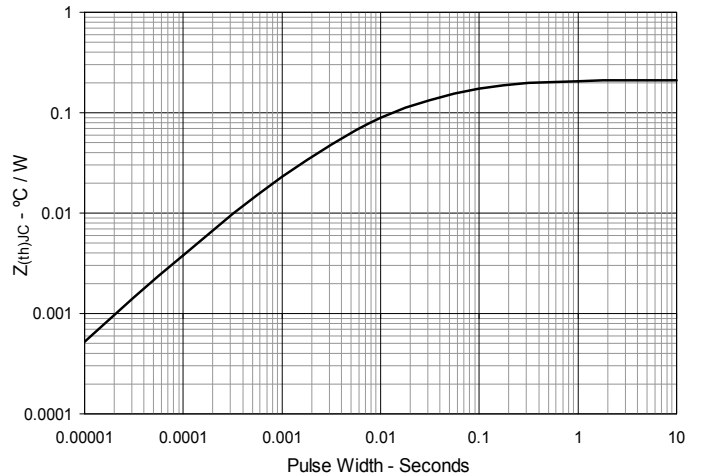
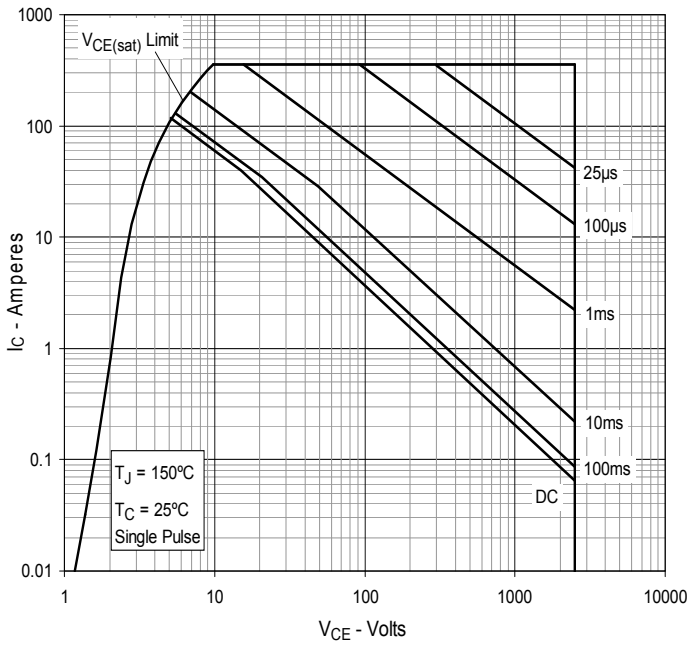

Fig. 12. Maximum Transient Thermal Impedance



**Fig. 13. Forward-Bias Safe Operating Area @  $T_C = 25^\circ\text{C}$**



**Fig. 14. Forward-Bias Safe Operating Area @  $T_C = 75^\circ\text{C}$**

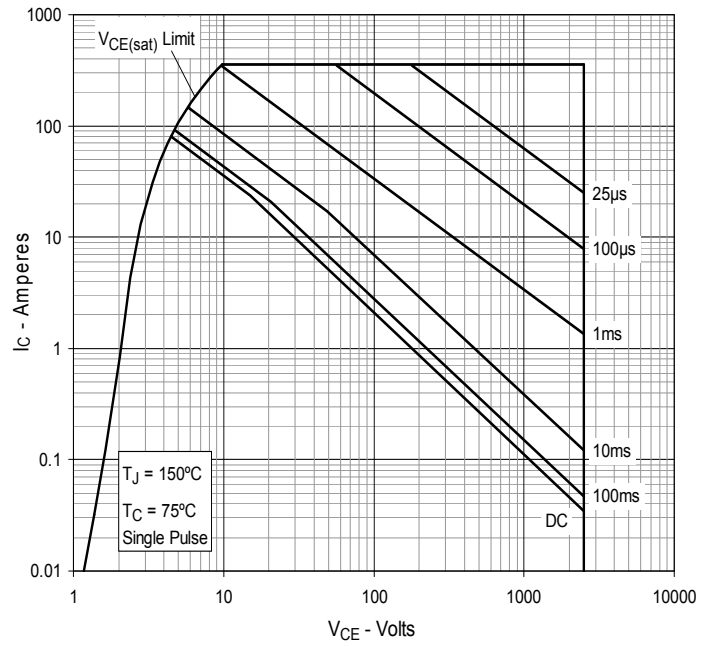



---

Disclaimer Notice - Information furnished is believed to be accurate and reliable. However, users should independently evaluate the suitability of and test each product selected for their own applications. Littelfuse products are not designed for, and may not be used in, all applications. Read complete Disclaimer Notice at [www.littelfuse.com/disclaimer-electronics](http://www.littelfuse.com/disclaimer-electronics).