

**BiMOSFET™ Monolithic  
Bipolar MOS Transistor  
High Voltage,  
High Frequency**

**IXBX50N360HV**



$$V_{CES} = 3600V$$

$$I_{C110} = 50A$$

$$V_{CE(sat)} \leq 2.9V$$

Symbol	Test Conditions	Maximum Ratings	
$V_{CES}$	$T_J = 25^\circ C$ to $150^\circ C$	3600	V
$V_{CGR}$	$T_J = 25^\circ C$ to $150^\circ C$ , $R_{GE} = 1M\Omega$	3600	V
$V_{GES}$	Continuous	$\pm 20$	V
$V_{GEM}$	Transient	$\pm 30$	V
$I_{C25}$	$T_C = 25^\circ C$	125	A
$I_{C110}$	$T_C = 110^\circ C$	50	A
$I_{CM}$	$T_C = 25^\circ C$ , 1ms	420	A
<b>SSOA (RBSOA)</b>	$V_{GE} = 15V$ , $T_{VJ} = 125^\circ C$ , $R_G = 5\Omega$ Clamped Inductive Load	$I_{CM} = 200$ $0.8 \cdot V_{CES}$	A V
<b><math>T_{SC}</math> (SCSOA)</b>	$V_{GE} = 15V$ , $T_J = 125^\circ C$ , $R_G = 10\Omega$ , $V_{CE} = 1500V$ , Non-Repetitive	10	$\mu s$
$P_C$	$T_C = 25^\circ C$	660	W
$T_J$		- 55 ... +150	$^\circ C$
$T_{JM}$		150	$^\circ C$
$T_{stg}$		- 55 ... +150	$^\circ C$
$T_L$	Maximum Lead Temperature for Soldering	300	$^\circ C$
$T_{SOLD}$	Plastic Body for 10s	260	$^\circ C$
$F_C$	Mounting Force	20..120/4.5..27	N/lb
<b>Weight</b>		6	g

TO-247PLUS-HV

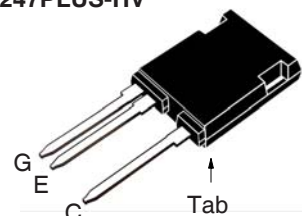

G = Gate                      E = Emitter  
C = Collector                Tab = Collector

**Features**

- High Blocking Voltage
- High Voltage Package
- Low Conduction Losses

**Advantages**

- Easy to Mount
- Space Savings
- High Power Density

**Applications**

- Uninterruptible Power Supplies (UPS)
- Switch-Mode and Resonant-Mode Power Supplies
- Capacitor Discharge Circuits
- Laser Generators

Symbol	Test Conditions ( $T_J = 25^\circ C$ Unless Otherwise Specified)	Characteristic Values		
		Min.	Typ.	Max.
$BV_{CES}$	$I_C = 250\mu A$ , $V_{GE} = 0V$	3600		V
$V_{GE(th)}$	$I_C = 250\mu A$ , $V_{CE} = V_{GE}$	3.0		5.0 V
$I_{CES}$	$V_{CE} = 0.8 \cdot V_{CES}$ , $V_{GE} = 0V$ Note 2, $T_J = 125^\circ C$			25 $\mu A$ 1 mA
$I_{GES}$	$V_{CE} = 0V$ , $V_{GE} = \pm 20V$			$\pm 200$ nA
$V_{CE(SAT)}$	$I_C = 50A$ , $V_{GE} = 15V$ , Note 1 $T_J = 125^\circ C$		2.4 3.0	V V

Symbol	Test Conditions ( $T_J = 25^\circ\text{C}$ Unless Otherwise Specified)	Characteristic Values		
		Min.	Typ.	Max.
$g_{fs}$	$I_C = 50\text{A}, V_{CE} = 10\text{V}, \text{Note 1}$	24	40	S
$C_{ies}$	$V_{CE} = 25\text{V}, V_{GE} = 0\text{V}, f = 1\text{MHz}$		3990	pF
$C_{oes}$			195	pF
$C_{res}$			100	pF
$Q_{g(on)}$	$I_C = 50\text{A}, V_{GE} = 15\text{V}, V_{CE} = 1000\text{V}$		210	nC
$Q_{ge}$			27	nC
$Q_{gc}$			77	nC
$t_{d(on)}$	<b>Resistive load, <math>T_J = 25^\circ\text{C}</math></b> $I_C = 50\text{A}, V_{GE} = 15\text{V}$ $V_{CE} = 960\text{V}, R_G = 5\Omega$		46	ns
$t_r$			420	ns
$t_{d(off)}$			205	ns
$t_f$			1750	ns
$t_{d(on)}$	<b>Resistive load, <math>T_J = 125^\circ\text{C}</math></b> $I_C = 50\text{A}, V_{GE} = 15\text{V}$ $V_{CE} = 960\text{V}, R_G = 5\Omega$		44	ns
$t_r$			845	ns
$t_{d(off)}$			210	ns
$t_f$			1670	ns
$R_{thJC}$				0.19 $^\circ\text{C/W}$
$R_{thCS}$		0.15		$^\circ\text{C/W}$

**Reverse Diode**

Symbol	Test Conditions ( $T_J = 25^\circ\text{C}$ Unless Otherwise Specified)	Characteristic Values		
		Min.	Typ.	Max
$V_F$	$I_F = 50\text{A}, V_{GE} = 0\text{V}, \text{Note 1}$			3.0 V
$t_{rr}$	$I_F = 25\text{A}, V_{GE} = 0\text{V}, -di_F/dt = 100\text{A}/\mu\text{s}$ $V_R = 100\text{V}, V_{GE} = 0\text{V}$		1.7	$\mu\text{s}$
$I_{RM}$			48	A
$Q_{RM}$			40	$\mu\text{C}$

**Notes:**

1. Pulse test,  $t \leq 300\mu\text{s}$ , duty cycle,  $d \leq 2\%$ .
2. Device must be heatsunk for high-temperature leakage current measurements to avoid thermal runaway.

**ADVANCE TECHNICAL INFORMATION**

The product presented herein is under development. The Technical Specifications offered are derived from a subjective evaluation of the design, based upon prior knowledge and experience, and constitute a "considered reflection" of the anticipated result. IXYS reserves the right to change limits, test conditions, and dimensions without notice.

IXYS Reserves the Right to Change Limits, Test Conditions and Dimensions.

IXYS MOSFETs and IGBTs are covered by one or more of the following U.S. patents:	4,835,592	4,931,844	5,049,961	5,237,481	6,162,665	6,404,065 B1	6,683,344	6,727,585	7,005,734 B2	7,157,338B2
	4,860,072	5,017,508	5,063,307	5,381,025	6,259,123 B1	6,534,343	6,710,405 B2	6,759,692	7,063,975 B2	
	4,881,106	5,034,796	5,187,117	5,486,715	6,306,728 B1	6,583,505	6,710,463	6,771,478 B2	7,071,537	

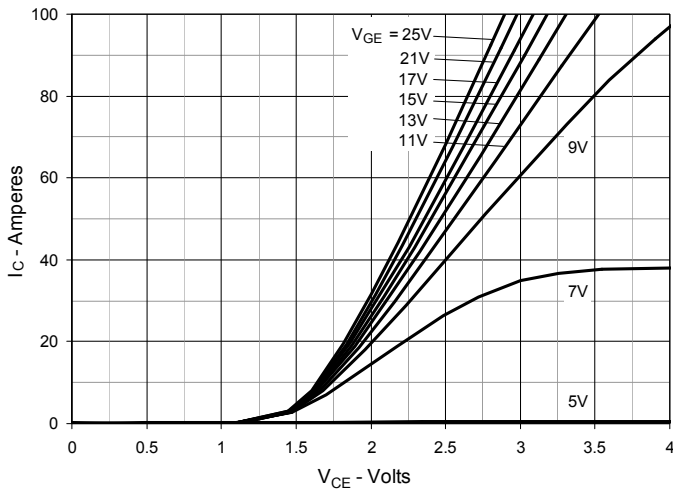
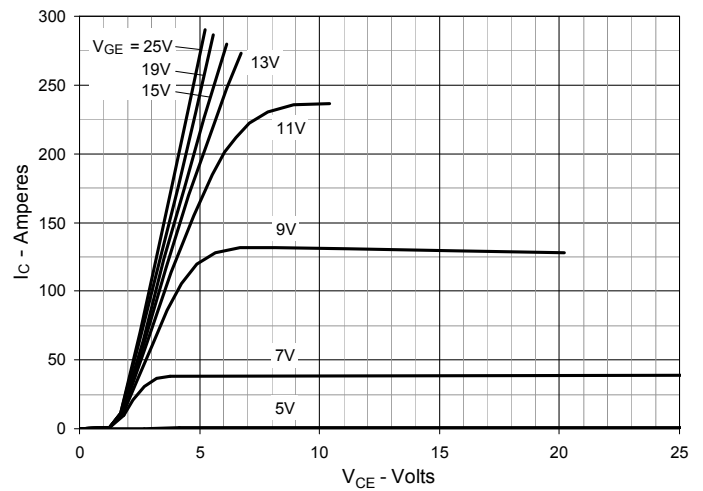
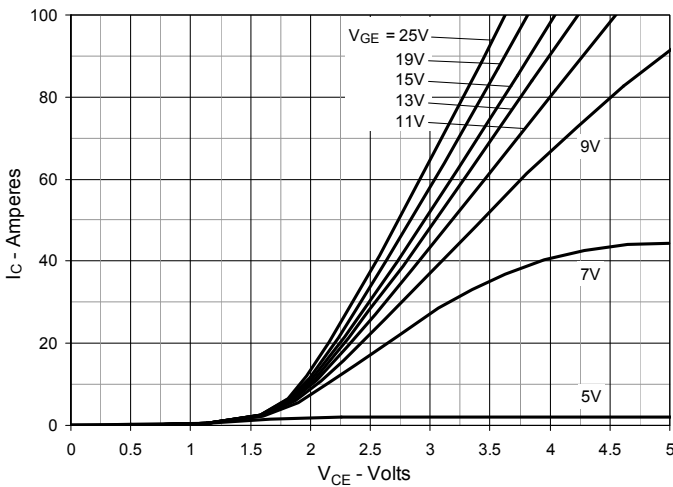
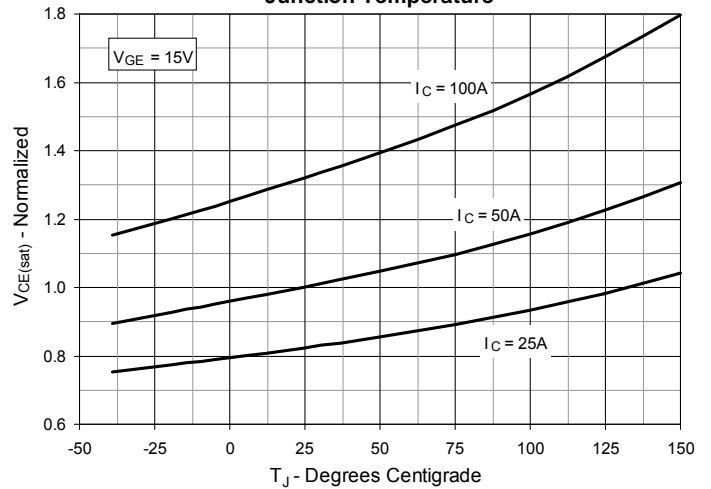
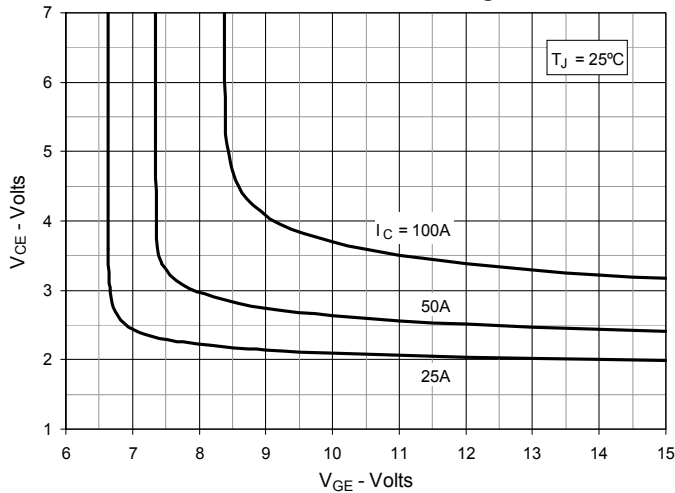
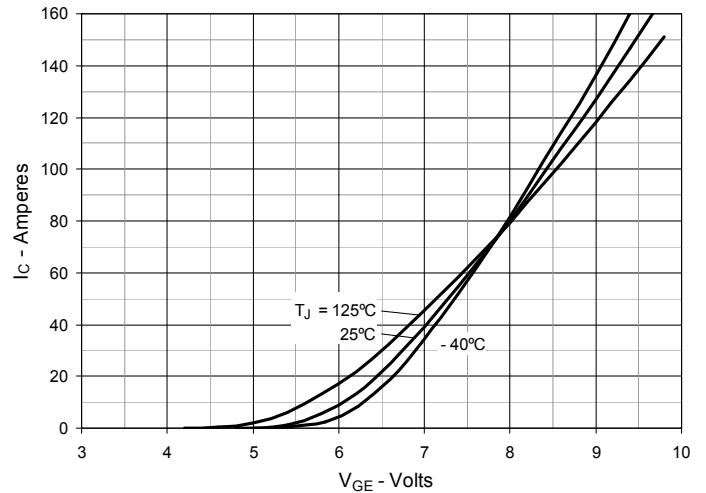
**Fig. 1. Output Characteristics @  $T_J = 25^\circ\text{C}$** 

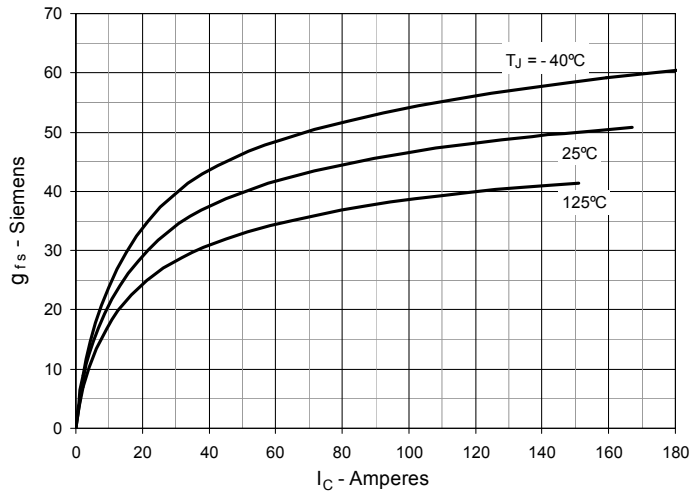
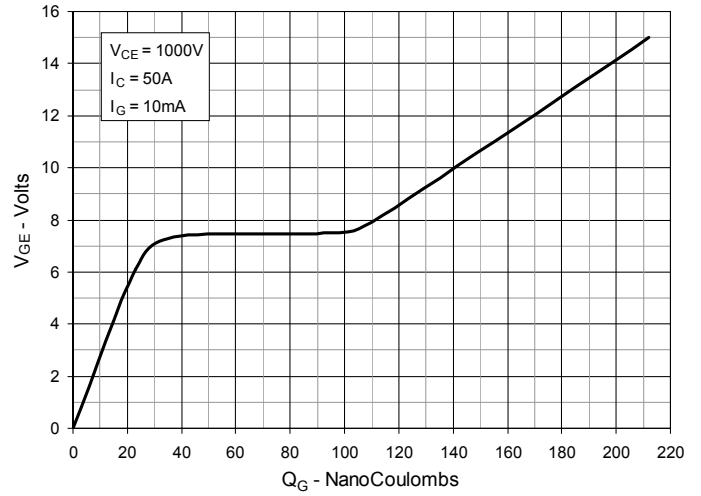
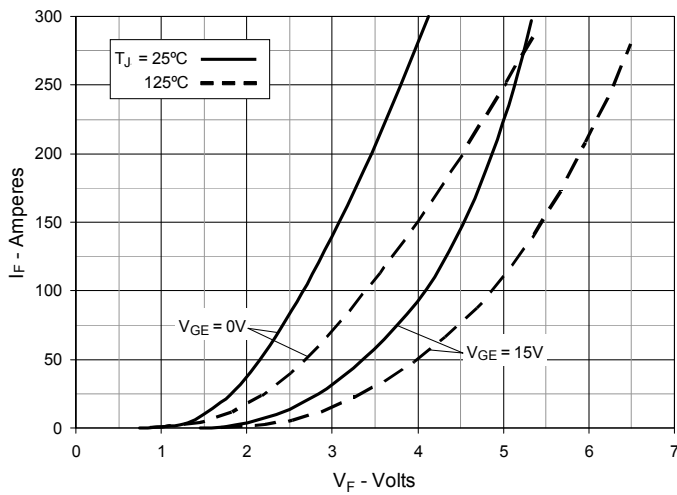
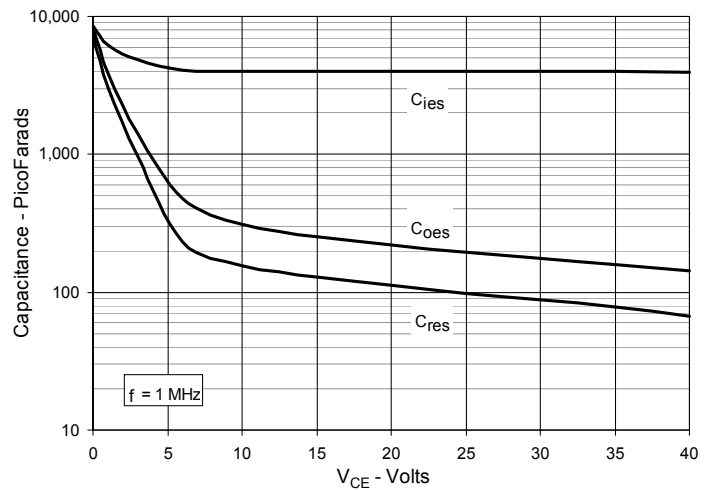
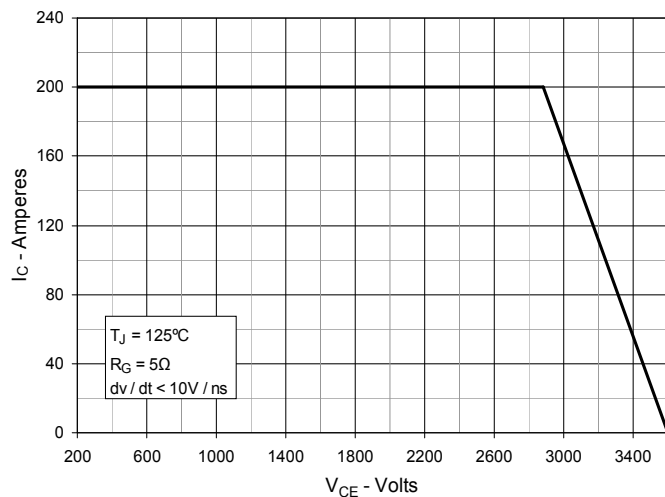
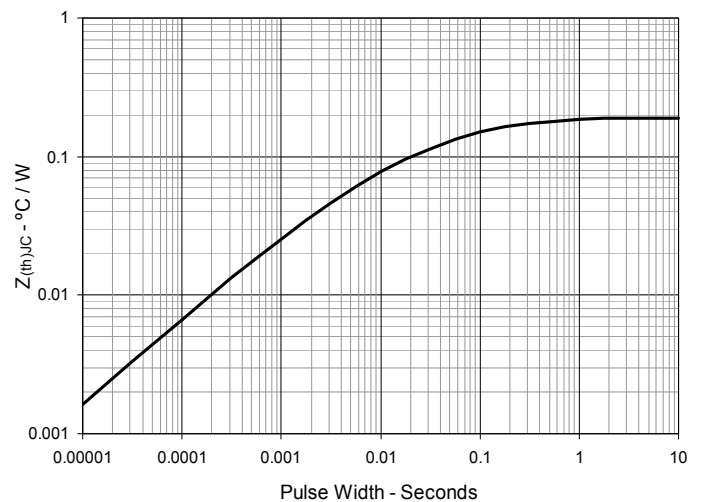
**Fig. 2. Extended Output Characteristics @  $T_J = 25^\circ\text{C}$** 

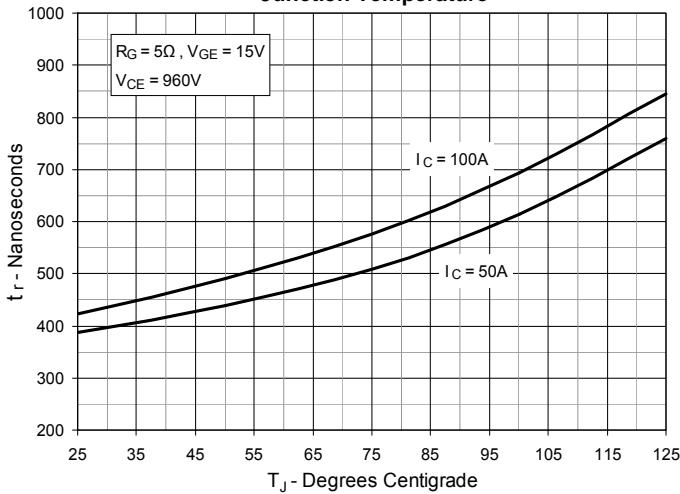
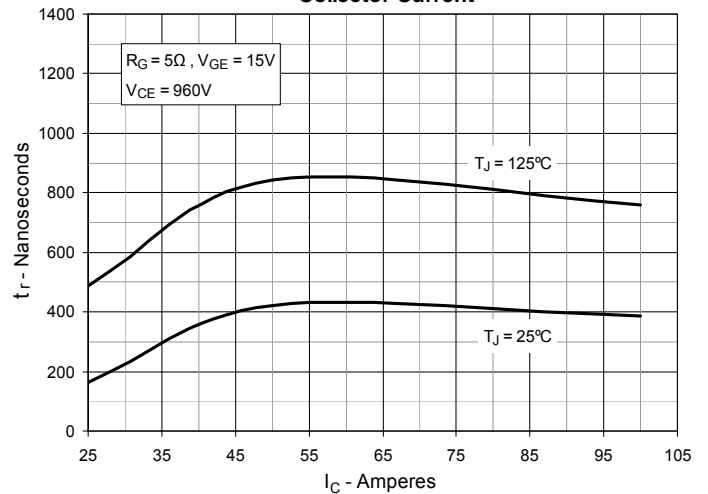
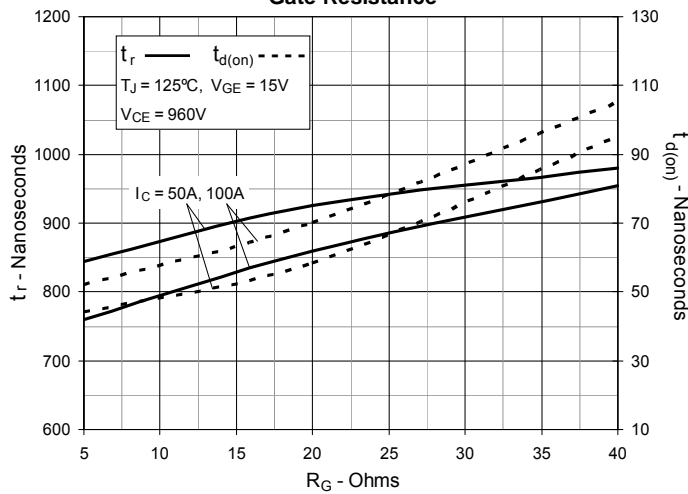
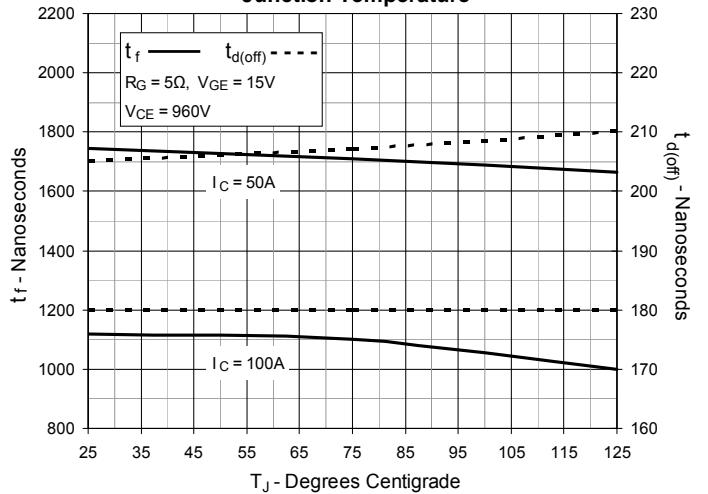
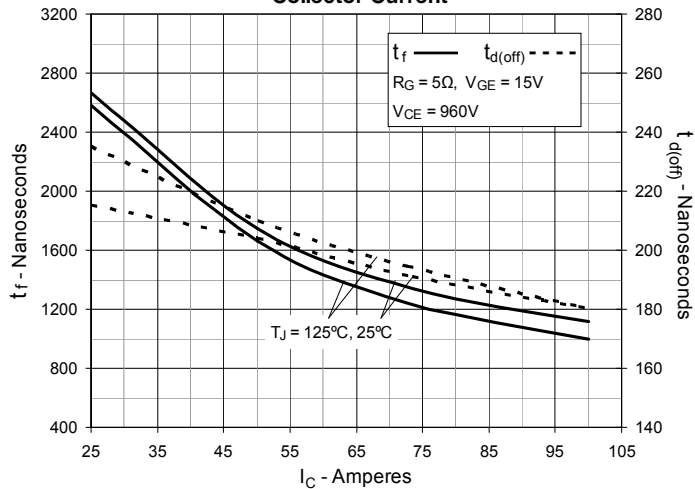
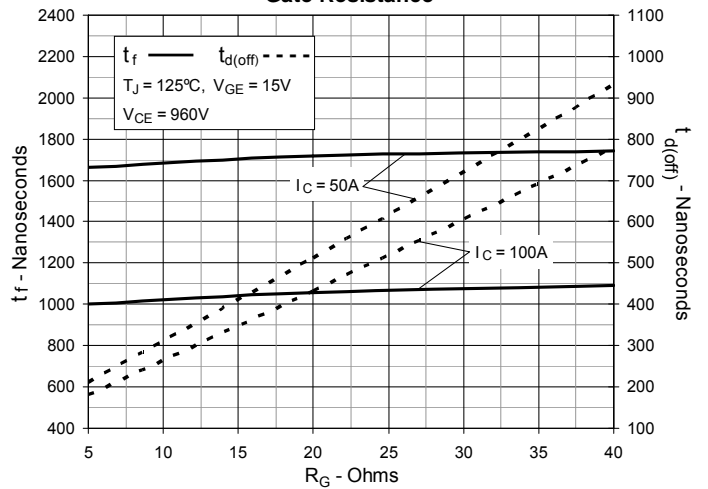
**Fig. 3. Output Characteristics @  $T_J = 125^\circ\text{C}$** 

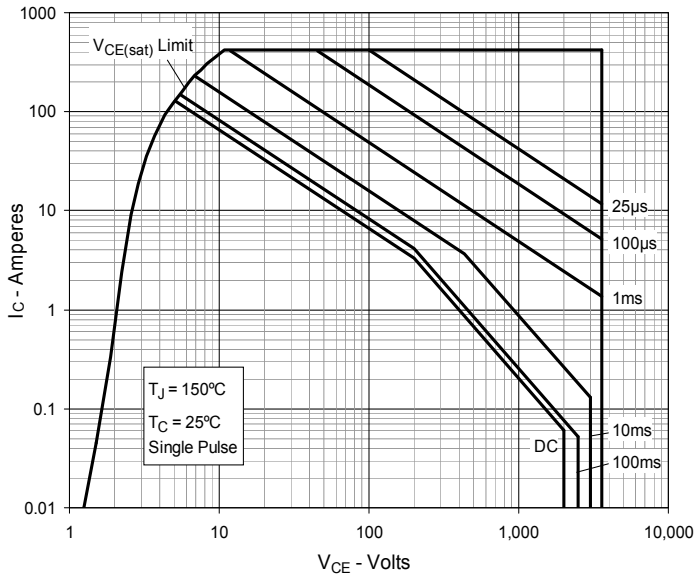
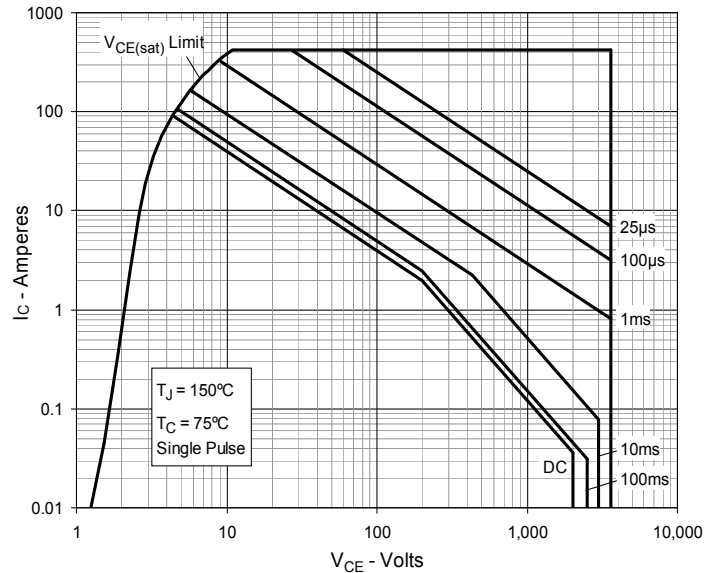
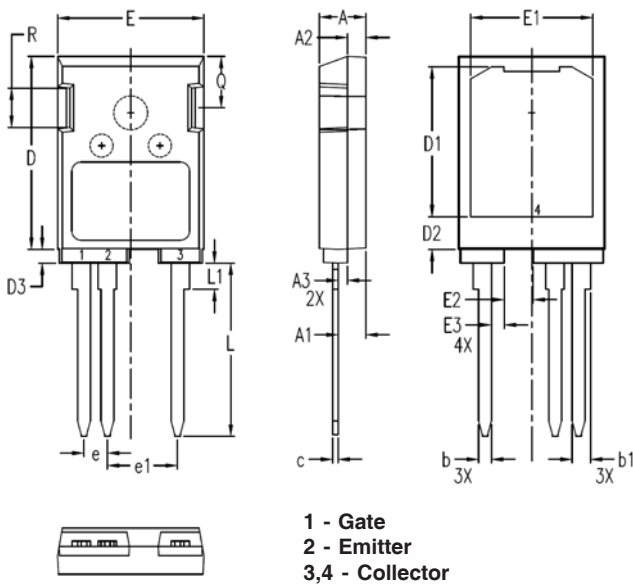
**Fig. 4. Dependence of  $V_{CE(sat)}$  on Junction Temperature**

**Fig. 5. Collector-to-Emitter Voltage vs. Gate-to-Emitter Voltage**

**Fig. 6. Input Admittance**

**Fig. 7. Transconductance**

**Fig. 8. Gate Charge**

**Fig. 9. Forward Voltage Drop of Intrinsic Diode**

**Fig. 10. Capacitance**

**Fig. 11. Reverse-Bias Safe Operating Area**

**Fig. 12. Maximum Transient Thermal Impedance**

**Fig. 13. Resistive Turn-on Rise Time vs. Junction Temperature**

**Fig. 14. Resistive Turn-on Rise Time vs. Collector Current**

**Fig. 15. Resistive Turn-on Switching Times vs. Gate Resistance**

**Fig. 16. Resistive Turn-off Switching Times vs. Junction Temperature**

**Fig. 17. Resistive Turn-off Switching Times vs. Collector Current**

**Fig. 18. Resistive Turn-off Switching Times vs. Gate Resistance**

**Fig. 19. Forward-Bias Safe Operating Area @  $T_C = 25^\circ\text{C}$** 

**Fig. 20. Forward-Bias Safe Operating Area @  $T_C = 75^\circ\text{C}$** 

**TO-247PLUS-HV Outline**

SYM	INCHES		MILLIMETERS	
	MIN	MAX	MIN	MAX
A	.193	.201	4.90	5.10
A1	.114	.122	2.90	3.10
A2	.075	.083	1.90	2.10
A3	.035	.043	0.90	1.10
b	.053	.059	1.35	1.50
b1	.075	.083	1.90	2.10
c	.022	.030	0.55	0.75
D	.819	.843	20.80	21.40
D1	.638	.646	16.20	16.40
D2	.134	.146	3.40	3.70
D3	.055	.063	1.40	1.60
E	.622	.638	15.80	16.20
E1	.520	.528	13.20	13.40
E2	.118	.126	3.00	3.20
E3	.051	.059	1.30	1.50
e	.100 BSC		2.54 BSC	
e1	.300 BSC		7.62 BSC	
L	.732	.748	18.60	19.00
L1	.106	.118	2.70	3.00
Q	.216	.224	5.50	5.70
R	.165	.169	4.20	4.30



---

Disclaimer Notice - Information furnished is believed to be accurate and reliable. However, users should independently evaluate the suitability of and test each product selected for their own applications. Littelfuse products are not designed for, and may not be used in, all applications. Read complete Disclaimer Notice at [www.littelfuse.com/disclaimer-electronics](http://www.littelfuse.com/disclaimer-electronics).