

High Voltage, BiMOSFET™ Monolithic Bipolar MOS Transistor

IXBF42N300

$$V_{CES} = 3000V$$

$$I_{C110} = 24A$$

$$V_{CE(sat)} \leq 3.0V$$

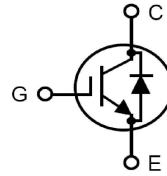

(Electrically Isolated Tab)

ISOPLUS i4-Pak™

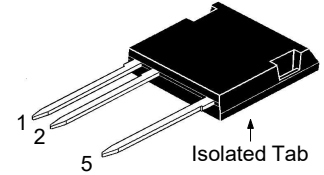

1 = Gate
2 = Emitter

5 = Collector

Symbol	Test Conditions	Maximum Ratings	
V_{CES}	$T_C = 25^\circ C$ to $150^\circ C$	3000	V
V_{CGR}	$T_J = 25^\circ C$ to $150^\circ C$, $R_{GE} = 1M\Omega$	3000	V
V_{GES}	Continuous	± 25	V
V_{GEM}	Transient	± 35	V
I_{C25}	$T_C = 25^\circ C$	60	A
I_{C110}	$T_C = 110^\circ C$	24	A
I_{CM}	$T_C = 25^\circ C$, 1ms	400	A
SSOA (RBSOA)	$V_{GE} = 15V$, $T_{VJ} = 125^\circ C$, $R_G = 20\Omega$	$I_{CM} = 84$	A
	Clamped Inductive Load	1500	V
T_{SC} (SCSOA)	$V_{GE} = 15V$, $T_J = 125^\circ C$, $R_G = 82\Omega$, $V_{CE} = 1500V$, Non-Repetitive	10	μs
P_C	$T_C = 25^\circ C$	240	W
T_J		-55 ... +150	$^\circ C$
T_{JM}		150	$^\circ C$
T_{stg}		-55 ... +150	$^\circ C$
T_L	Maximum Lead Temperature for Soldering 1.6 mm (0.062 in.) from Case for 10s	300	$^\circ C$
F_C	Mounting Force	20..120 / 4.5..27	N/lb
V_{ISOL}	50/60Hz, 1 Minute	3000	V~
Weight		5	g

Features

- Silicon Chip on Direct-Copper Bond (DCB) Substrate
- Isolated Mounting Surface
- 3000V~ Electrical Isolation
- High Blocking Voltage
- High Peak Current Capability
- Low Saturation Voltage
- FBSOA Rated
- SCSOA Rated

Advantages

- Low Gate Drive Requirement
- High Power Density

Applications

- Laser Generators
- Capacitor Discharge Circuits
- AC Switches
- Protection Circuits

Symbol	Test Conditions ($T_J = 25^\circ C$ Unless Otherwise Specified)	Characteristic Values		
		Min.	Typ.	Max.
BV_{CES}	$I_C = 1mA$, $V_{GE} = 0V$	3000		V
$V_{GE(th)}$	$I_C = 1mA$, $V_{CE} = V_{GE}$	3.0		5.0 V
I_{CES}	$V_{CE} = 0.8 \cdot V_{CES}$, $V_{GE} = 0V$ Note 2, $T_J = 125^\circ C$		250	50 μA
I_{GES}	$V_{CE} = 0V$, $V_{GE} = \pm 25V$			± 200 nA
$V_{CE(sat)}$	$I_C = 42A$, $V_{GE} = 15V$, Note 1 $T_J = 125^\circ C$		2.5	3.0 V
			3.1	V

Symbol Test Conditions ($T_J = 25^\circ\text{C}$ Unless Otherwise Specified)		Characteristic Values		
		Min.	Typ.	Max.
g_{fs}	$I_C = 42\text{A}, V_{CE} = 10\text{V}$, Note 1	28	45	S
C_{ies}	$V_{CE} = 25\text{V}, V_{GE} = 0\text{V}, f = 1\text{MHz}$		4780	pF
C_{oes}			170	pF
C_{res}			56	pF
R_{Gi}	Gate Input Resistance		3.0	Ω
Q_g	$I_C = 42\text{A}, V_{GE} = 15\text{V}, V_{CE} = 1000\text{V}$		200	nC
Q_{ge}			28	nC
Q_{gc}			75	nC
$t_{d(on)}$	Resistive Switching Times, $T_J = 25^\circ\text{C}$ $I_C = 42\text{A}, V_{GE} = 15\text{V}$ $V_{CE} = 1500\text{V}, R_G = 20\Omega$		72	ns
t_r			330	ns
$t_{d(off)}$			445	ns
t_f			610	ns
$t_{d(on)}$	Resistive Switching Times, $T_J = 125^\circ\text{C}$ $I_C = 42\text{A}, V_{GE} = 15\text{V}$ $V_{CE} = 1500\text{V}, R_G = 20\Omega$		72	ns
t_r			580	ns
$t_{d(off)}$			460	ns
t_f			490	ns
R_{thJC}				0.52 $^\circ\text{C/W}$
R_{thCS}		0.15		$^\circ\text{C/W}$

Reverse Diode

Symbol Test Conditions ($T_J = 25^\circ\text{C}$ Unless Otherwise Specified)		Characteristic Values		
		Min.	Typ.	Max.
V_F	$I_F = 42\text{A}, V_{GE} = 0\text{V}$, Note 1			2.5 V
t_{rr}	$I_F = 21\text{A}, V_{GE} = 0\text{V}, -di_F/dt = 100\text{A}/\mu\text{s}$ $V_R = 100\text{V}, V_{GE} = 0\text{V}$		1.7	μs
I_{RM}			43	A

Notes:

1. Pulse test, $t < 300\mu\text{s}$, duty cycle, $d < 2\%$.
2. Device must be heatsunk for high-temperature leakage current measurements to avoid thermal runaway.

Additional provisions for lead-to-lead isolation are required at $V_{CE} > 1250\text{V}$.

Littelfuse reserves the right to change limits, test conditions and dimensions.

LFMOSFETs and IGBTs are covered by one or more of the following U.S. patents:	4,835,592	4,931,844	5,049,961	5,237,481	6,162,665	6,404,065B1	6,683,344	6,727,585	7,005,734 B2	7,157,338B2
	4,860,072	5,017,508	5,063,307	5,381,025	6,259,123B1	6,534,343	6,710,405B2	6,759,692	7,063,975B2	
	4,881,106	5,034,796	5,187,117	5,486,715	6,306,728 B1	6,583,505	6,710,463	6,771,478 B2	7,071,537	

Fig. 1. Output Characteristics @ $T_J = 25^\circ\text{C}$

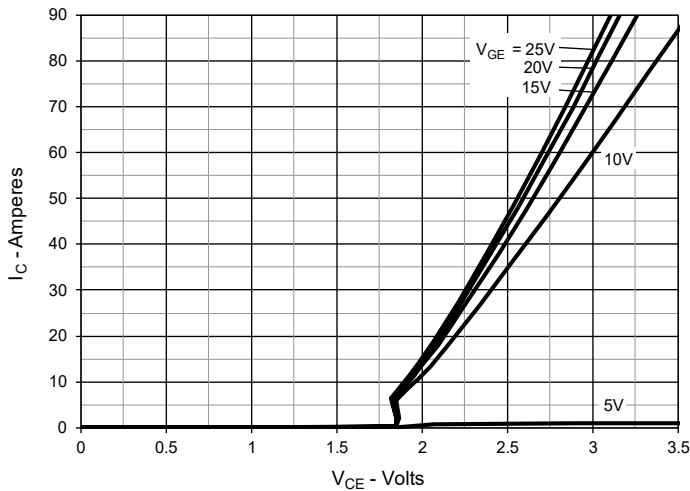

Fig. 2. Extended Output Characteristics @ $T_J = 25^\circ\text{C}$

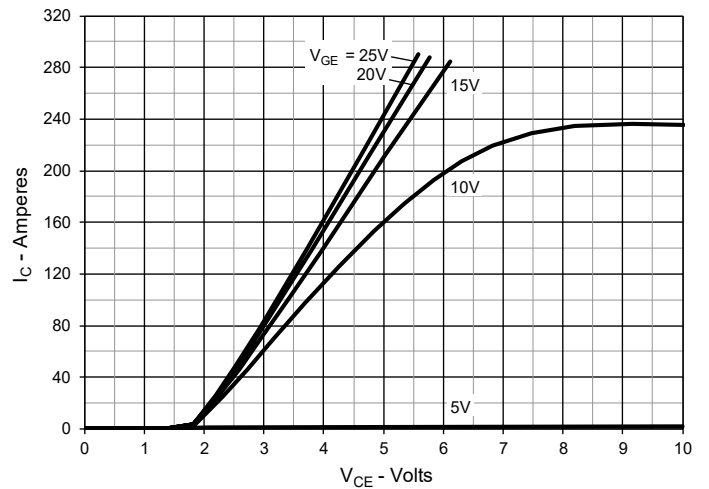

Fig. 3. Output Characteristics @ $T_J = 125^\circ\text{C}$

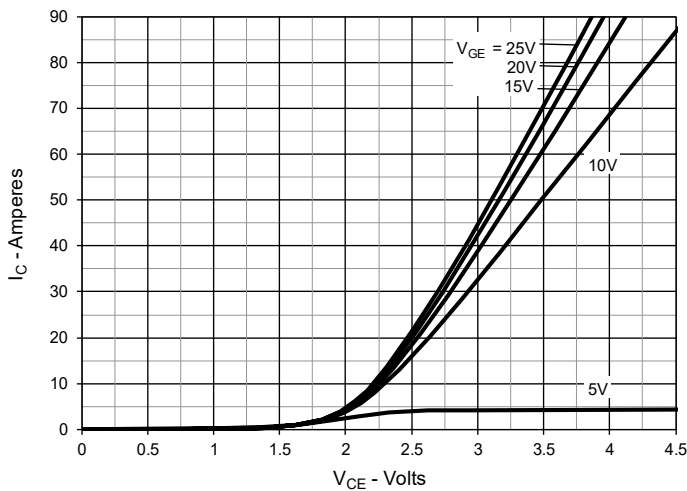

Fig. 4. Dependence of $V_{CE(sat)}$ on Junction Temperature

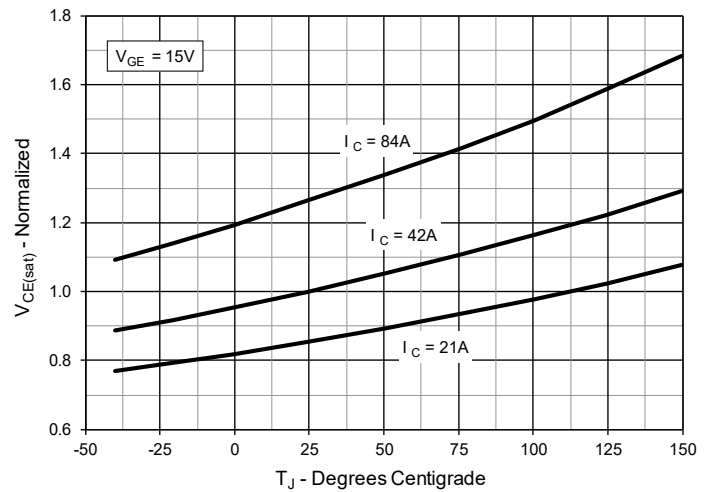

Fig. 5. Collector-to-Emitter Voltage vs. Gate-to-Emitter Voltage

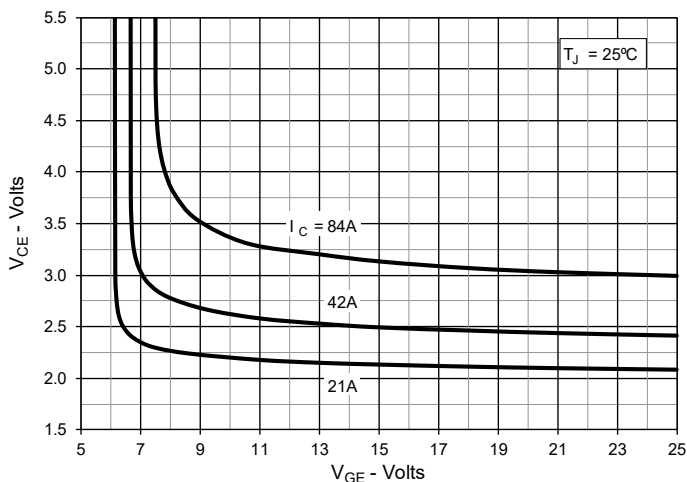

Fig. 6. Input Admittance

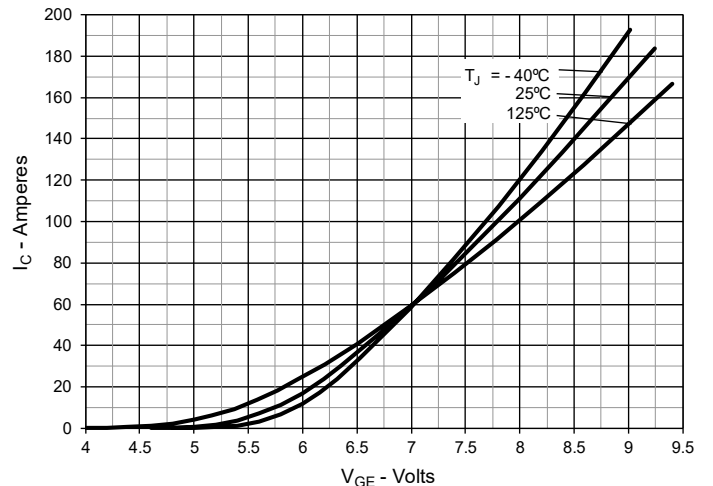

Fig. 7. Transconductance

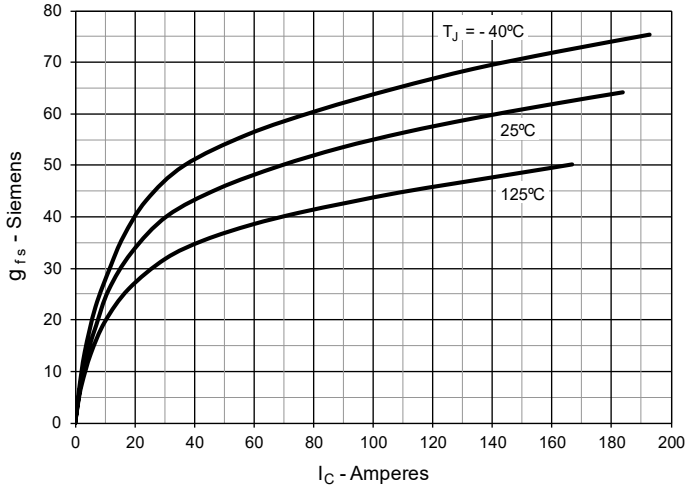

Fig. 8. Forward Voltage Drop of Intrinsic Diode

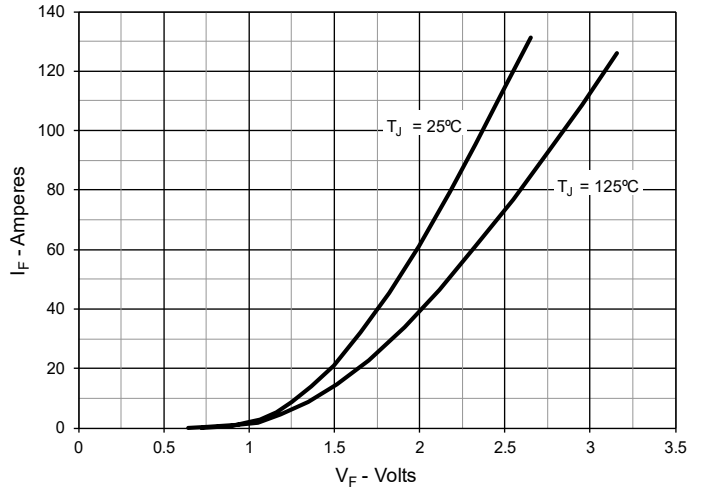

Fig. 9. Gate Charge

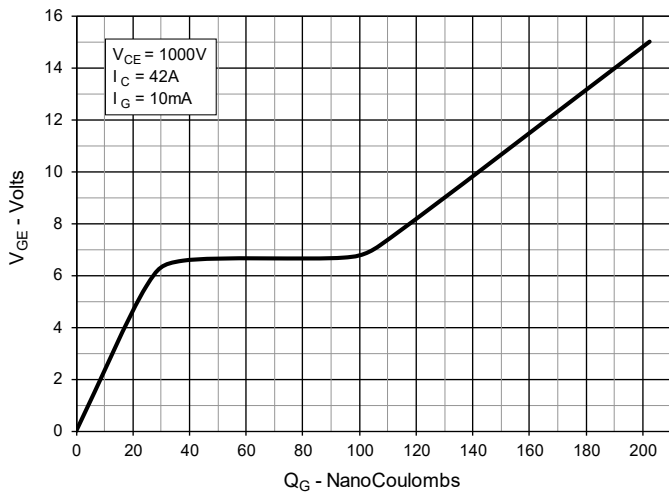

Fig. 10. Capacitance

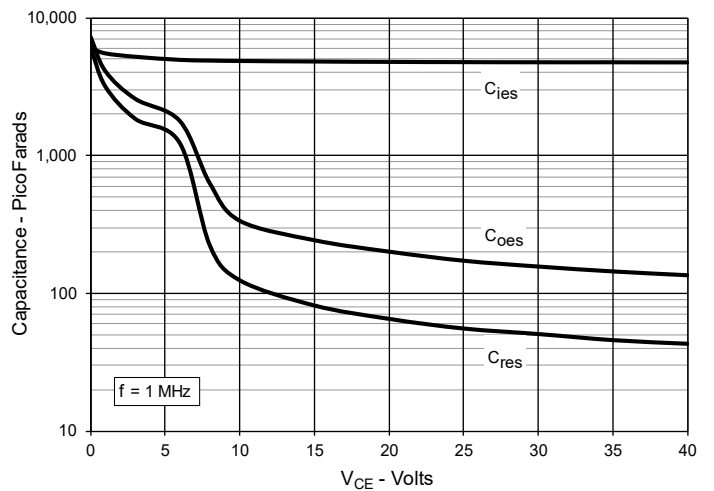

Fig. 11. Reverse-Bias Safe Operating Area

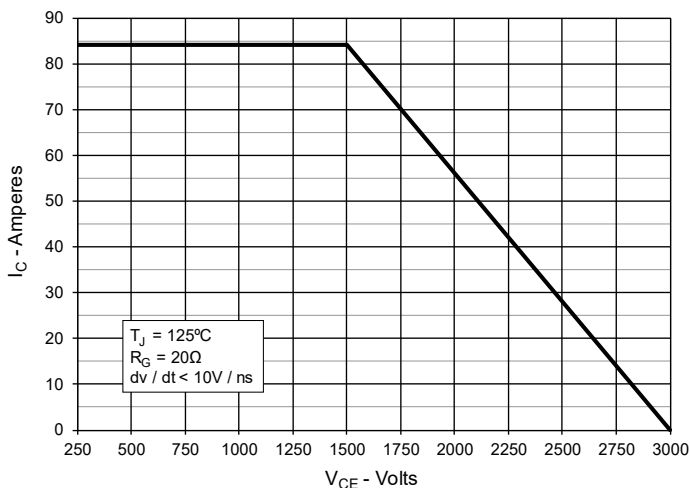

Fig. 12. Maximum Transient Thermal Impedance

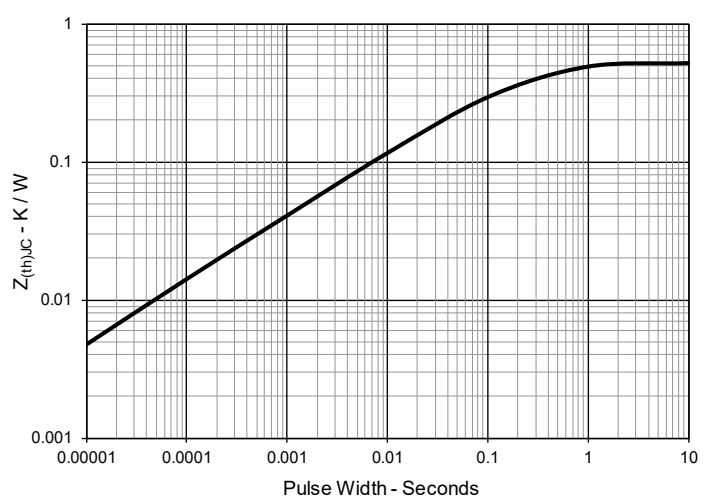

Fig. 13. Resistive Turn-on Rise Time vs. Junction Temperature

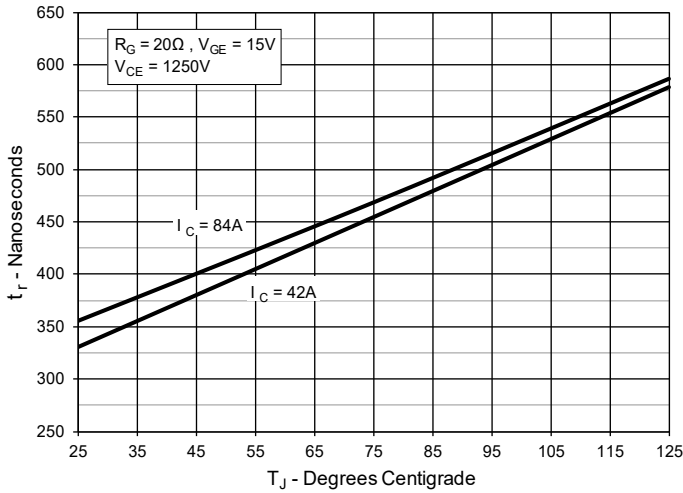

Fig. 14. Resistive Turn-on Rise Time vs. Collector Current

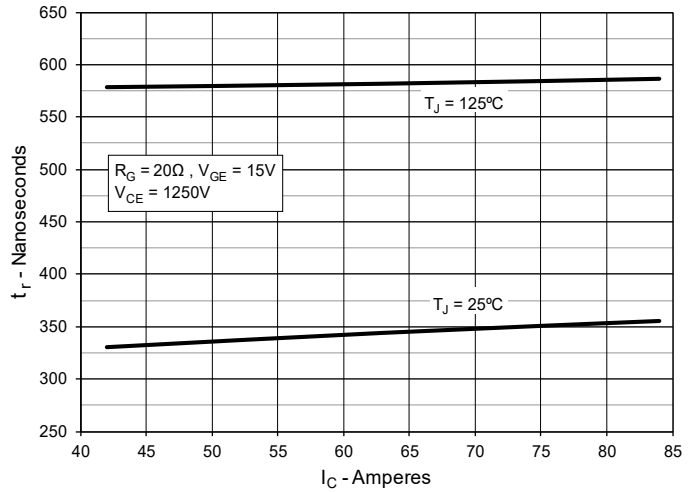

Fig. 15. Resistive Turn-on Switching Times vs. Gate Resistance

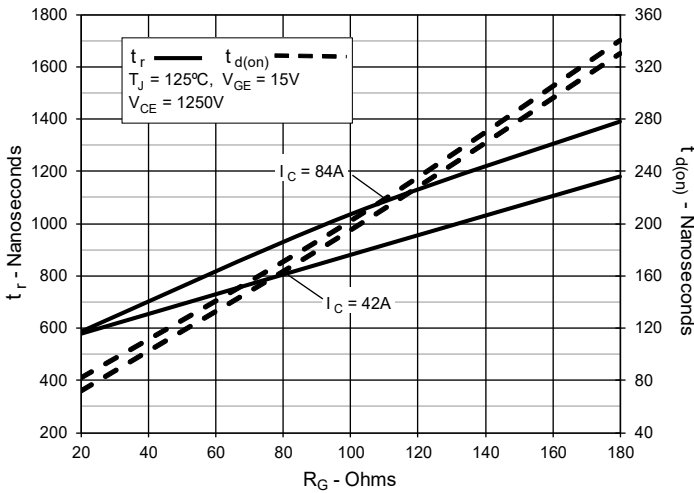

Fig. 16. Resistive Turn-off Switching Times vs. Junction Temperature

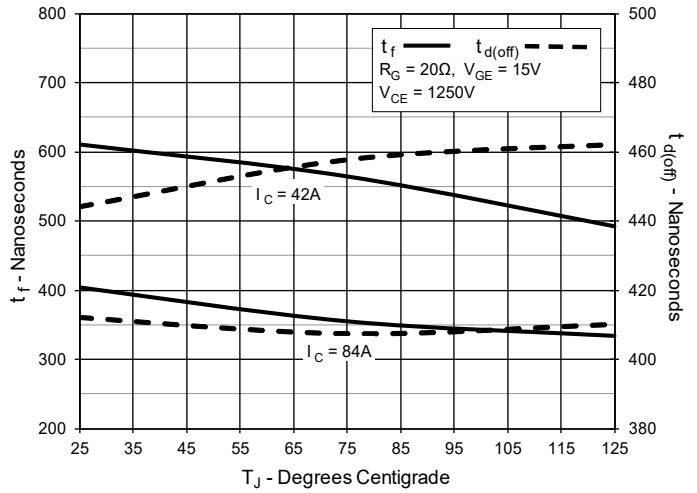

Fig. 17. Resistive Turn-off Switching Times vs. Collector Current

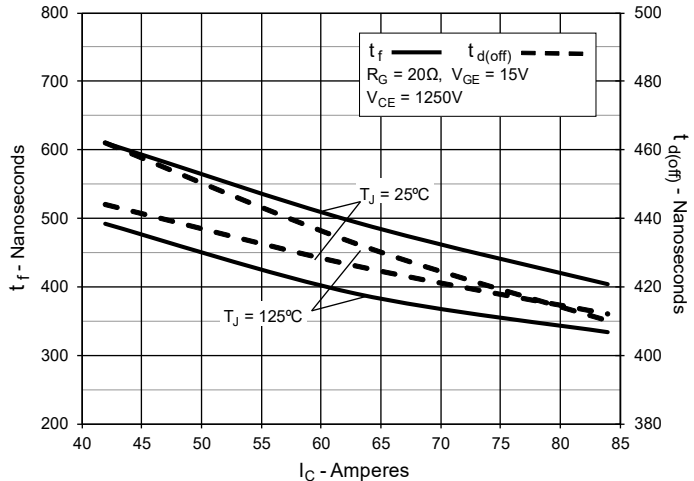

Fig. 18. Resistive Turn-off Switching Times vs. Gate Resistance

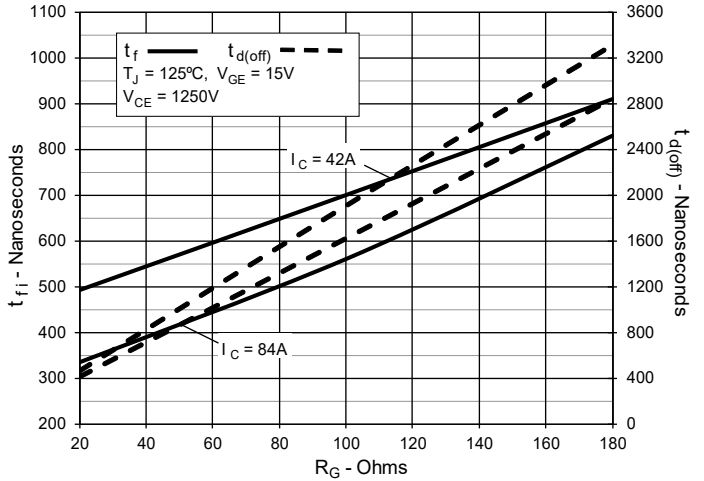

Fig. 19. Forward-Bias Safe Operating Area @ $T_C = 25^\circ\text{C}$

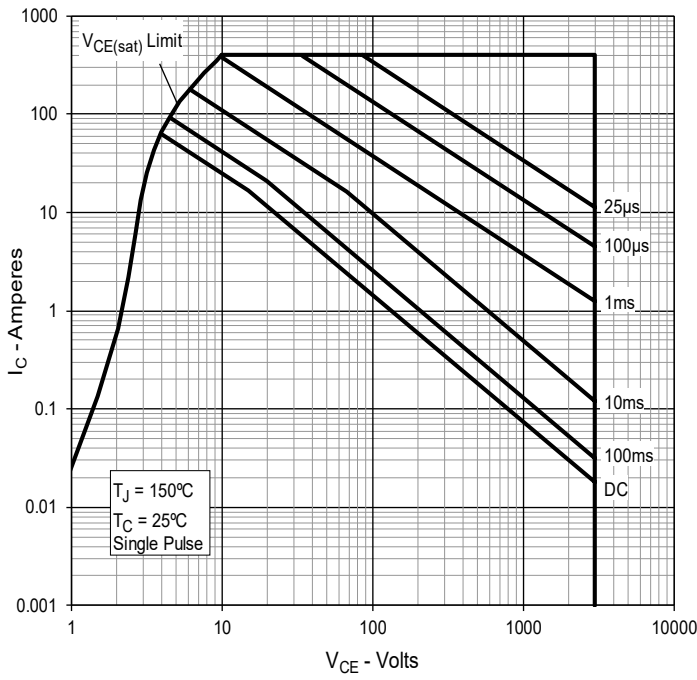
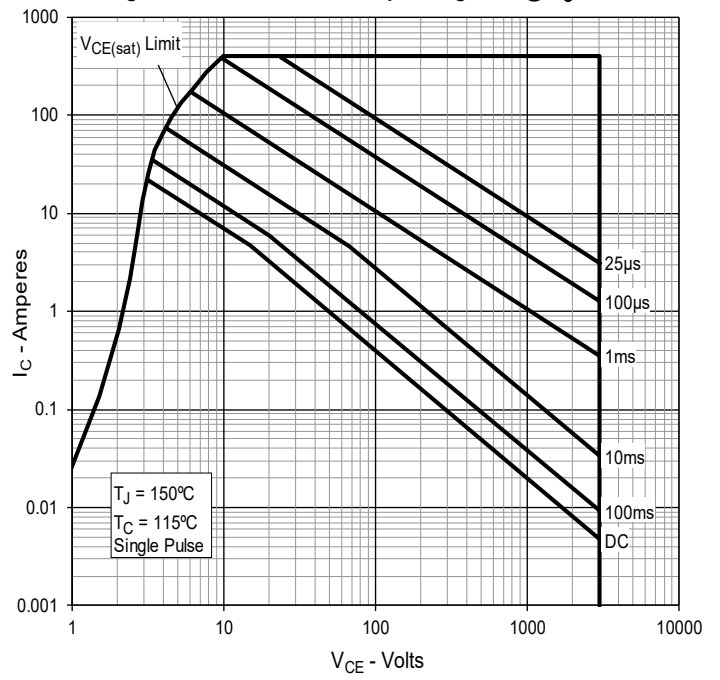
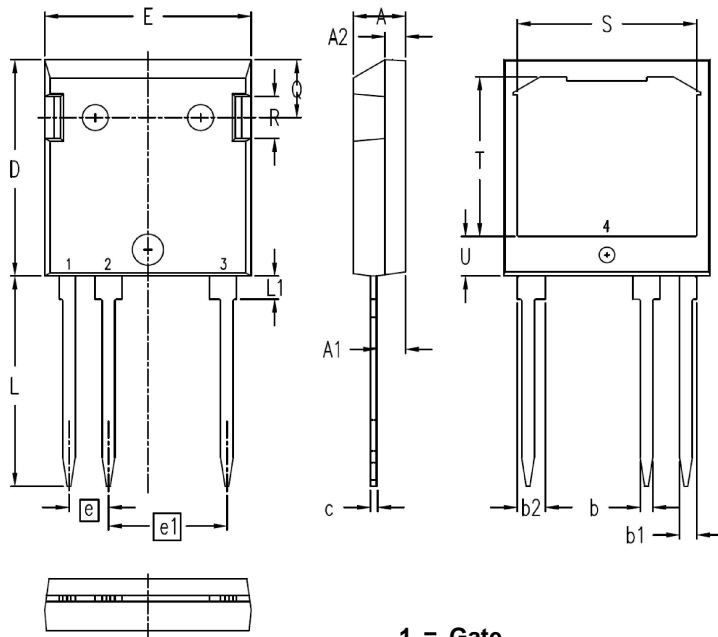

Fig. 20. Forward-Bias Safe Operating Area @ $T_C = 115^\circ\text{C}$



ISOPLUS i4-Pak Outline



1 = Gate
2 = Emitter
3,4 = Colector

SYM	INCHES		MILLIMETERS	
	MIN	MAX	MIN	MAX
A	.193	.201	4.90	5.10
A1	.106	.114	2.70	2.90
A2	.075	.083	1.90	2.10
b	.047	.055	1.20	1.40
b1	.061	.069	1.55	1.75
b2	.087	.094	2.20	2.40
c	.020	.029	0.51	0.74
D	.819	.846	20.80	21.50
E	.768	.799	19.50	20.30
e	.150 BSC		3.81 BSC	
e1	.450 BSC		11.43 BSC	
L	.780	.838	19.80	21.30
L1	.083	.094	2.10	2.40
Q	.213	.236	5.40	6.00
R	.157	.169	4.00	4.30
S	.673	.685	17.10	17.40
T	.602	.614	15.30	15.60
U	.142	.154	3.60	3.90