

High Voltage, High Gain BIMOSFET™ Monolithic Bipolar MOS Transistor

IXBA14N300HV IXBT14N300HV IXBH14N300HV

$V_{CES} = 3000V$
 $I_{C110} = 14A$
 $V_{CE(sat)} \leq 2.7V$

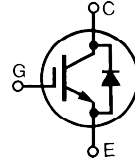

Symbol	Test Conditions	Maximum Ratings	
V_{CES}	$T_C = 25^\circ C$ to $150^\circ C$	3000	V
V_{CGR}	$T_J = 25^\circ C$ to $150^\circ C$, $R_{GE} = 1M\Omega$	3000	V
V_{GES}	Continuous	± 20	V
V_{GEM}	Transient	± 30	V
I_{C25}	$T_C = 25^\circ C$	38	A
I_{C110}	$T_C = 110^\circ C$	14	A
I_{CM}	$T_C = 25^\circ C$, 1ms	120	A
SSOA (RBSOA)	$V_{GE} = 15V$, $T_{VJ} = 125^\circ C$, $R_G = 20\Omega$ Clamped Inductive Load	$I_{CM} = 120$ 1500	A V
T_{SC} (SCSOA)	$V_{GE} = 15V$, $T_J = 125^\circ C$, $R_G = 82\Omega$, $V_{CE} = 1500V$, Non-Repetitive	10	μs
P_c	$T_C = 25^\circ C$	200	W
T_J		-55 ... +150	$^\circ C$
T_{JM}		150	$^\circ C$
T_{stg}		-55 ... +150	$^\circ C$
T_L	Maximum Lead Temperature for Soldering	300	$^\circ C$
T_{SOLD}	Plastic Body for 10s	260	$^\circ C$
F_c	Mounting Force (TO-263HV)	10..65 / 2.2..14.6	N/lb
M_d	Mounting Torque (TO-247HV)	1.13/10	Nm/lb.in
Weight	TO-263HV	2.5	g
	TO-268HV	4.0	g
	TO-247HV	6.0	g

TO-263HV
(IXBA..HV)

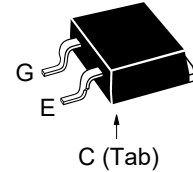

TO-268HV
(IXBT..HV)

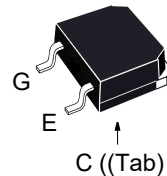

TO-247HV
(IXBH..HV)

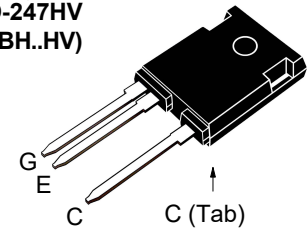

G = Gate C = Collector
E = Emitter Tab = Collector

Features

- High Voltage Packages
- High Blocking Voltage
- Anti-Parallel Diode
- Low Conduction Losses

Advantages

- Low Gate Drive Requirement
- High Power Density

Applications

- Switch-Mode and Resonant-Mode Power Supplies
- Uninterruptible Power Supplies (UPS)
- Laser Generators
- Capacitor Discharge Circuits
- AC Switches

Symbol	Test Conditions ($T_J = 25^\circ C$ Unless Otherwise Specified)	Characteristic Values		
		Min.	Typ.	Max.
BV_{CES}	$I_C = 250\mu A$, $V_{GE} = 0V$	3000		V
$V_{GE(th)}$	$I_C = 250\mu A$, $V_{CE} = V_{GE}$	3.0		V
I_{CES}	$V_{CE} = 0.8 \cdot V_{CES}$, $V_{GE} = 0V$ $T_J = 125^\circ C$			25 μA 750 μA
I_{GES}	$V_{CE} = 0V$, $V_{GE} = \pm 20V$			± 100 nA
$V_{CE(sat)}$	$I_C = 14A$, $V_{GE} = 15V$, Note 1 $T_J = 125^\circ C$		2.2 2.7	V V

Symbol Test Conditions ($T_J = 25^\circ\text{C}$ Unless Otherwise Specified)		Characteristic Values		
		Min.	Typ.	Max.
g_{fs}	$I_C = 14\text{A}, V_{CE} = 10\text{V}$, Note 1	8	13	S
C_{ies}	$V_{CE} = 25\text{V}, V_{GE} = 0\text{V}, f = 1\text{MHz}$		1275	pF
C_{oes}			50	pF
C_{res}			18	pF
Q_g	$I_C = 14\text{A}, V_{GE} = 15\text{V}, V_{CE} = 1500\text{V}$		62	nC
Q_{ge}			7	nC
Q_{gc}			30	nC
$t_{d(on)}$	Resistive Switching Times, $T_J = 25^\circ\text{C}$ $I_C = 14\text{A}, V_{GE} = 15\text{V}$ $V_{CE} = 960\text{V}, R_G = 20\Omega$		40	ns
t_r			380	ns
$t_{d(off)}$			166	ns
t_f			1900	ns
$t_{d(on)}$	Resistive Switching Times, $T_J = 125^\circ\text{C}$ $I_C = 14\text{A}, V_{GE} = 15\text{V}$ $V_{CE} = 960\text{V}, R_G = 20\Omega$		64	ns
t_r			746	ns
$t_{d(off)}$			180	ns
t_f			1730	ns
R_{thJC}				0.62 °C/W
R_{thCS}	TO-247HV		0.21	°C/W

Reverse Diode

Symbol Test Conditions ($T_J = 25^\circ\text{C}$ Unless Otherwise Specified)		Characteristic Values		
		Min.	Typ.	Max.
V_F	$I_F = 14\text{A}, V_{GE} = 0\text{V}$			2.7 V
t_{rr}	$I_F = 7\text{A}, V_{GE} = 0\text{V}, -di_F/dt = 100\text{A}/\mu\text{s}$		1.4	μs
I_{RM}			23	A
Q_{RM}	$V_R = 100\text{V}, V_{GE} = 0\text{V}$		16	μC

Note 1: Pulse test, $t \leq 300\mu\text{s}$, duty cycle, $d \leq 2\%$.

Littelfuse reserves the right to change limits, test conditions and dimensions.

IXYS MOSFETs and IGBTs are covered	4,835,592	4,931,844	5,049,961	5,237,481	6,162,665	6,404,065 B1	6,683,344	6,727,585	7,005,734 B2	7,157,338B2
by one or more of the following U.S. patents:	4,860,072	5,017,508	5,063,307	5,381,025	6,259,123 B1	6,534,343	6,710,405 B2	6,759,692	7,063,975 B2	
	4,881,106	5,034,796	5,187,117	5,486,715	6,306,728 B1	6,583,505	6,710,463	6,771,478 B2	7,071,537	

Fig. 1. Output Characteristics @ $T_J = 25^\circ\text{C}$

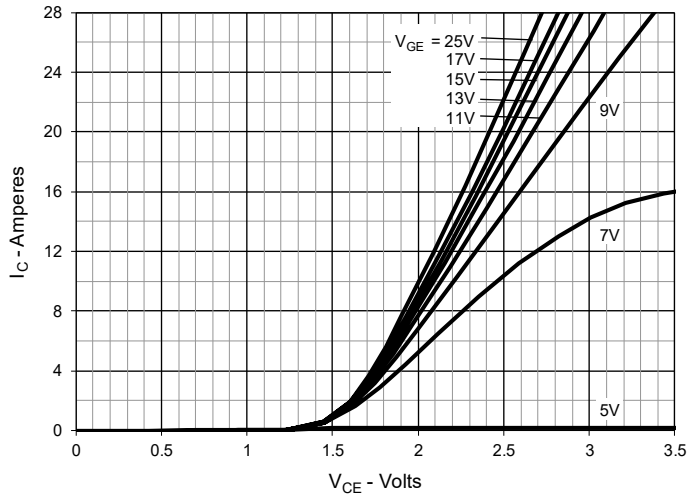

Fig. 2. Extended Output Characteristics @ $T_J = 25^\circ\text{C}$

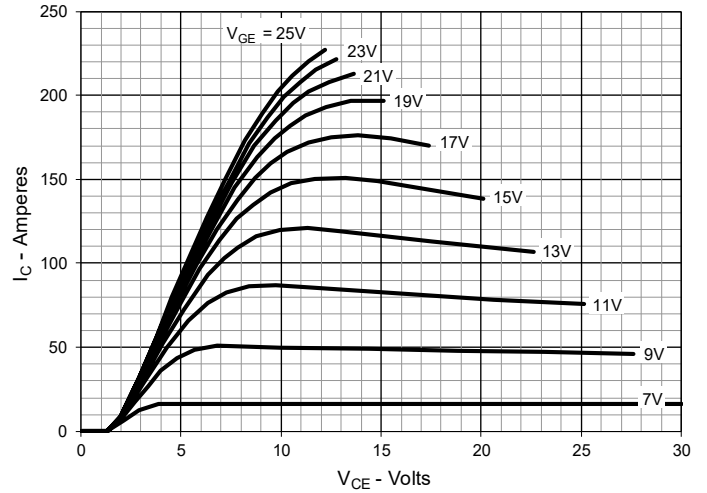

Fig. 3. Output Characteristics @ $T_J = 125^\circ\text{C}$

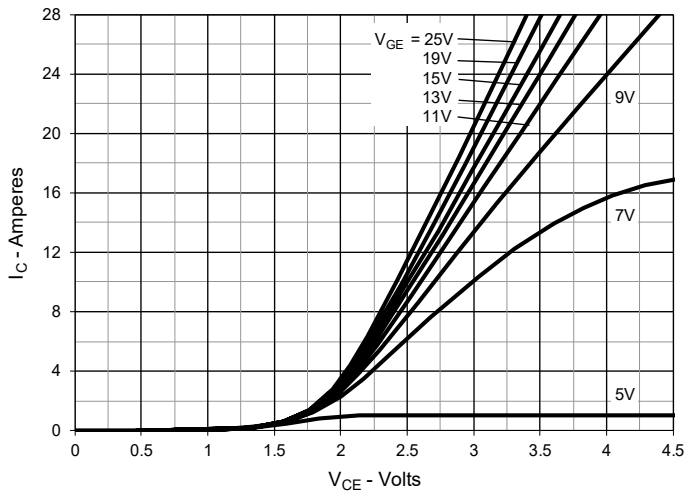

Fig. 4. Dependence of $V_{CE(sat)}$ on Junction Temperature

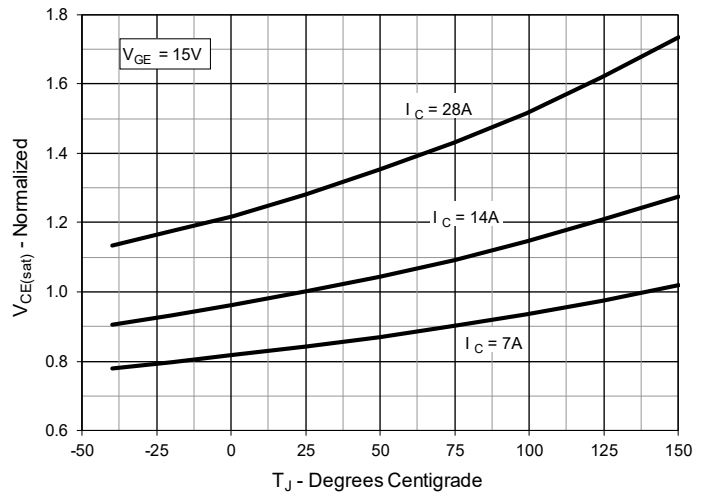

Fig. 5. Collector-to-Emitter Voltage vs. Gate-to-Emitter Voltage

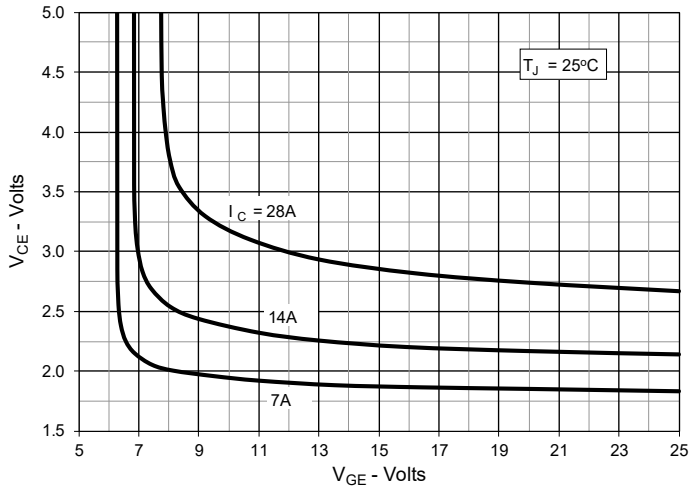

Fig. 6. Input Admittance

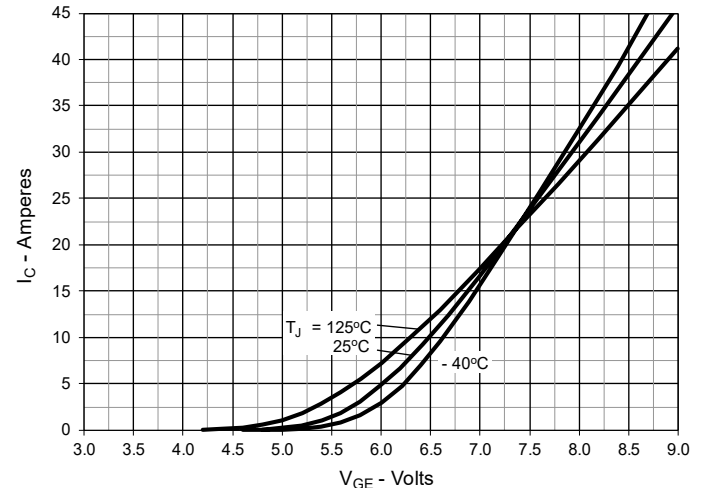

Fig. 7. Transconductance

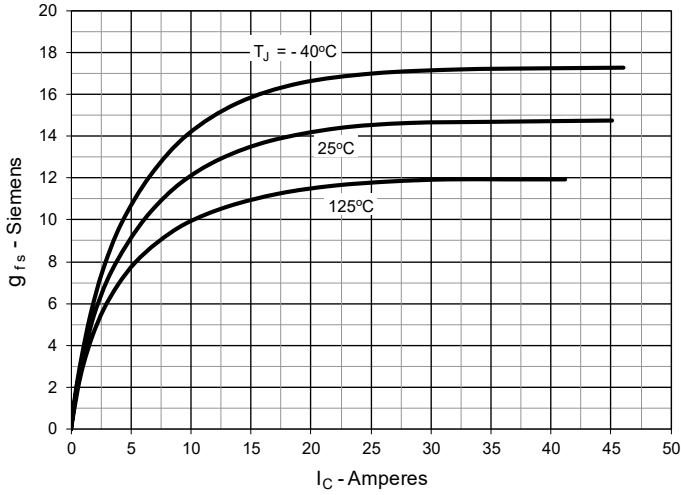

Fig. 8. Forward Voltage Drop of Intrinsic Diode

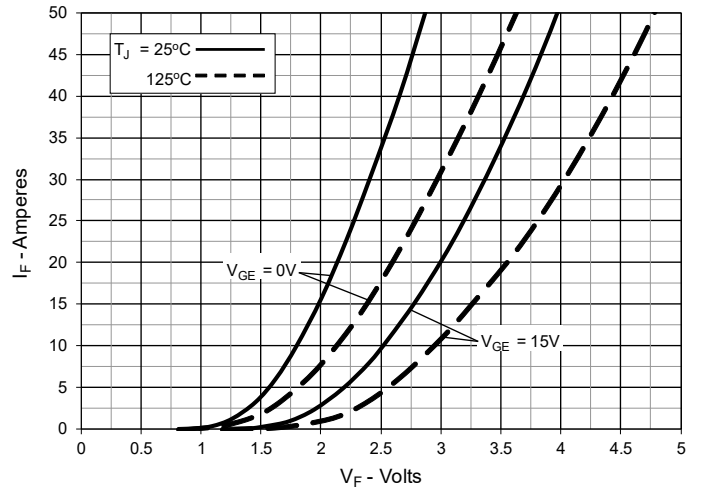

Fig. 9. Gate Charge

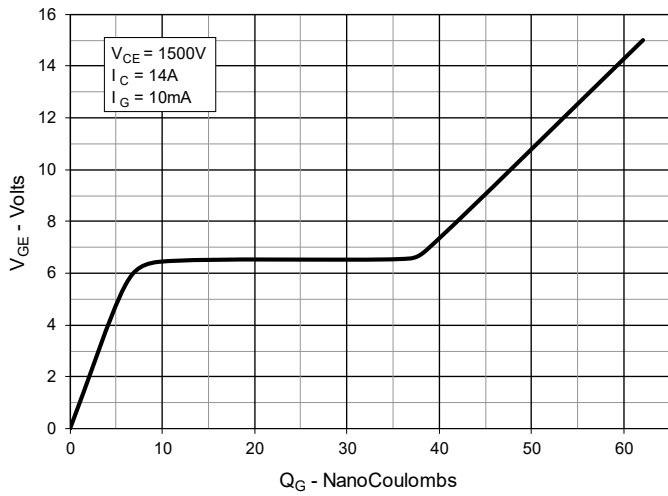

Fig. 10. Capacitance

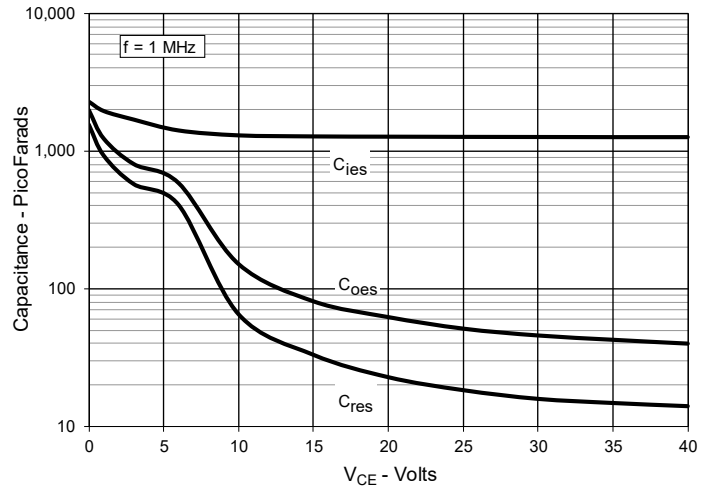

Fig. 11. Reverse-Bias Safe Operating Area

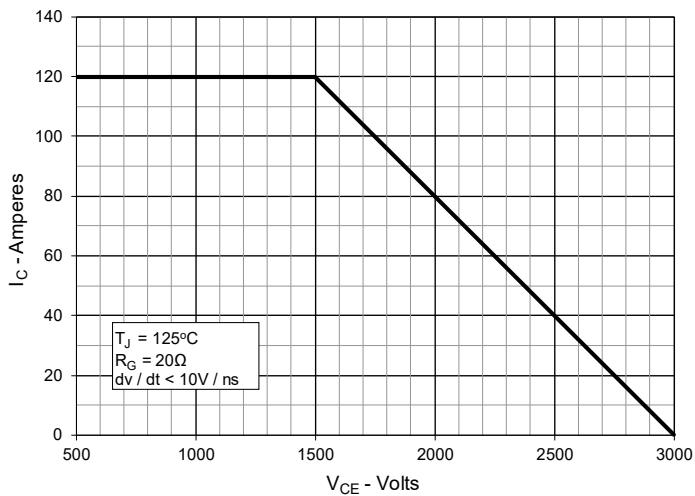
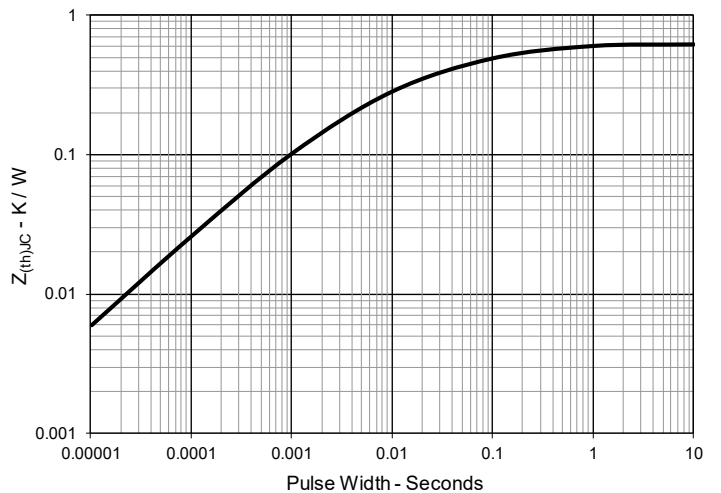
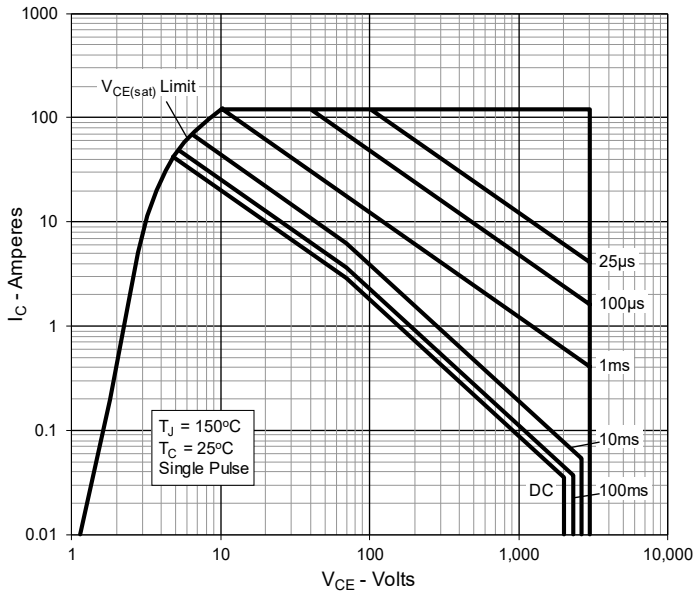

Fig. 12. Maximum Transient Thermal Impedance



**Fig. 13. Forward-Bias Safe Operating Area
@ $T_C = 25^\circ\text{C}$**



**Fig. 14. Forward-Bias Safe Operating Area
@ $T_C = 75^\circ\text{C}$**

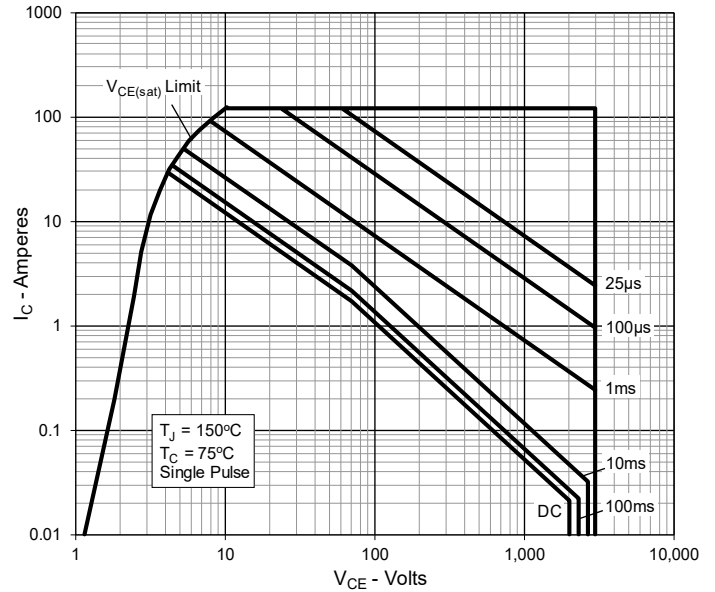

TO-263HV Outline

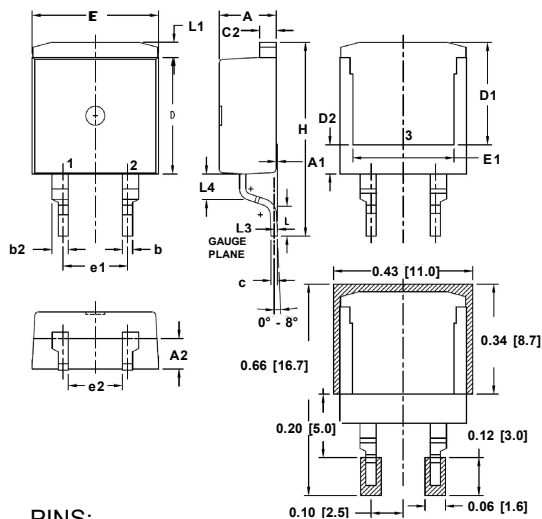

PINS:

- 1 - Gate 2 - Emitter
- 3 - Collector

SYM	INCHES		MILLIMETER	
	MIN	MAX	MIN	MAX
A	.170	.185	4.30	4.70
A1	.000	.008	0.00	0.20
A2	.091	.098	2.30	2.50
b	.028	.035	0.70	0.90
b2	.046	.054	1.18	1.38
C	.018	.024	0.45	0.60
C2	.049	.055	1.25	1.40
D	.354	.370	9.00	9.40
D1	.311	.327	7.90	8.30
D2	.083	.098	2.10	2.50
E	.386	.402	9.80	10.20
E1	.307	.323	7.80	8.20
e1	.200	BSC	5.08	BSC
(e2)	.163	.174	4.13	4.43
H	.591	.614	15.00	15.60
L	.079	.102	2.00	2.60
L1	.039	.055	1.00	1.40
L3	.010	BSC	0.254	BSC
(L4)	.071	.087	1.80	2.20

TO-268HV

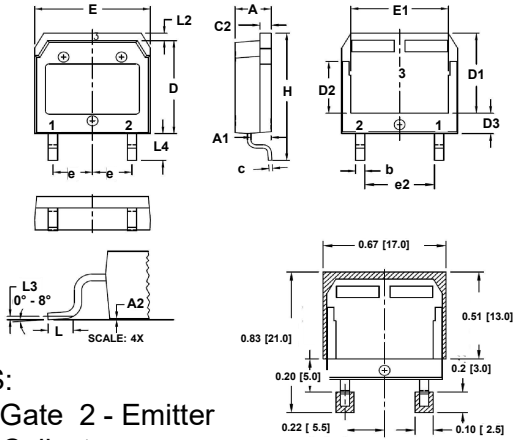

PINS:

- 1 - Gate 2 - Emitter
- 3 - Collector

SYM	INCHES		MILLIMETER	
	MIN	MAX	MIN	MAX
A	.193	.201	4.90	5.10
A1	.106	.114	2.70	2.90
A2	.001	.010	0.02	0.25
b	.045	.057	1.15	1.45
C	.016	.026	0.40	0.65
C2	.057	.063	1.45	1.60
D	.543	.551	13.80	14.00
D1	.465	.476	11.80	12.10
D2	.295	.307	7.50	7.80
D3	.114	.126	2.90	3.20
E	.624	.632	15.85	16.05
E1	.524	.535	13.30	13.60
e	.215	BSC	5.45	BSC
(e2)	.374	.386	9.50	9.80
H	.736	.752	18.70	19.10
L	.067	.079	1.70	2.00
L2	.039	.045	1.00	1.15
L3	.010	BSC	0.25	BSC
L4	.150	.161	3.80	4.10

TO-247HV

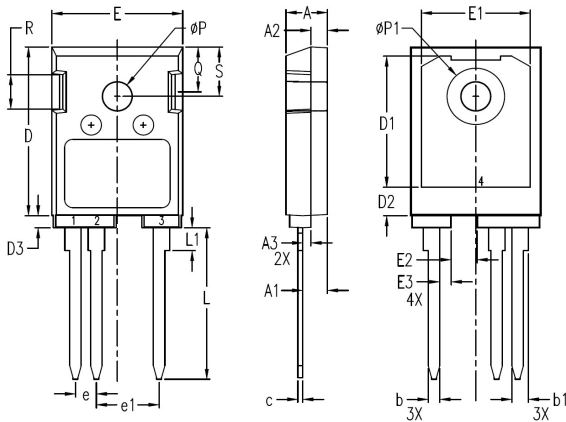

PINS:

- 1 - Gate 2 - Emitter
- 3,4 - Collector

SYM	INCHES		MILLIMETERS	
	MIN	MAX	MIN	MAX
A	.193	.201	4.90	5.10
A1	.114	.122	2.90	3.10
A2	.075	.083	1.90	2.10
A3	.035	.043	0.90	1.10
b	.053	.059	1.35	1.50
b1	.075	.083	1.90	2.10
c	.022	.030	0.55	0.75
D	.819	.843	20.80	21.40
D1	.638	.646	16.20	16.40
D2	.134	.146	3.40	3.70
D3	.055	.063	1.40	1.60
E	.622	.638	15.80	16.20
E1	.520	.528	13.20	13.40
E2	.118	.126	3.00	3.20
E3	.051	.059	1.30	1.50
e	.100	BSC	2.54	BSC
e1	.300	BSC	7.62	BSC
L	.724	.748	18.40	19.00
L1	.106	.118	2.70	3.00
øP	.138	.142	3.50	3.60
øP1	.272	.280	6.90	7.10
Q	.216	.224	5.50	5.70
R	.165	.169	4.20	4.30
S	.240	.248	6.10	6.30



Disclaimer Notice - Information furnished is believed to be accurate and reliable. However, users should independently evaluate the suitability of and test each product selected for their own applications. Littelfuse products are not designed for, and may not be used in, all applications. Read complete Disclaimer Notice at www.littelfuse.com/disclaimer-electronics.
