

**High Voltage, High Gain  
BIMOSFET™ Monolithic  
Bipolar MOS Transistor**

**IXBT12N300  
IXBH12N300**

$V_{CES} = 3000V$   
 $I_{C110} = 12A$   
 $V_{CE(sat)} \leq 3.2V$

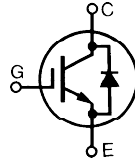

**TO-268  
(IXBT)**

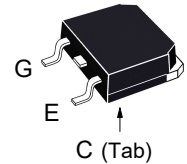

**TO-247  
(IXBH)**

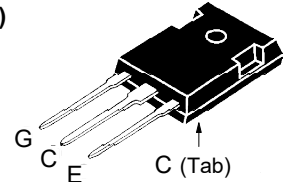

G = Gate      C = Collector  
E = Emitter    Tab = Collector

Symbol	Test Conditions	Maximum Ratings	
$V_{CES}$	$T_C = 25^\circ C$ to $150^\circ C$	3000	V
$V_{CGR}$	$T_J = 25^\circ C$ to $150^\circ C$ , $R_{GE} = 1M\Omega$	3000	V
$V_{GES}$	Continuous	$\pm 20$	V
$V_{GEM}$	Transient	$\pm 30$	V
$I_{C25}$	$T_C = 25^\circ C$	30	A
$I_{C110}$	$T_C = 110^\circ C$	12	A
$I_{CM}$	$T_C = 25^\circ C$ , 1ms	100	A
<b>SSOA (RBSOA)</b>	$V_{GE} = 15V$ , $T_{VJ} = 125^\circ C$ , $R_G = 30\Omega$ Clamped Inductive Load	$I_{CM} = 98$ 1500	A V
$P_C$	$T_C = 25^\circ C$	160	W
$T_J$		-55 ... +150	$^\circ C$
$T_{JM}$		150	$^\circ C$
$T_{stg}$		-55 ... +150	$^\circ C$
$T_L$	Maximum Lead Temperature for Soldering	300	$^\circ C$
$T_{SOLD}$	Plastic Body for 10s	260	$^\circ C$
$M_d$	Mounting Torque (TO-247)	1.13/10	Nm/lb.in.
<b>Weight</b>	TO-268	4	g
	TO-247	6	g

**Features**

- High Blocking Voltage
- International Standard Packages
- Anti-Parallel Diode
- Low Conduction Losses

**Advantages**

- Low Gate Drive Requirement
- High Power Density

**Applications:**

- Switched-Mode and Resonant-Mode Power Supplies
- Uninterruptible Power Supplies (UPS)
- Laser Generators
- Capacitor Discharge Circuits
- AC Switches

Symbol	Test Conditions ( $T_J = 25^\circ C$ Unless Otherwise Specified)	Characteristic Values		
		Min.	Typ.	Max.
$BV_{CES}$	$I_C = 250\mu A$ , $V_{GE} = 0V$	3000		V
$V_{GE(th)}$	$I_C = 250\mu A$ , $V_{CE} = V_{GE}$	3.0		V
$I_{CES}$	$V_{CE} = 0.8 \cdot V_{CES}$ , $V_{GE} = 0V$ $T_J = 125^\circ C$			25 $\mu A$ 1 mA
$I_{GES}$	$V_{CE} = 0V$ , $V_{GE} = \pm 20V$			$\pm 100$ nA
$V_{CE(sat)}$	$I_C = 12A$ , $V_{GE} = 15V$ , Note 1 $T_J = 125^\circ C$		2.8	3.2 V
			3.5	V

Symbol Test Conditions ( $T_J = 25^\circ\text{C}$ Unless Otherwise Specified)		Characteristic Values		
		Min.	Typ.	Max.
$g_{fs}$	$I_C = 12\text{A}, V_{CE} = 10\text{V}$ , Note 1	6.5	10.8	S
$C_{ies}$	$V_{CE} = 25\text{V}, V_{GE} = 0\text{V}, f = 1\text{MHz}$		1290	pF
$C_{oes}$			56	pF
$C_{res}$			19	pF
$Q_g$	$I_C = 12\text{A}, V_{GE} = 15\text{V}, V_{CE} = 1000\text{V}$		62	nC
$Q_{ge}$			13	nC
$Q_{gc}$			8.5	nC
$t_{d(on)}$	<b>Resistive Switching Times, <math>T_J = 25^\circ\text{C}</math></b> $I_C = 12\text{A}, V_{GE} = 15\text{V}$ $V_{CE} = 1250\text{V}, R_G = 10\Omega$		64	ns
$t_r$			140	ns
$t_{d(off)}$			180	ns
$t_f$			540	ns
$t_{d(on)}$	<b>Resistive Switching Times, <math>T_J = 125^\circ\text{C}</math></b> $I_C = 12\text{A}, V_{GE} = 15\text{V}$ $V_{CE} = 1250\text{V}, R_G = 10\Omega$		65	ns
$t_r$			395	ns
$t_{d(off)}$			175	ns
$t_f$			530	ns
$R_{thJC}$	TO-247		0.78	$^\circ\text{C/W}$
$R_{thCS}$		0.21		$^\circ\text{C/W}$

## Reverse Diode

Symbol Test Conditions ( $T_J = 25^\circ\text{C}$ Unless Otherwise Specified)		Characteristic Values		
		Min.	Typ.	Max.
$V_F$	$I_F = 12\text{A}, V_{GE} = 0\text{V}$			2.1 V
$t_{rr}$	$I_F = 6\text{A}, V_{GE} = 0\text{V}, -di_F/dt = 100\text{A}/\mu\text{s}$		1.4	$\mu\text{s}$
$I_{RM}$		$V_R = 100\text{V}, V_{GE} = 0\text{V}$		21

Note 1: Pulse test,  $t \leq 300\mu\text{s}$ , duty cycle,  $d \leq 2\%$ .

Littelfuse reserves the right to change limits, test conditions and dimensions.

IXYS MOSFETs and IGBTs are covered by one or more of the following U.S. patents:

4,835,592	4,931,844	5,049,961	5,237,481	6,162,665	6,404,065 B1	6,683,344	6,727,585	7,005,734 B2	7,157,338B2
4,860,072	5,017,508	5,063,307	5,381,025	6,259,123 B1	6,534,343	6,710,405 B2	6,759,692	7,063,975 B2	
4,881,106	5,034,796	5,187,117	5,486,715	6,306,728 B1	6,583,505	6,710,463	6,771,478 B2	7,071,537	

Fig. 1. Output Characteristics @  $T_J = 25^\circ\text{C}$

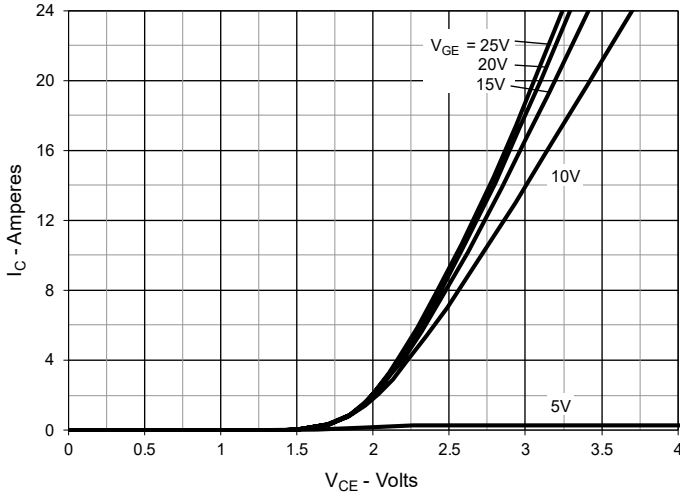

Fig. 2. Extended Output Characteristics @  $T_J = 25^\circ\text{C}$

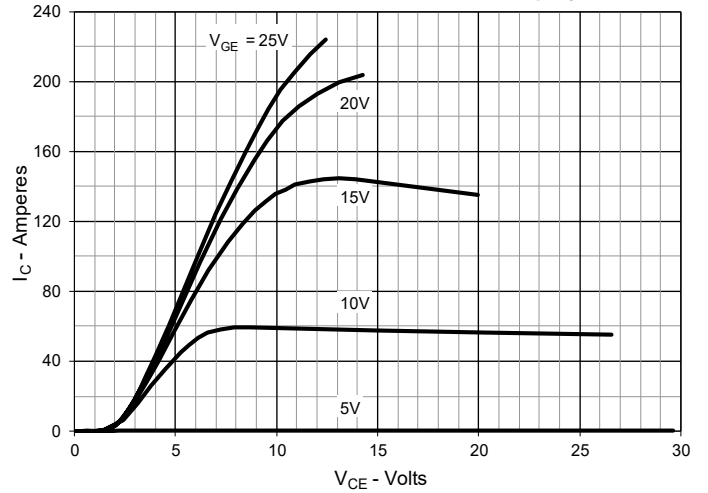

Fig. 3. Output Characteristics @  $T_J = 125^\circ\text{C}$

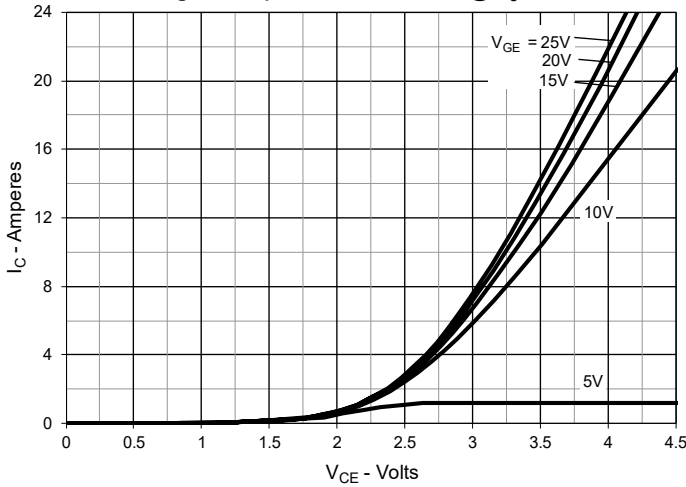

Fig. 4. Dependence of  $V_{CE(sat)}$  on Junction Temperature

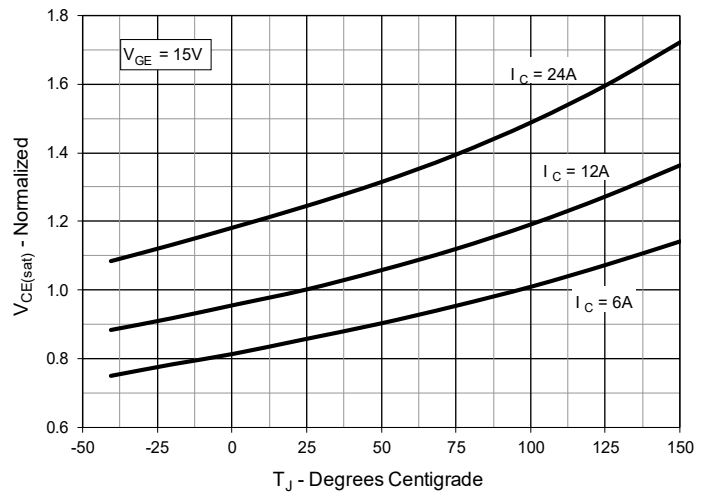

Fig. 5. Collector-to-Emitter Voltage vs. Gate-to-Emitter Voltage

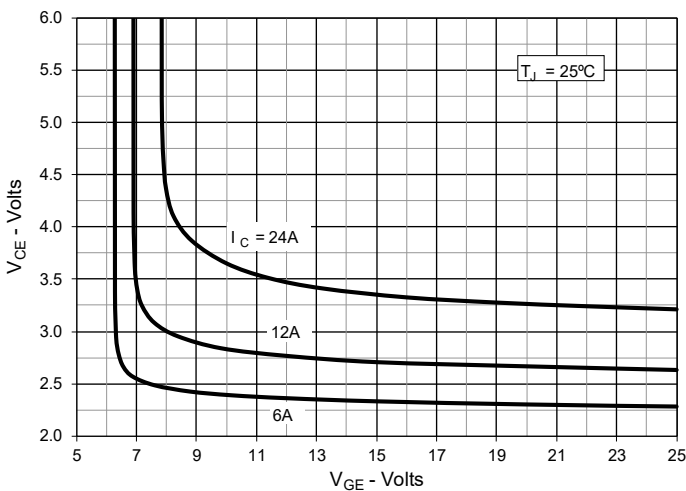

Fig. 6. Input Admittance

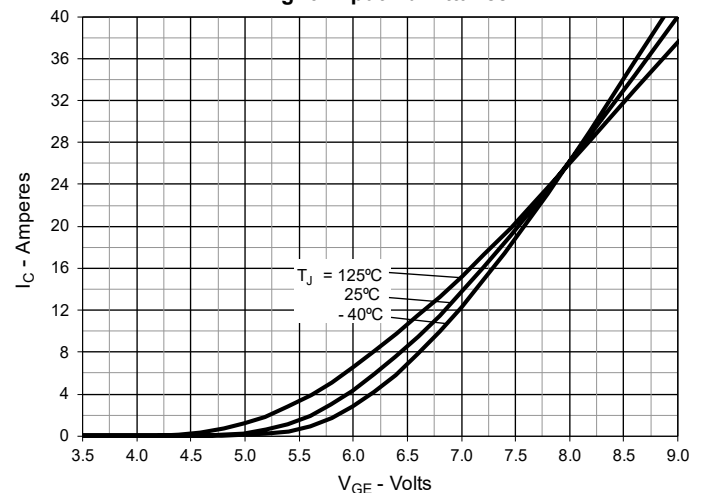

Fig. 7. Transconductance

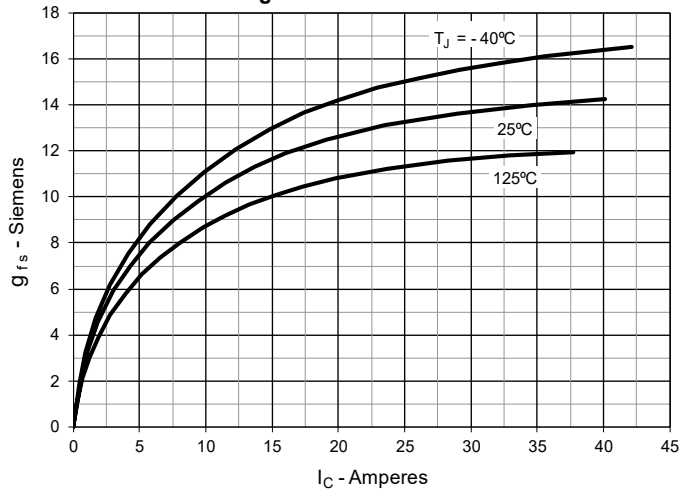

Fig. 8. Forward Voltage Drop of Intrinsic Diode

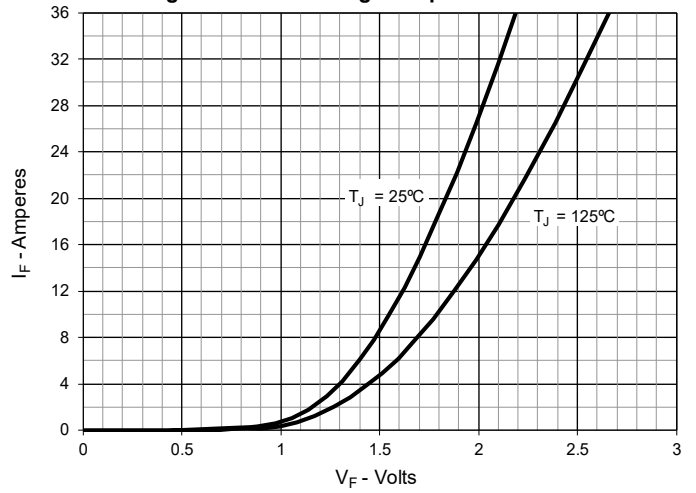

Fig. 9. Gate Charge

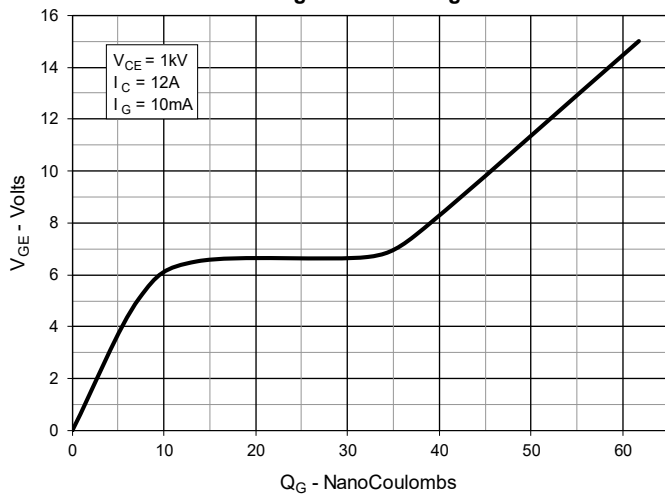

Fig. 10. Capacitance

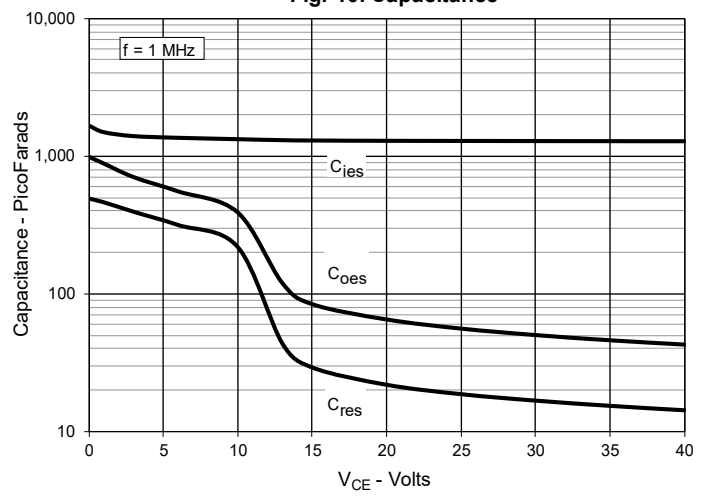

Fig. 11. Reverse-Bias Safe Operating Area

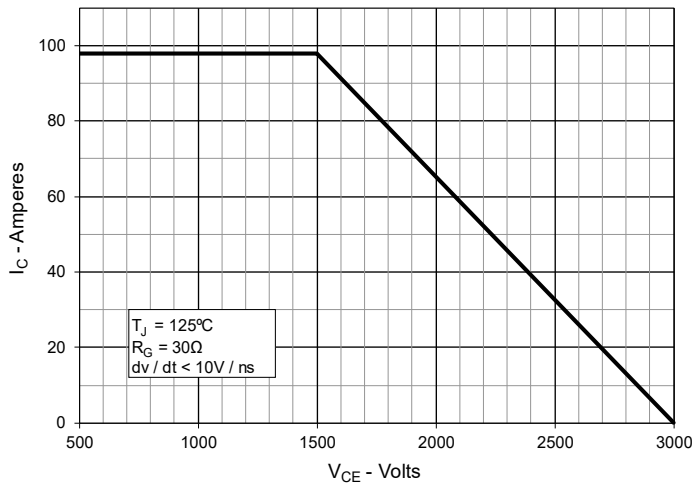
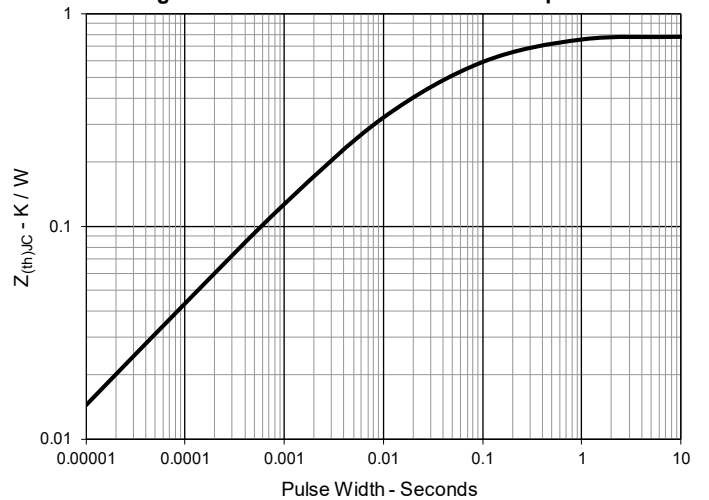
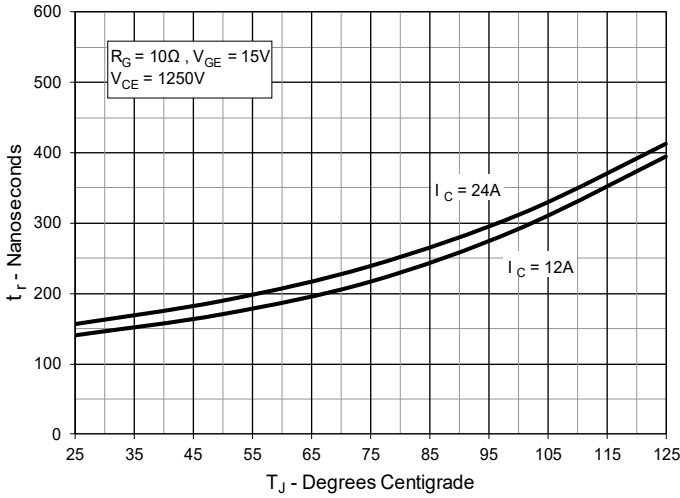

Fig. 12. Maximum Transient Thermal Impedance



**Fig. 15. Resistive Turn-on Rise Time vs. Junction Temperature**



**Fig. 16. Resistive Turn-on Rise Time vs. Collector Current**



**Fig. 17. Resistive Turn-off Switching Times vs. Gate Resistance**

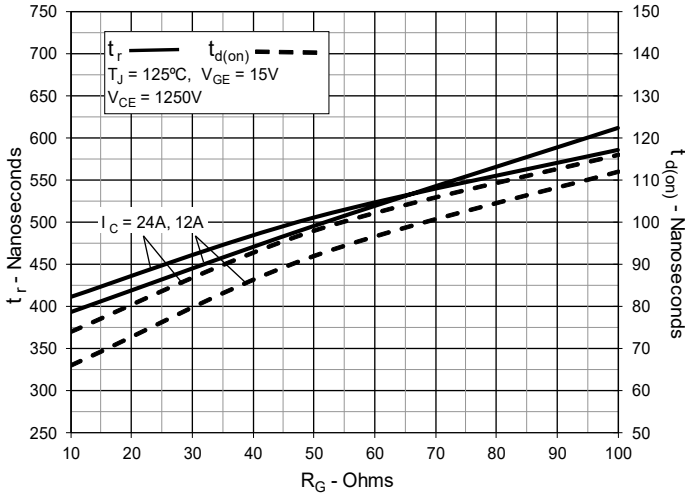

**Fig. 18. Resistive Turn-off Switching Times vs. Junction Temperature**

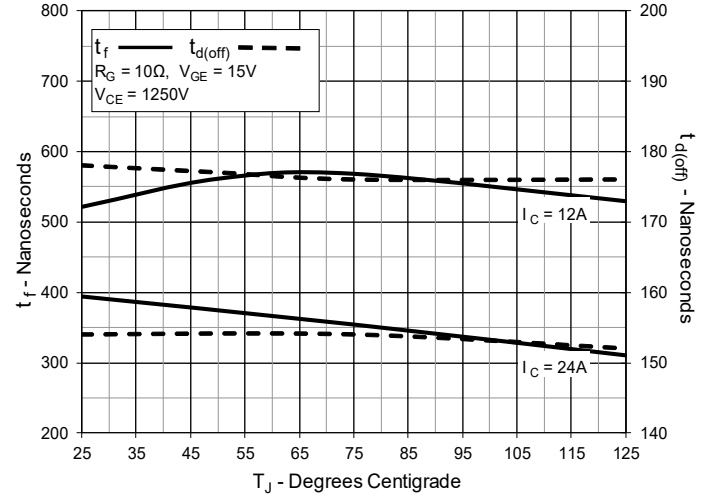

**Fig. 19. Resistive Turn-off Switching Times vs. Collector Current**

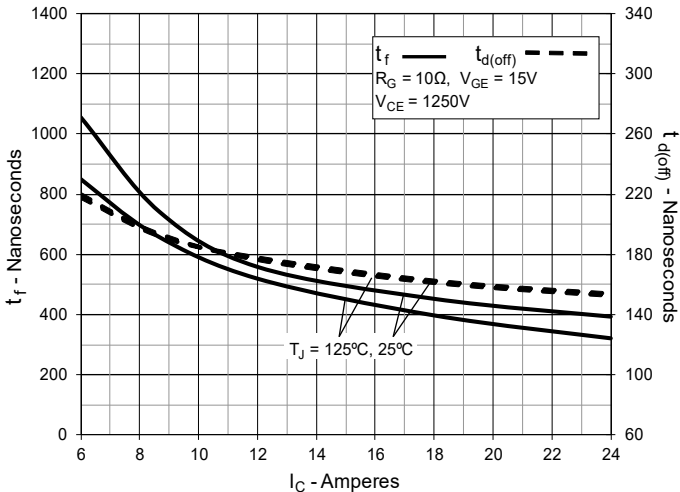

**Fig. 20. Resistive Turn-off Switching Times vs. Gate Resistance**

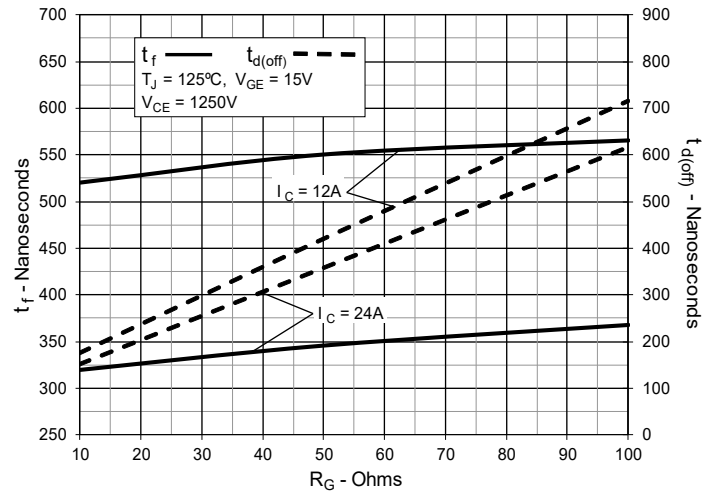

TO-268 Outline

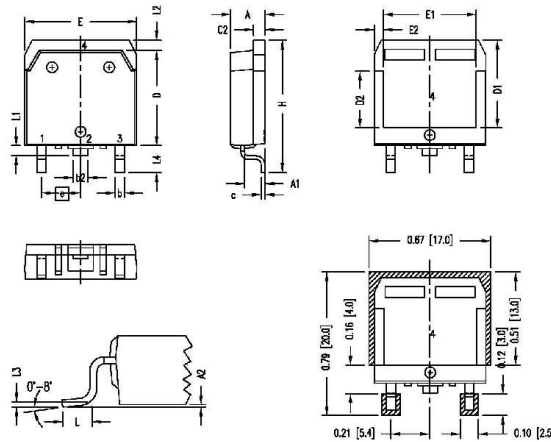

- 1 - Gate
- 2,4 - Collector
- 3 - Emitter

RECOMMENDED MINIMUM FOOT PRINT FOR SMD

SYMBOL	INCHES		MILLIMETERS	
	MIN	MAX	MIN	MAX
A	.193	.201	4.90	5.10
A1	.106	.114	2.70	2.90
A2	.001	.010	0.02	0.25
b	.045	.057	1.15	1.45
b2	.075	.083	1.90	2.10
C	.016	.026	0.40	0.65
C2	.057	.063	1.45	1.60
D	.543	.551	13.80	14.00
D1	.488	.500	12.40	12.70
D2	.320	.335	8.13	8.50
E	.624	.632	15.85	16.05
E1	.524	.535	13.30	13.60
E2	.045	.055	1.14	1.39
e	.215 BSC		5.45 BSC	
H	.736	.752	18.70	19.10
L	.094	.106	2.40	2.70
L1	.047	.055	1.20	1.40
L2	.039	.045	1.00	1.15
L3	.010 BSC		0.25 BSC	
L4	.150	.161	3.80	4.10

NOTE: ALL METAL SURFACE ARE MATTE PURE TIN PLATED EXCEPT TRIM AREA.  
P2 PLATING THICKNESS (4 - 20 um)

TO-247 Outline

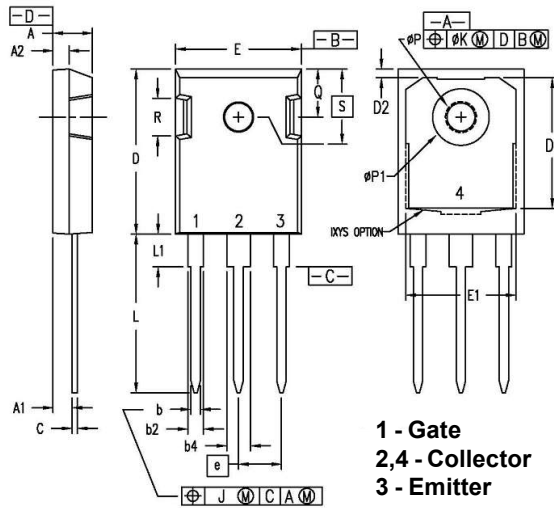

- 1 - Gate
- 2,4 - Collector
- 3 - Emitter

SYM	INCHES		MILLIMETERS	
	MIN	MAX	MIN	MAX
A	.190	.205	4.83	5.21
A1	.090	.100	2.29	2.54
A2	.075	.085	1.91	2.16
b	.045	.055	1.14	1.40
b2	.075	.087	1.91	2.20
b4	.115	.126	2.92	3.20
C	.024	.031	0.61	0.80
D	.819	.840	20.80	21.34
D1	.650	.690	16.51	17.53
D2	.035	.050	0.89	1.27
E	.620	.635	15.75	16.13
E1	.545	.565	13.84	14.35
e	.215 BSC		5.45 BSC	
J	--	.010	--	0.25
K	--	.025	--	0.64
L	.780	.810	19.81	20.57
L1	.150	.170	3.81	4.32
øP	.140	.144	3.55	3.65
øP1	.275	.290	6.99	7.37
Q	.220	.244	5.59	6.20
R	.170	.190	4.32	4.83
S		.242 BSC		6.15 BSC

NOTE: This drawing will meet all dimensions requirement of JEDEC outlines TO-247 AD (R-PSIP-F3)