

Provisional Data
Avalanche Diode
Type W3270N#22A

Absolute Maximum Ratings

	VOLTAGE RATINGS	MAXIMUM LIMITS	UNITS
V_{RRM}	Repetitive peak reverse voltage, (note 1)	2200	V
V_{RSM}	Non-repetitive peak reverse voltage, (note 1)	2300	V
P_{RSM}	Maximum surge reverse power dissipation, (note 2)	100	kW

	OTHER RATINGS	MAXIMUM LIMITS	UNITS
$I_{F(AV)M}$	Maximum average forward current, $T_{sink}=55^{\circ}C$, (note 3)	3239	A
$I_{F(AV)M}$	Maximum average forward current. $T_{sink}=85^{\circ}C$, (note 3)	2670	A
$I_{F(AV)M}$	Maximum average forward current. $T_{sink}=85^{\circ}C$, (note 4)	1630	A
$I_{F(RMS)M}$	Nominal RMS forward current, $T_{sink}=25^{\circ}C$, (note 3)	5887	A
$I_{F(d.c.)}$	D.C. forward current, $T_{sink}=25^{\circ}C$, (note 5)	5015	A
I_{FSM}	Peak non-repetitive surge $t_p=10ms$, $V_{rm}=60\%V_{RRM}$, (note 6)	27.6	kA
I_{FSM2}	Peak non-repetitive surge $t_p=10ms$, $V_{rm}\leq 10V$, (note 6)	30.4	kA
I^2t	I^2t capacity for fusing $t_p=10ms$, $V_{rm}=60\%V_{RRM}$, (note 6)	3.81×10^6	A^2s
I^2t	I^2t capacity for fusing $t_p=10ms$, $V_{rm}\leq 10V$, (note 6)	4.62×10^6	A^2s
$T_{j\ op}$	Operating temperature range	-55 to +175	$^{\circ}C$
T_{stg}	Storage temperature range	-55 to +200	$^{\circ}C$

Notes:-

- 1) De-rating factor of 0.13% per $^{\circ}C$ is applicable for T_j below $25^{\circ}C$.
- 2) In accordance with IEC60747-2 clause 7.3.3.1 (Triangular waveform pulse method), $t_p=3\mu s$.
- 3) Double side cooled, single phase; 50Hz, 180° half-sinewave.
- 4) Single side cooled, single phase; 50Hz, 180° half-sinewave.
- 5) Double side cooled.
- 6) Half-sinewave, $175^{\circ}C$ T_j initial.

Characteristics

	PARAMETER	MIN.	TYP.	MAX.	TEST CONDITIONS (Note 1)	UNITS
V _{FM}	Maximum peak forward voltage	-	-	1.52	I _{TM} =6400A	V
V _{FM}	Maximum peak forward voltage	-	-	1.84	I _{TM} =9800A	V
V _{T0}	Threshold voltage	-	-	0.818		V
r _T	Slope resistance	-	-	0.108		mΩ
I _{RRM}	Peak reverse current	-	-	50	Rated V _{RRM}	mA
I _{RRM}	Peak reverse current	-	-	50	Rated V _{RRM} , T _j =25°C	mA
Q _{rr}	Recovered charge	-	3000	3450		μC
Q _{ra}	Recovered charge, 50% Chord	-	2300	-	I _{TM} =1000A, t _p =1000μs, di/dt=10A/μs, V _r =50V	μC
I _{rr}	Reverse recovery current	-	160	-		A
t _{rr}	Reverse recovery time	-	29	-		μs
R _{thJK}	Thermal resistance, junction to heatsink	-	-	0.022	Double side cooled	K/W
		-	-	0.044	Single side cooled	K/W
F	Mounting force	19	-	26	Note 2	kN
W _t	Weight	-	510	-		g

Notes:-

- 1) Unless otherwise indicated T_j=175°C.
- 2) For other clamp forces, please consult factory.

Notes on rupture rated packages.

This product is available with a non-rupture rated package.

For additional details on these products, please consult factory.

Notes on Ratings and Characteristics

1.0 Voltage Grade Table

Voltage Grade	V_{RRM} V	V_{RSM} V	V_R DC V
22	2200	2300	1350

2.0 Extension of Voltage Grades

This report is applicable to other voltage grades when supply has been agreed by Sales/Production.

3.0 De-rating Factor

A blocking voltage de-rating factor of 0.13%/°C is applicable to this device for T_j below 25°C.

4.0 Snubber Components

When selecting snubber components, care must be taken not to use excessively large values of snubber capacitor or excessively small values of snubber resistor. Such excessive component values may lead to device damage due to the large resultant values of snubber discharge current. If required, please consult the factory for assistance.

5.0 Computer Modelling Parameters

5.1 Device Dissipation Calculations

$$I_{AV} = \frac{-V_{T0} + \sqrt{V_{T0}^2 + 4 \cdot ff^2 \cdot r_T \cdot W_{AV}}}{2 \cdot ff^2 \cdot r_T} \quad \text{and:} \quad W_{AV} = \frac{\Delta T}{R_{th}}$$

$$\Delta T = T_{j\max} - T_K$$

Where $V_{T0}=0.818V$, $r_T=0.108m\Omega$,

R_{th} = Supplementary thermal impedance, see table below and

ff = Form factor, see table below.

Supplementary Thermal Impedance				
Conduction Angle	6 phase (60°)	3 phase (120°)	½ wave (180°)	d.c.
Square wave Double Side Cooled	0.0285	0.0255	0.0240	0.0220
Square wave Single Side Cooled	0.0513	0.0484	0.0469	0.0440
Sine wave Double Side Cooled	0.0257	0.0233	0.022	
Sine wave Single Side Cooled	0.0482	0.0463	0.044	

Form Factors				
Conduction Angle	6 phase (60°)	3 phase (120°)	½ wave (180°)	d.c.
Square wave	2.449	1.732	1.414	1
Sine wave	2.778	1.879	1.57	

5.2 Calculating V_F using ABCD Coefficients

The on-state characteristic I_F vs. V_F , on page 6 is represented in two ways;

- (i) the well established V_{T0} and r_T tangent used for rating purposes and
- (ii) a set of constants A, B, C, D, forming the coefficients of the representative equation for V_F in terms of I_F given below:

$$V_F = A + B \cdot \ln(I_F) + C \cdot I_F + D \cdot \sqrt{I_F}$$

The constants, derived by curve fitting software, are given below for both hot and cold characteristics. The resulting values for V_F agree with the true device characteristic over a current range, which is limited to that plotted.

	25°C Coefficients	175°C Coefficients
A	1.629038	0.7019069
B	-0.1913977	-0.02419013
C	-6.288E-05	4.58848E-05
D	0.02409212	0.009205413

5.3 D.C. Thermal Impedance Calculation

$$r_t = \sum_{p=1}^{p=n} r_p \cdot \left(1 - e^{-\frac{t}{\tau_p}} \right)$$

Where $p = 1$ to n , n is the number of terms in the series and:

- t = Duration of heating pulse in seconds.
- r_t = Thermal resistance at time t .
- r_p = Amplitude of p^{th} term.
- τ_p = Time Constant of r^{th} term.

The coefficients for this device are shown in the tables below:

D.C. Single Side Cooled					
Term	1	2	3	4	5
r_p	0.0291698	4.295845×10^{-3}	7.57109×10^{-3}	2.195801×10^{-3}	1.628753×10^{-3}
τ_p	5.67822	1.123602	0.1407857	0.014381914	1.272749×10^{-3}

D.C. Double Side Cooled				
Term	1	2	3	4
r_p	0.01177146	6.485814×10^{-3}	2.471007×10^{-3}	1.607109×10^{-3}
τ_p	0.9495346	0.1337950	0.01636628	1.255571×10^{-3}

6.0 Reverse recovery ratings

(i) Q_{ra} is based on 50% I_{RM} chord as shown in Fig. 1



Fig. 1

(ii) Q_{rr} is based on a $150\mu s$ integration time i.e.

$$Q_{rr} = \int_0^{150\mu s} i_{rr} \cdot dt$$

(iii) $K \text{ Factor} = \frac{t_1}{t_2}$

Curves

Figure 1 - Forward characteristics of Limit device

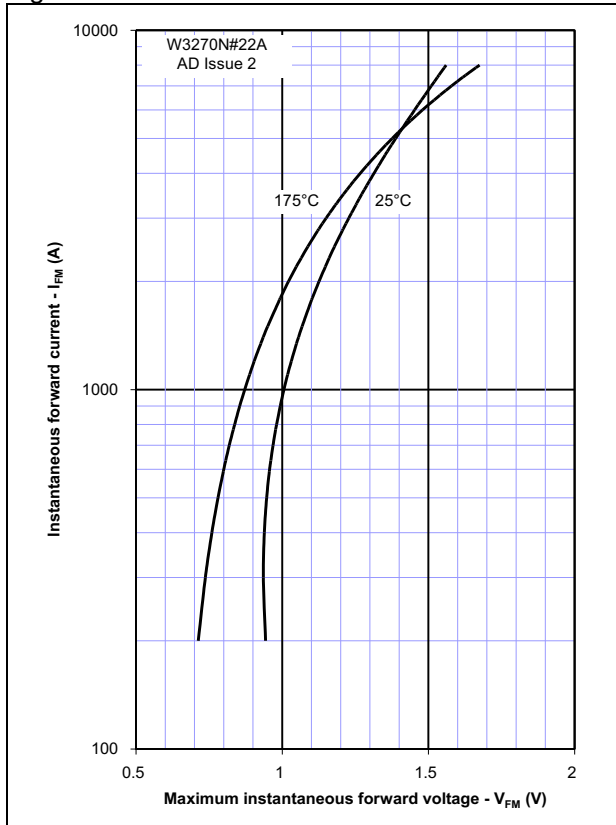

Figure 2 - Transient thermal impedance

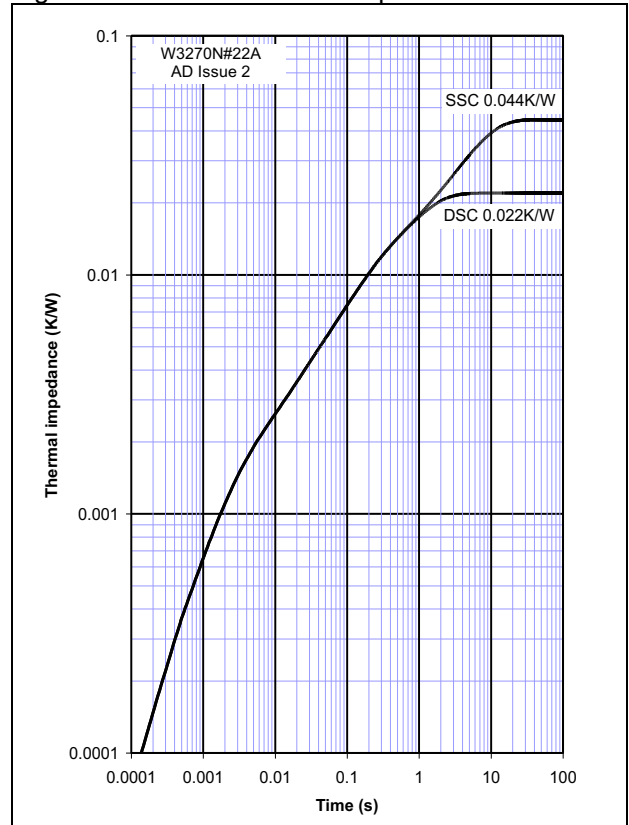

Figure 3 - Maximum surge Rating

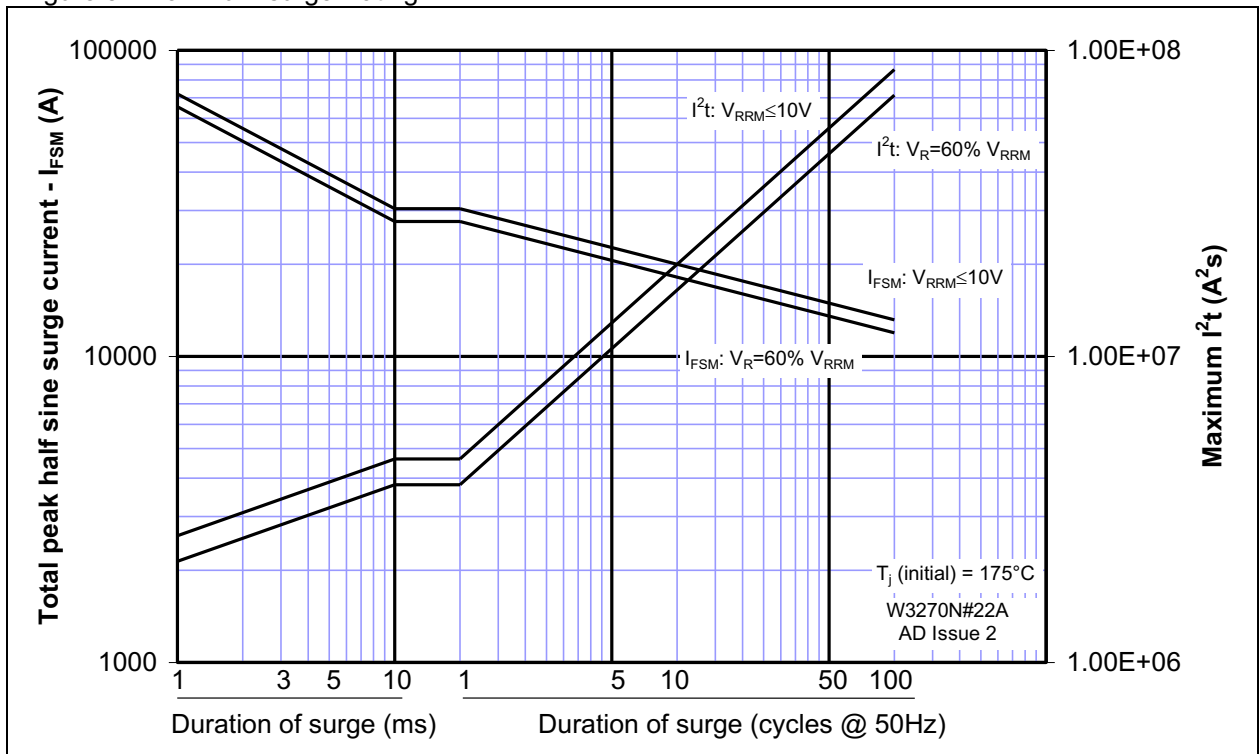

Figure 4 - Total recovered charge, Q_{rr}

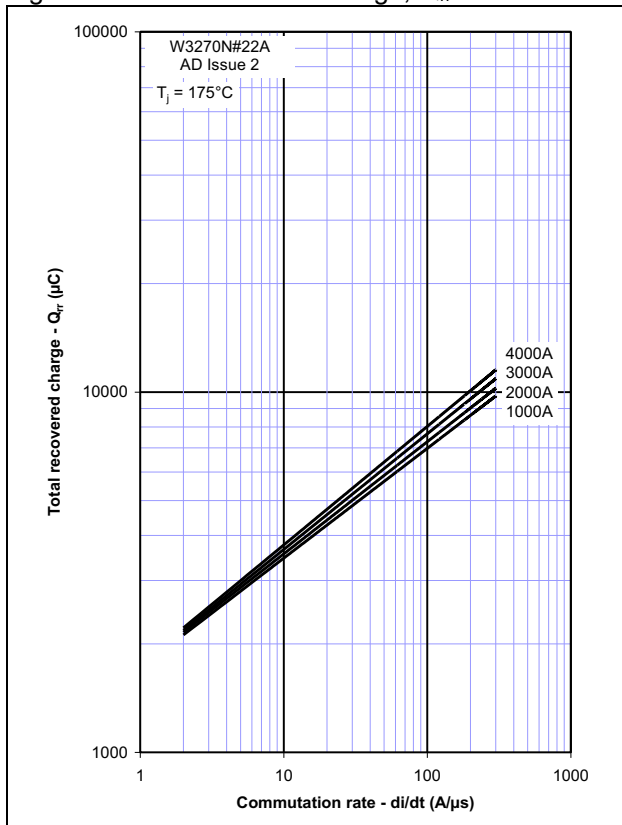

Figure 5 - Recovered charge, Q_{ra} (50% chord)

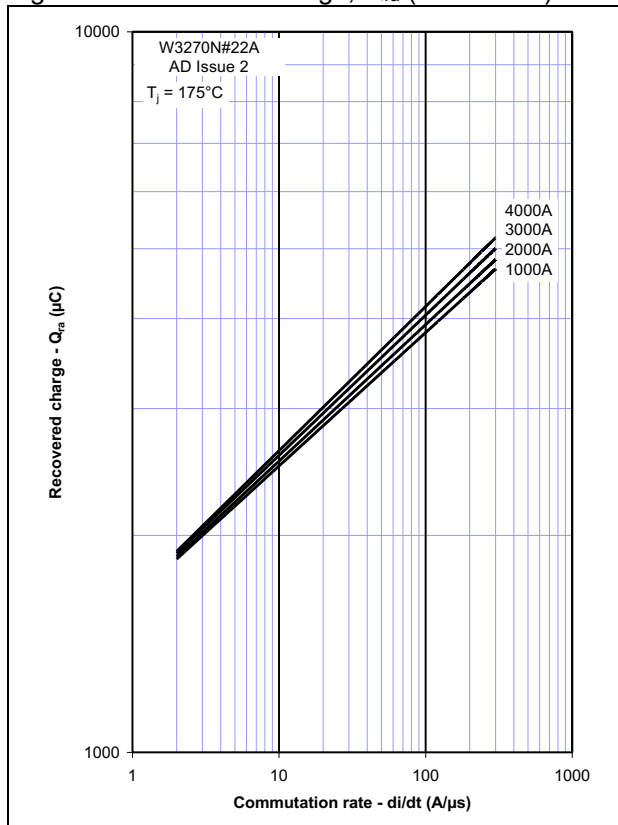

Figure 6 - Peak reverse recovery current, I_{rm}

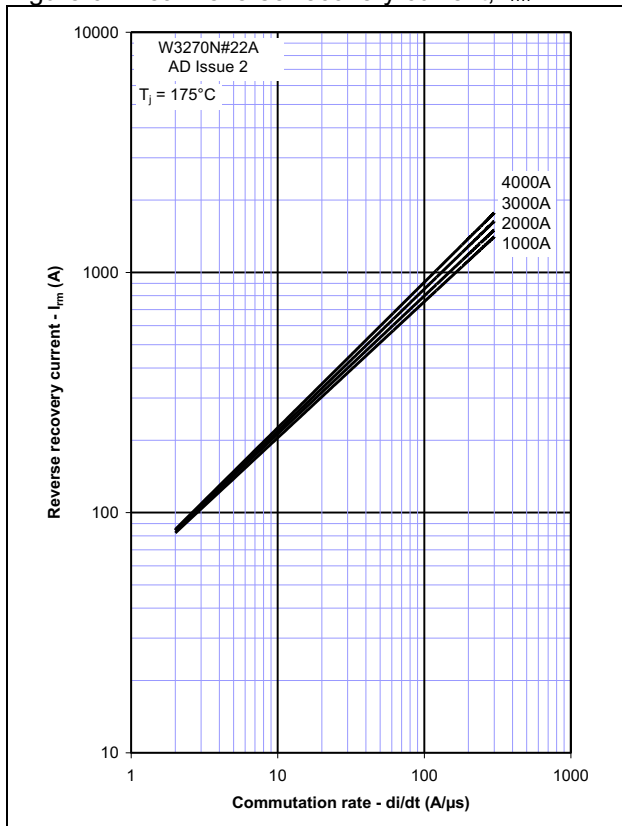

Figure 7 - Maximum recovery time, t_{rr} (50% chord)

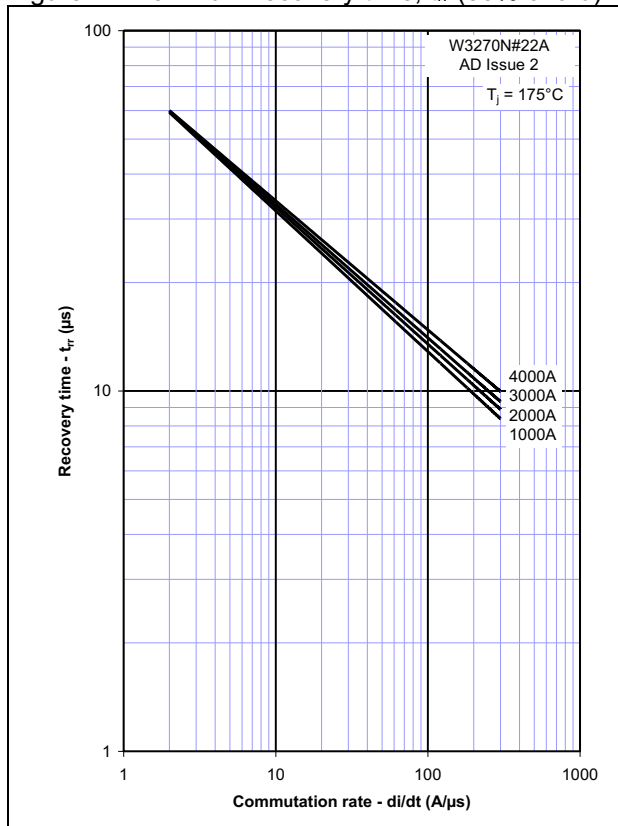

Figure 8 – Forward current vs. Power dissipation – Double Side Cooled

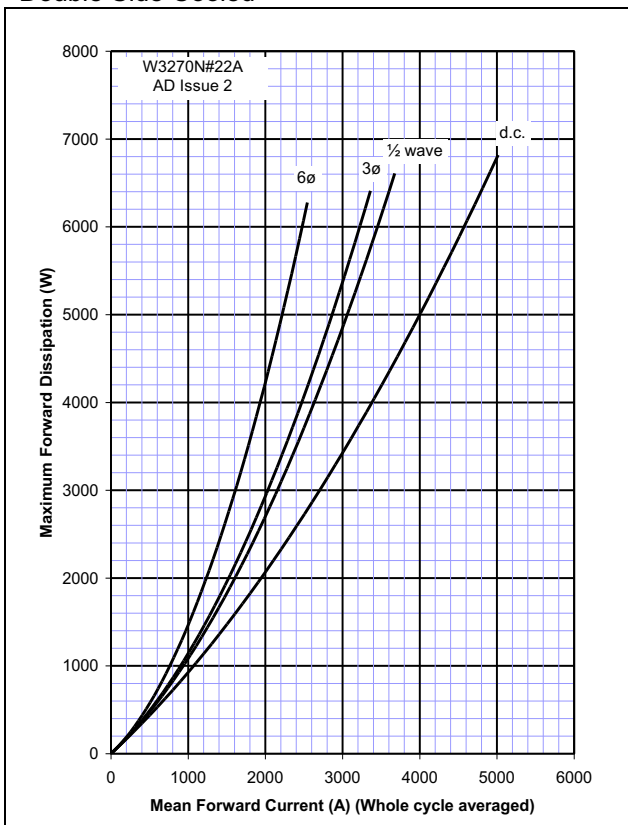

Figure 9 – Forward current vs. Heatsink temperature - Double Side Cooled



Figure 10 – Forward current vs. Power dissipation – Single Side Cooled

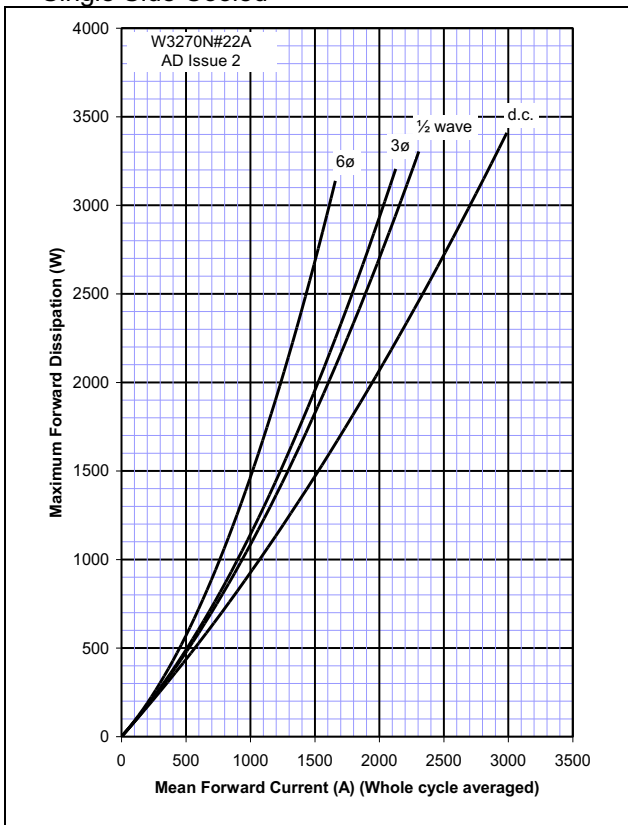
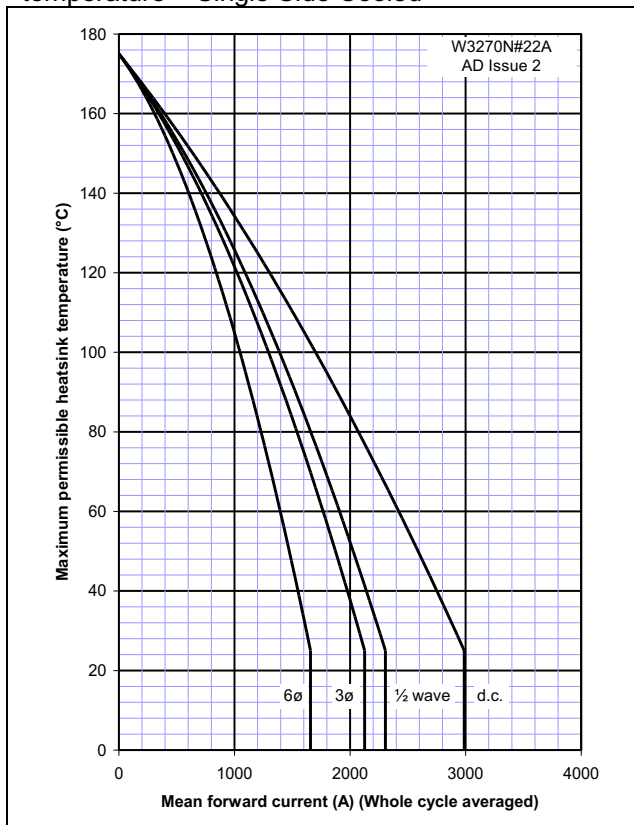
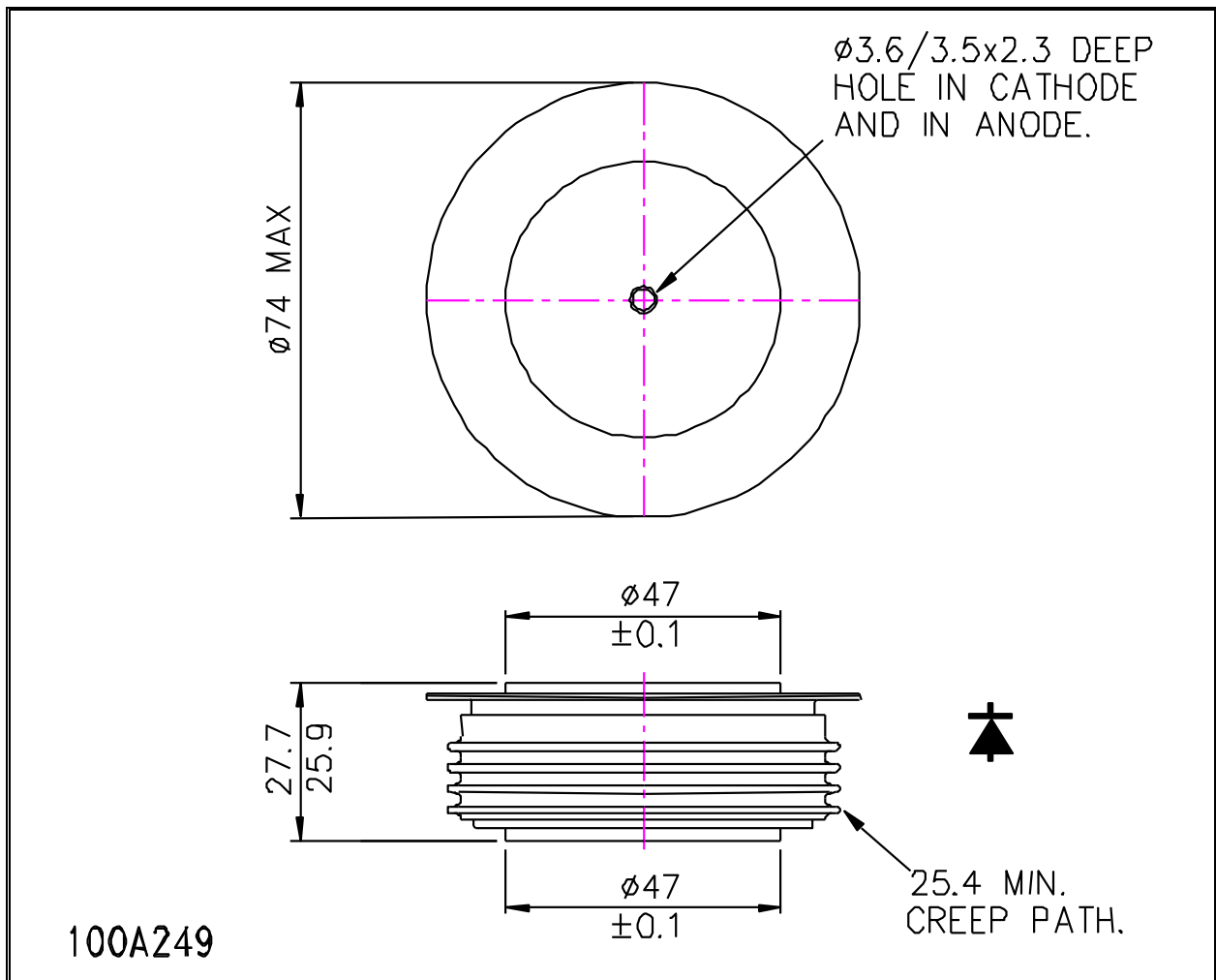

Figure 11 – Forward current vs. Heatsink temperature – Single Side Cooled



Outline Drawing & Ordering Information



100A249

ORDERING INFORMATION

(Please quote 10 digit code as below)

W3270	N#	22	A
Fixed Type Code	Outline code NC = Normal capsule NT = Rupture-rated capsule	Voltage code $V_{DRM}/100$ 22	Fixed code

Typical order code: W3270NT22A – 2200V V_{RRM} , 27.7mm clamp height, rupture rated capsule.

IXYS Semiconductor GmbH
Edisonstraße 15
D-68623 Lampertheim
Tel: +49 6206 503-0
Fax: +49 6206 503-627
E-mail: marcom@ixys.de

WESTCODE
An IXYS Company

Westcode Semiconductors Ltd
Langley Park Way, Langley Park,
Chippenham, Wiltshire, SN15 1GE.
Tel: +44 (0)1249 444524
Fax: +44 (0)1249 659448
E-mail: WSL.sales@westcode.com

IXYS Corporation
1590 Buckeye Drive
Milpitas CA 95035 7418 USA
Tel: +1 (408) 547 9000
Fax: +1 (408) 496 0670
E-mail: sales@ixys.net

www.westcode.com

www.ixys.com

Westcode Semiconductors Inc
3270 Cherry Avenue
Long Beach CA 90807 USA
Tel: +1 (562) 595 6971
Fax: +1 (562) 595 8182
E-mail: WSI.sales@westcode.com

The information contained herein is confidential and is protected by Copyright. The information may not be used or disclosed except with the written permission of and in the manner permitted by the proprietors Westcode Semiconductors Ltd.

© Westcode Semiconductors Ltd.

In the interest of product improvement, Westcode reserves the right to change specifications at any time without prior notice.

Devices with a suffix code (2-letter, 3-letter or letter/digit/letter combination) added to their generic code are not necessarily subject to the conditions and limits contained in this report.



Disclaimer Notice - Information furnished is believed to be accurate and reliable. However, users should independently evaluate the suitability of and test each product selected for their own applications. Littelfuse products are not designed for, and may not be used in, all applications. Read complete Disclaimer Notice at www.littelfuse.com/disclaimer-electronics.