

W6672T#320 & W6672T#350
Rectifier Diode

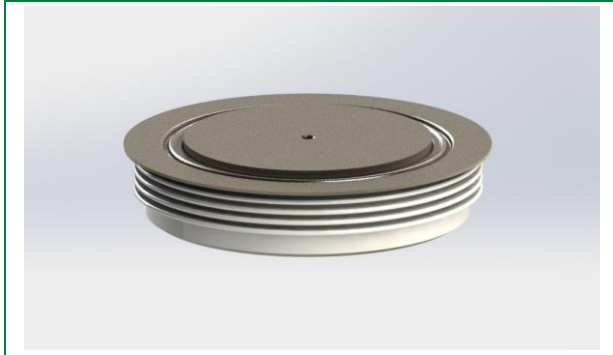

Agency Approvals & Environmental

Environmental Approvals



Component Symbol



Product Summary

Characteristic	Value	Unit
V_{RRM}	3200-3500	V
$I_{F(AV)M}$ ($T_{SINK} = 55\text{ }^{\circ}\text{C}$)	6672	A
I_{FSM}	73.0	kA
$R_{th,JK}$ DSC	0.008	K/W

Features

- Low conduction losses
- High temperature alloyed die construction
- Low thermal impedance
- Available in 26mm and 35mm package heights
- High power cycling capability

Applications

- Line frequency applications up to 400Hz
- Traction converters
- Trackage substations
- DC Power supplies
- Input rectifiers for Variable speed drives

Benefits

- High over-load capacity
- High power density

1. Maximum Ratings 3

2. Characteristics 3

3. Notes on Ratings and Characteristics 4

 3.1. Voltage Grade Table 4

 3.2. Extension of Voltage Grades 4

 3.3. De-rating Factor 4

 3.4. Snubber Components 4

 3.5. Computer Modelling Parameters 4

 3.5.1. Device Dissipation Calculations 4

 3.6. Calculating V_F using ABCD Coefficients 5

 3.7. DC Thermal Impedance Calculation 5

 3.8. Reverse Recovery Ratings 6

4. Performance Curves 7

5. Package Dimensions 10

6. Ordering Information 10

7. Packing Options 10

1. Maximum Ratings

Voltage Ratings	Symbol	Value	Unit
Repetitive Peak Reverse Voltage ⁽¹⁾	V _{RRM}	3200-3500	V
Non-repetitive Peak Reverse Voltage ⁽¹⁾	V _{RSM}	3300-3600	V

Ratings	Symbol	Value	Unit
Maximum Average Forward Current, T _{SINK} = 55 °C ⁽²⁾	I _{F(AV)M}	6672	A
Maximum Average Forward Current, T _{SINK} = 100 °C ⁽²⁾	I _{F(AV)M}	4612	A
Maximum Average Forward Current, T _{SINK} = 100 °C ⁽³⁾	I _{F(AV)M}	2384	A
Nominal RMS Forward Current, T _{SINK} = 25 °C ⁽²⁾	I _{F(RMS)M}	12288	A
D.C. Forward Current, T _{SINK} = 25 °C ⁽⁴⁾	I _{F(DC)}	10682	A
Peak Non-repetitive Surge, t _p = 10 ms, V _{RM} = 60% V _{RRM} ⁽⁵⁾	I _{FSM}	65.7	kA
Peak Non-repetitive Surge, t _p = 10 ms, V _{RM} ≤ 10 V ⁽⁵⁾	I _{FSM2}	73.0	kA
I ² t capacity for Fusing, t _p = 10 ms, V _{RM} = 60% V _{RRM} ⁽⁵⁾	I ² t	21.58 x 10 ⁶	A ² s
I ² t capacity for Fusing, t _p = 10 ms, V _{RM} ≤ 10 V ⁽⁵⁾	I ² t	26.65 x 10 ⁶	A ² s
Operating Temperature range	T _{J,OP}	-40 to +160	°C
Storage Temperature Range	T _{STG}	-55 to +160	°C

Footnote 1: De-rating factor of 0.13% per °C is applicable for T_J below 25 °C

Footnote 2: Double side cooled, single phase; 50 Hz, 180° half-sinewave

Footnote 3: Cathode side cooled, single phase; 50 Hz, 180° half-sinewave

Footnote 4: Double side cooled

Footnote 5: Half-sinewave, 160 °C T_J initial

2. Characteristics

Characteristic	Symbol	Conditions	Value			Unit
			Min	Typ	Max	
Maximum Peak Forward Voltage	V _{FM}	I _{FM} = 5000 A	-	-	1.18	V
		I _{FM} = 8000 A	-	-	1.37	
Threshold Voltage	V ₀	-	-	-	0.864	V
Slope Resistance	r _s	-	-	-	0.067	mΩ
Peak Reverse Current	I _{RRM}	Rated V _{RRM}	-	-	100	mA
Recovered Charge	Q _{rr}	I _{TM} = 4000 A, t _p = 1000 μs, di/dt = 10 A/μs, V _r = 100 V	-	9500	-	μC
Recovered Charge, 50% Chord	Q _{ra}		-	7200	7900	μC
Reverse Recovery Current	I _{rm}		-	280	-	A
Reverse Recovery Time, 50% Chord	t _{rr}		-	52	-	μs
Thermal Resistance, Junction to Heatsink	R _{th,Jk}	Double Side Cooled	-	-	0.008	K/W
		Anode Side Cooled	-	-	0.013	
		Cathode Side Cooled	-	-	0.020	
Mounting Force	F	For other clamp forces, please consult factory	60	-	70	kN
Weight	W _t	-	-	1.2	-	kg

Note: Unless otherwise indicated, T_J = 160 °C

3. Notes on Ratings and Characteristics

3.1. Voltage Grade Table

Voltage Grade	V_{RRM} (V)	V_{RSM} (V)	V_R (V _{DC})
32	3200	3300	1750
35	3500	3600	1900

3.2. Extension of Voltage Grades

This report is applicable to other voltage grades when supply has been agreed by Sales/Production.

3.3. De-rating Factor

A blocking voltage de-rating factor of 0.13%/°C is applicable to this device for T_J below 25 °C.

3.4. Snubber Components

When selecting snubber components, care must be taken not to use excessively large values of snubber capacitor or excessively small values of snubber resistor. Such excessive component values may lead to device damage due to the large resultant values of snubber discharge current. If required, please consult the factory for assistance.

3.5. Computer Modelling Parameters

3.5.1. Device Dissipation Calculations

$$I_{AV} = \frac{-V_0 + \sqrt{V_0^2 + 4 \cdot ff^2 \cdot r_s \cdot W_{AV}}}{2 \cdot ff^2 \cdot r_s}$$

and

$$W_{AV} = \frac{\Delta T}{R_{th}}$$

$$\Delta T = T_{J,Max} - T_K$$

Where:

- $V_0 = 0.864$ V
- $r_s = 0.067$ mΩ
- R_{th} = Supplementary thermal impedance, see Table 1 below
- ff = Form factor, see Table 2 below

Supplementary Thermal Impedance				
Conduction Angle	6 Phase (60°)	3 Phase (120°)	½ Phase (180°)	DC
Square Wave Double Side Cooled	0.00866	0.00847	0.00832	0.00800
Square Wave Cathode Side Cooled	0.02118	0.02101	0.02086	0.02000
Sine Wave Double Side Cooled	0.00855	0.00837	0.00813	-
Sine Wave Cathode Side Cooled	0.02108	0.02091	0.02068	-

Table 1. Supplementary Thermal Impedance Values

Form Factors				
Conduction Angle	6 Phase (60°)	3 Phase (120°)	½ Phase (180°)	DC
Square Wave	2.449	1.732	1.414	1
Sine Wave	2.778	1.879	1.57	-

Table 2. Form Factor Values

3.6. Calculating V_F using ABCD Coefficients

The on-state characteristic I_F vs. V_F , on page 7 are represented in two ways:

- The well-established V_0 and r_s tangent used for rating purposes
- A set of constants A, B, C, D, forming the coefficients of the representative equation for V_F in terms of I_F given below:

$$V_F = A + B \cdot \ln(I_F) + C \cdot I_F + D \cdot \sqrt{I_F}$$

The constants, derived by curve fitting software, are given below for both hot and cold characteristics. The resulting values for V_F agree with the true device characteristic over a current range, which is limited to that plotted.

25 °C Coefficients		160 °C Coefficients	
A	0.7063900	A	0.39067
B	0.01555266	B	0.033410
C	2.926184×10^{-5}	C	4.7250×10^{-5}
D	3.197501×10^{-3}	D	3.8157×10^{-3}

3.7. DC Thermal Impedance Calculation

$$r_t = \sum_{p=1}^{p=n} r_p \cdot \left(1 - e^{-\frac{t}{\tau_p}}\right)$$

Where $p = 1$ to n , n is the number of terms in the series and:

- T = Duration of heating pulse in seconds
- r_t = Thermal resistance at time t
- r_p = Amplitude of p^{th} term
- τ_p = Time constant of r_{th} term

The coefficients for this device are show in the tables below:

D.C. Double Side Cooled				
Term	1	2	3	4
r_p	3.81150×10^{-3}	1.89558×10^{-3}	1.71360×10^{-3}	5.24282×10^{-3}
τ_p	1.01434	0.34872	0.08992	0.01065

Table 3. Coefficient Values for D.C. Double Side Cooled

D.C. Cathode Side Cooled			
Term	1	2	3
r_p	0.01653	3.37618×10^{-3}	5.93598×10^{-4}
τ_p	5.31595	0.15120	0.01207

Table 4. Coefficient Values for D.C. Cathode Side Cooled

3.8. Reverse Recovery Ratings

- Q_{rr} is based on 50% I_{RM} chord as shown in Diagram 1

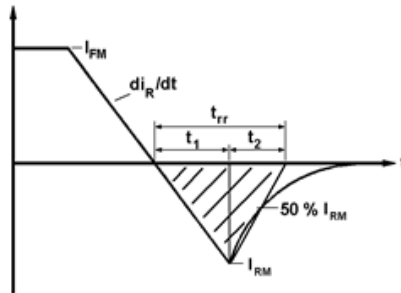

Diagram 1. Reverse Recovery Waveform Example

- Q_{rr} is based on a 150 μs integration time. I.e.: $Q_{rr} = \int_0^{150 \mu\text{s}} i_{rr} \cdot dt$
- $K \text{ Factor} = \frac{t_1}{t_2}$

4. Performance Curves

Figure 1. Forward Characteristics of Limit Device

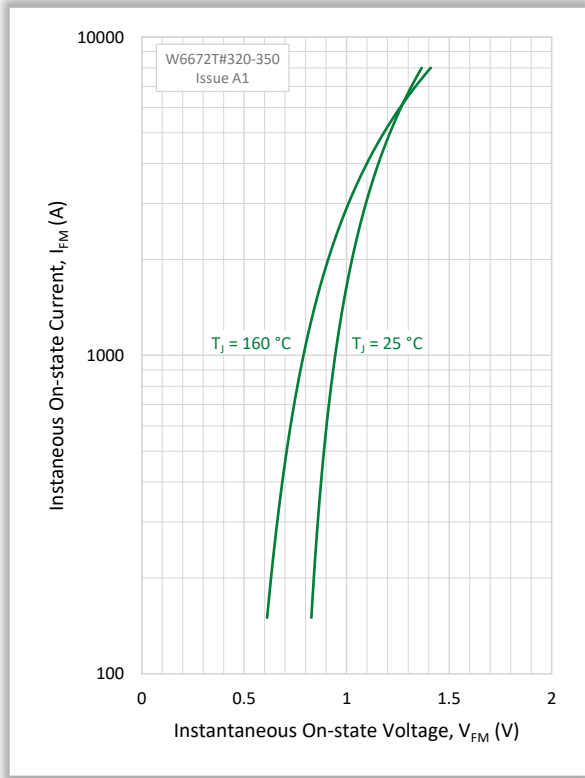

Figure 2. Transient Thermal Impedance

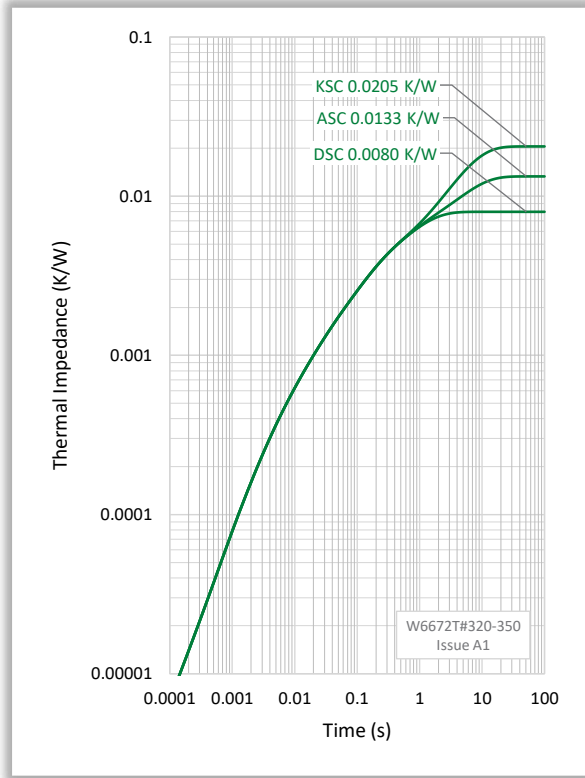

Figure 3. Total Recovered Charge, Q_{rr}

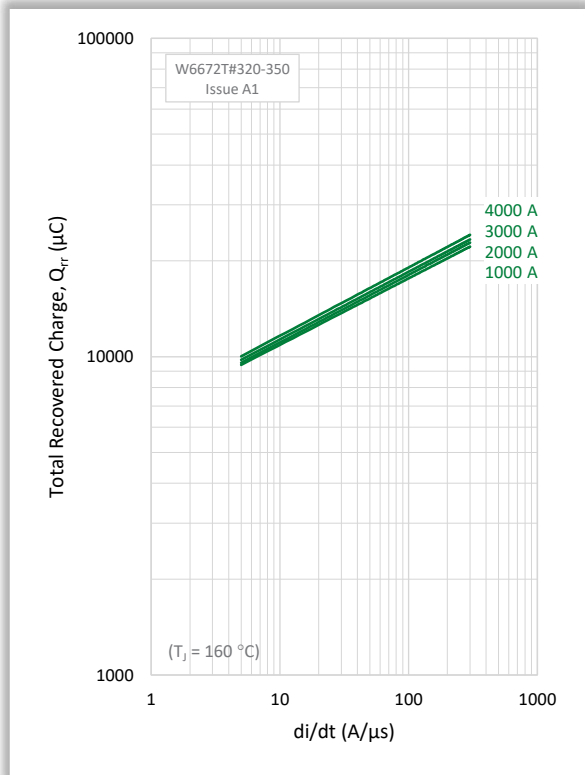

Figure 4. Recovered Charge, Q_{ra} (50% Chord)

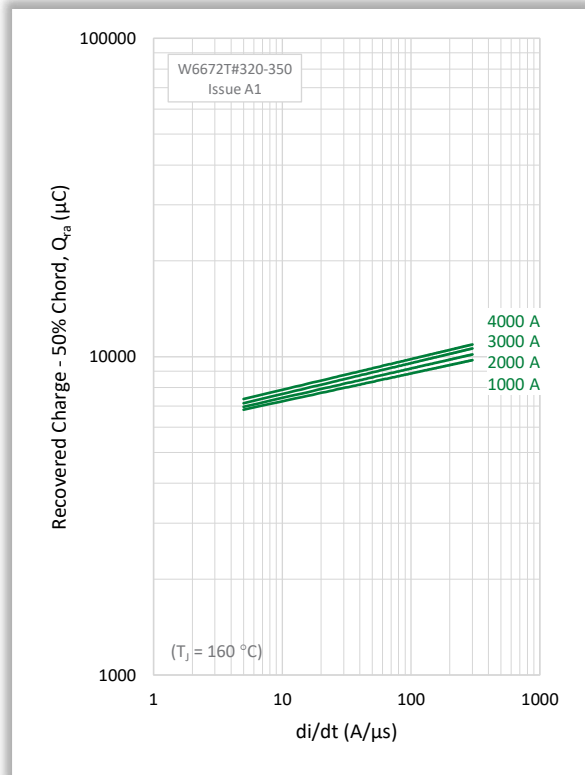

Figure 5. Peak Reverse Recovery Current, I_{rm}

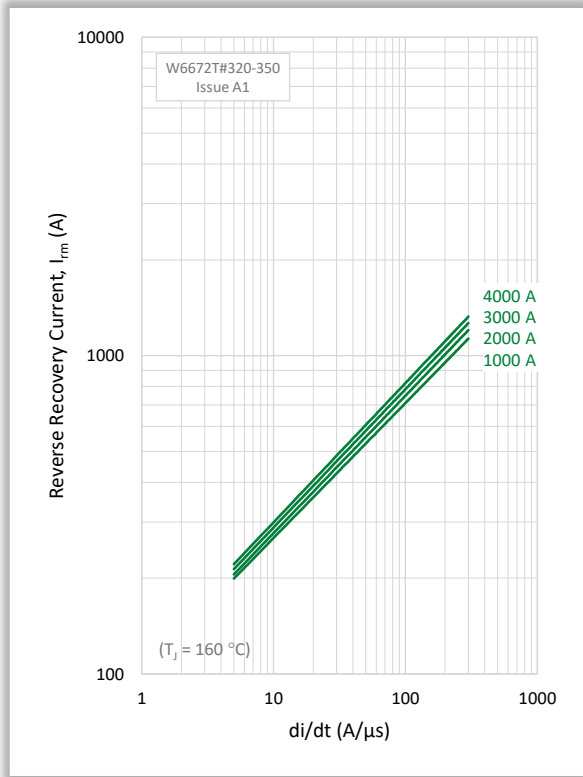

Figure 6. Maximum Recovery Time, t_{rr} (50% Chord)

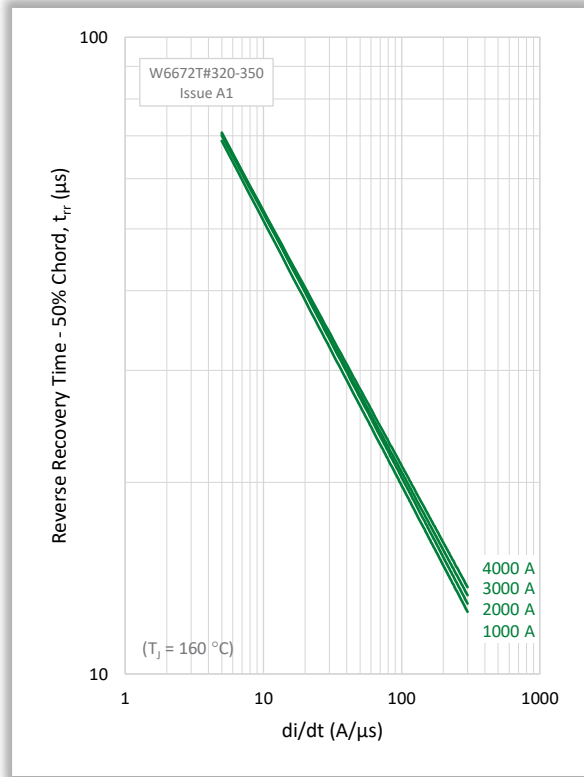

Figure 7. Forward Current vs. Power Dissipation (Double Side Cooled)

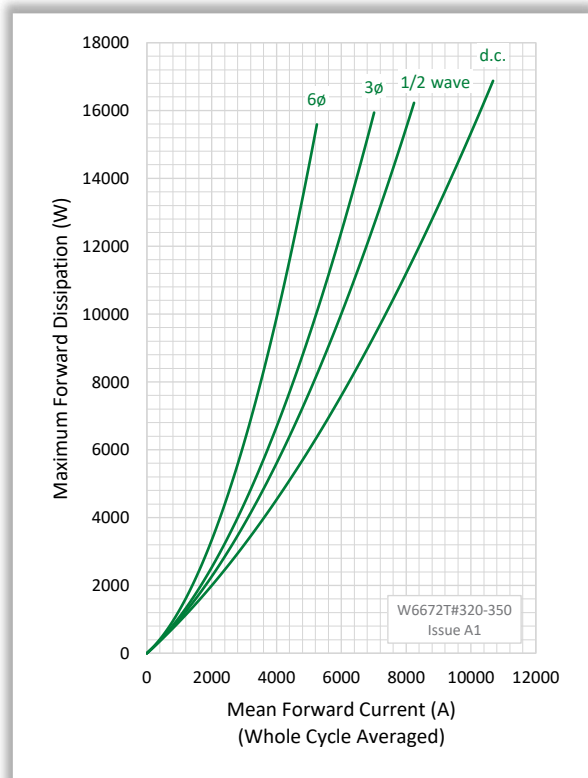

Figure 8. Forward Current vs. Heat Sink Temperature (Double Side Cooled)

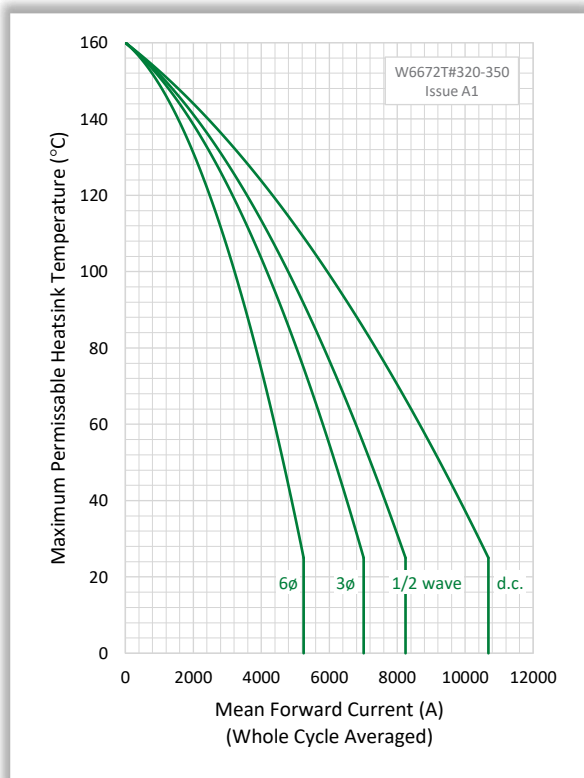

Figure 9. Forward Current vs. Power Dissipation (Cathode Side Cooled)

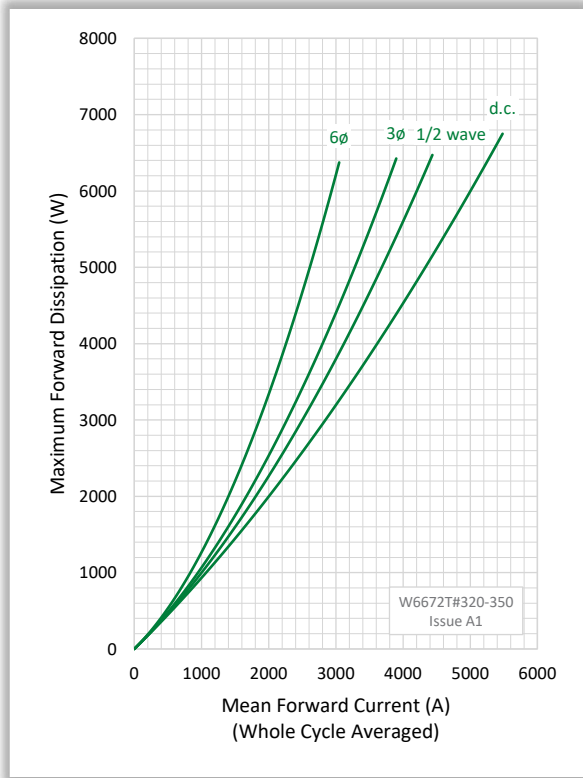

Figure 10. Forward Current vs. Heatsink Temperature (Cathode Side Cooled)

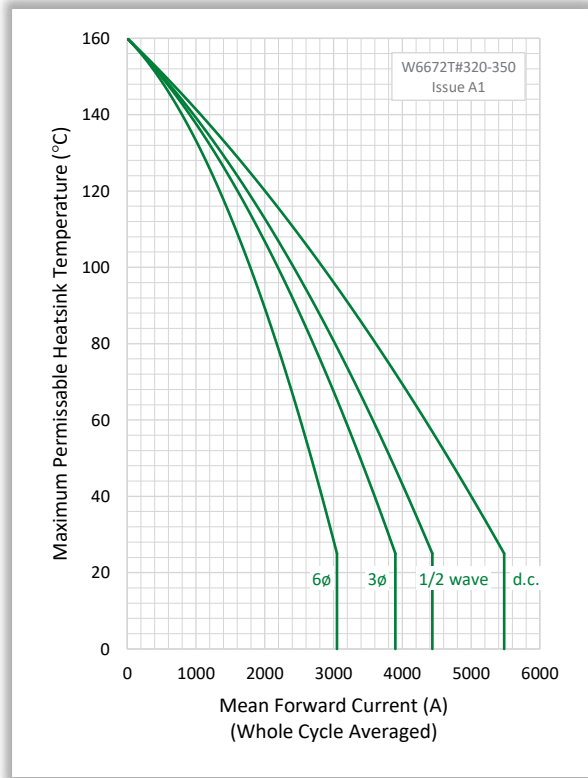
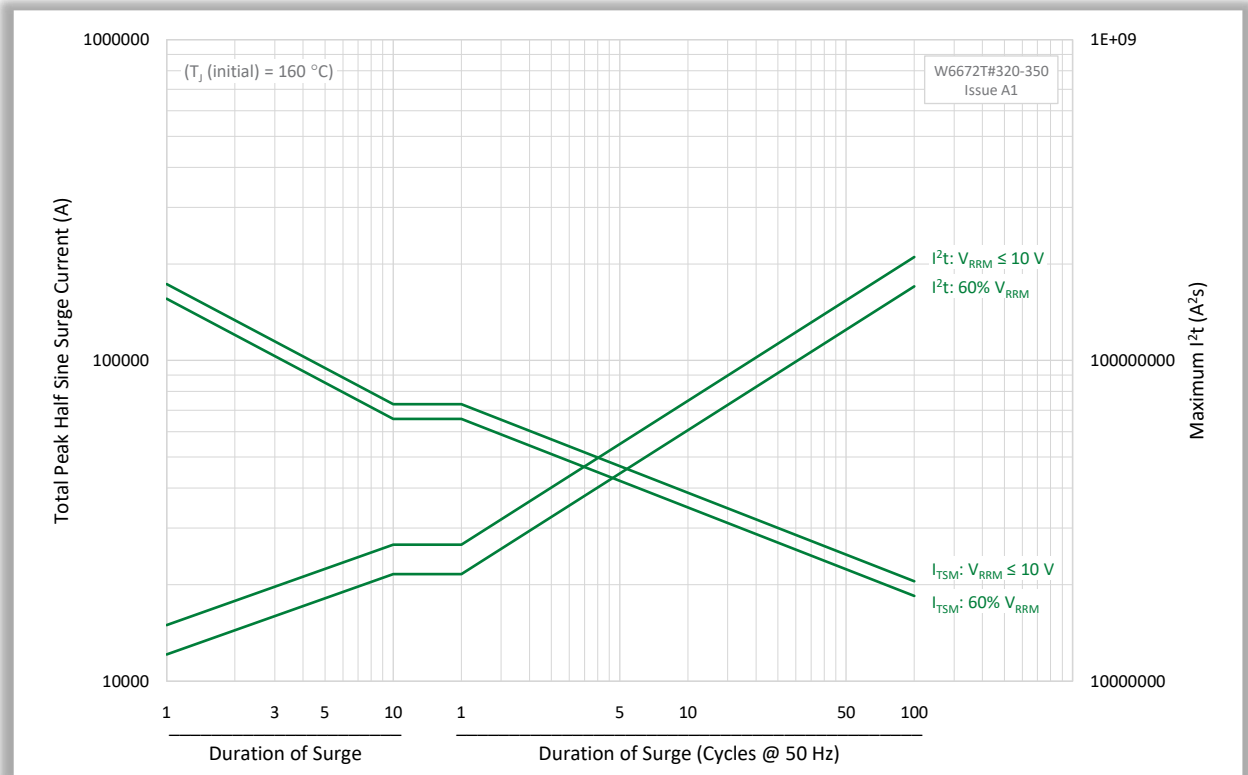
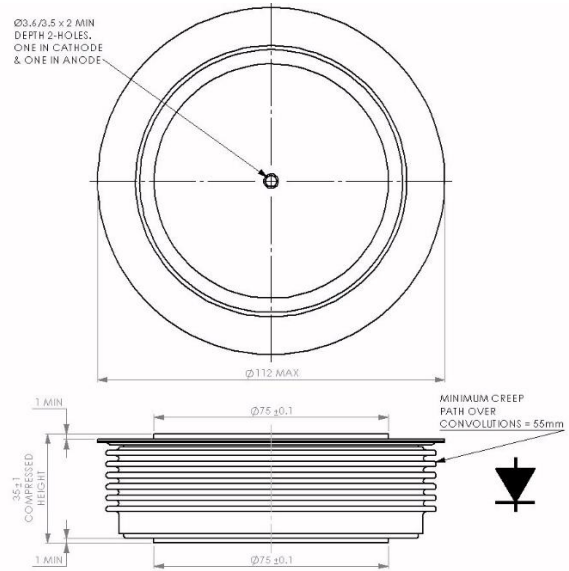
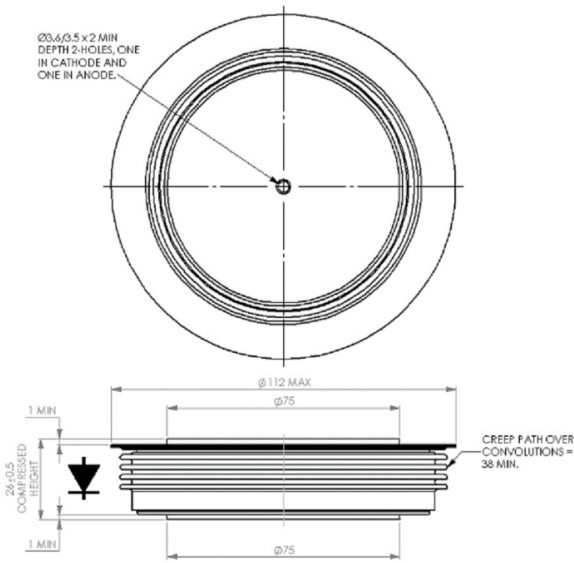

Figure 11. Maximum Surge Current



5. Package Dimensions



6. Ordering Information

W6672	Outline Code	$\diamond\diamond$	0
Fixed Type Code	TE = 35 ± 1 mm TJ = 26 ± 1 mm	Voltage Code $V_{RRM}/100$ 32-35	Fixed Code

Order Code: W6672TJ350 – 3500 V_{RRM} , 26 mm clamp height capsule

7. Packing Options

Part Number	M.O.Q.
W6672TJ320	1
W6672TJ350	1
W6672TE320	1
W6672TE350	1

For additional information please visit www.Littelfuse.com/powersemi

Disclaimer Notice - Littelfuse products are not designed for, and shall not be used for, any purpose (including, without limitation, automotive, military, aerospace, medical, life-saving, life-sustaining or nuclear facility applications, devices intended for surgical implant into the body, or any other application in which the failure or lack of desired operation of the product may result in personal injury, death, or property damage) other than those expressly forth in applicable Littelfuse product documentation. Littelfuse shall not be liable for any claims or damages arising out of products used in applications not expressly intended by Littelfuse as set forth in applicable Littelfuse documentation.

Read complete Disclaimer Notice at www.littelfuse.com/disclaimer-electronics