

Fast Recovery Diode

Type M1010NC400 to M1010NC450

Old Type No.: SM30-45CXC604

Absolute Maximum Ratings

	VOLTAGE RATINGS	MAXIMUM LIMITS	UNITS
V_{RRM}	Repetitive peak reverse voltage, (note 1)	4000-4500	V
V_{RSM}	Non-repetitive peak reverse voltage, (note 1)	4100-4600	V

	OTHER RATINGS	MAXIMUM LIMITS	UNITS
$I_{F(AV)M}$	Maximum average forward current, $T_{sink}=55^{\circ}C$, (note 2)	1010	A
$I_{F(AV)M}$	Maximum average forward current. $T_{sink}=100^{\circ}C$, (note 2)	668	A
$I_{F(AV)M}$	Maximum average forward. $T_{sink}=100^{\circ}C$, (note 3)	413	A
$I_{F(RMS)}$	Nominal RMS forward current, $T_{sink}=25^{\circ}C$, (note 2)	1880	A
$I_{f(d.c.)}$	D.C. forward current, $T_{sink}=25^{\circ}C$, (note 4)	1664	A
I_{FSM}	Peak non-repetitive surge $t_p=10ms$, $V_{RM}=60\%V_{RRM}$, (note 5)	9600	A
I_{FSM2}	Peak non-repetitive surge $t_p=10ms$, $V_{RM}\leq 10V$, (note 5)	10560	A
I^2t	I^2t capacity for fusing $t_p=10ms$, $V_{RM}=60\%V_{RRM}$, (note 5)	461×10^3	A^2s
I^2t	I^2t capacity for fusing $t_p=10ms$, $V_{RM}\leq 10V$, (note 5)	558×10^3	A^2s
$T_{j\ op}$	Operating temperature range	-40 to +150	$^{\circ}C$
T_{stg}	Storage temperature range	-40 to +150	$^{\circ}C$

Notes:-

- 1) De-rating factor of 0.13% per $^{\circ}C$ is applicable for T_j below $25^{\circ}C$.
- 2) Double side cooled, single phase; 50Hz, 180° half-sinewave.
- 3) Single side cooled, single phase; 50Hz, 180° half-sinewave.
- 4) Double side cooled.
- 5) Half-sinewave, $150^{\circ}C$ T_j initial.

Characteristics

	PARAMETER	MIN.	TYP.	MAX.	TEST CONDITIONS (Note 1)	UNITS
V_{FM}	Maximum peak forward voltage	-	-	3.25	$I_{FM}=1500A$	V
		-	-	3.7	$I_{FM}=2020A$	
V_{T0}	Threshold voltage	-	-	1.70		V
r_T	Slope resistance	-	-	1.03		m Ω
V_{FRM}	Maximum forward recovery voltage	-	-	65	$di/dt = 1000A/\mu s, T_j=25^\circ C$	V
		-	-	160	$di/dt = 1000A/\mu s$	
I_{RRM}	Peak reverse current	-	-	150	Rated V_{RRM}	mA
Q_{rr}	Recovered charge	-	1450	-		μC
Q_{ra}	Recovered charge, 50% Chord	-	700	950	$I_{FM}=1000A, t_p=500\mu s, di/dt=200A/\mu s,$ $V_r=50V, 50\% \text{ Chord.}$	μC
I_{rm}	Reverse recovery current	-	440	-		A
t_{rr}	Reverse recovery time, 50% Chord	-	3.2	-		μs
R_{thJK}	Thermal resistance, junction to heatsink	-	-	0.022	Double side cooled	K/W
		-	-	0.044	Single side cooled	
F	Mounting force	19	-	26		kN
W_t	Weight	-	510	-		g

Notes:-

- 1) Unless otherwise indicated $T_j=150^\circ C$.
- 2) For other clamp forces, please consult factory.

Notes on Ratings and Characteristics

1.0 Voltage Grade Table

Voltage Grade	V _{RRM} (V)	V _{RSM} (V)	V _R dc (V)
40	4000	4100	2000
42	4200	4300	2040
44	4400	4500	2080
45	4500	4600	3000

2.0 De-rating Factor

A blocking voltage de-rating factor of 0.13% per °C is applicable to this device for T_j below 25°C.

3.0 ABCD Constants

These constants (applicable only over current range of V_F characteristic in Figure 1) are the coefficients of the expression for the forward characteristic given below:

$$V_F = A + B \cdot \ln(I_F) + C \cdot I_F + D \cdot \sqrt{I_F}$$

where I_F = instantaneous forward current.

4.0 Reverse recovery ratings

(i) Q_{ra} is based on 50% I_{rm} chord as shown in Fig.(a) below.

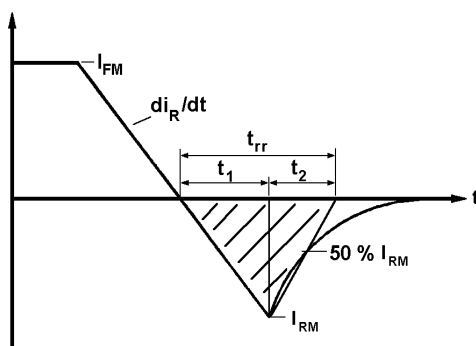

(ii) Q_{rr} is based on a 150μs integration time.

i.e.

$$Q_{rr} = \int_0^{150\mu s} i_{rr} \cdot dt$$

(iii)

$$K \text{ Factor} = \frac{t_1}{t_2}$$

5.0 Reverse Recovery Loss

The following procedure is recommended for use where it is necessary to include reverse recovery loss.

From waveforms of recovery current obtained from a high frequency shunt (see Note 1) and reverse voltage present during recovery, an instantaneous reverse recovery loss waveform must be constructed. Let the area under this waveform be E joules per pulse. A new sink temperature can then be evaluated from:

$$T_{SINK} = T_{J(MAX)} - E \cdot [k + f \cdot R_{thJK}]$$

Where $k = 0.2314$ ($^{\circ}\text{C}/\text{W}$)/s

E = Area under reverse loss waveform per pulse in joules (W.s.)

f = Rated frequency in Hz at the original sink temperature.

R_{thJK} = d.c. thermal resistance ($^{\circ}\text{C}/\text{W}$)

The total dissipation is now given by:

$$W_{(tot)} = W_{(original)} + E \cdot f$$

NOTE 1 - Reverse Recovery Loss by Measurement

This device has a low reverse recovered charge and peak reverse recovery current. When measuring the charge, care must be taken to ensure that:

(a) AC coupled devices such as current transformers are not affected by prior passage of high amplitude forward current.

(b) A suitable, polarised, clipping circuit must be connected to the input of the measuring oscilloscope to avoid overloading the internal amplifiers by the relatively high amplitude forward current signal.

(c) Measurement of reverse recovery waveform should be carried out with an appropriate critically damped snubber, connected across diode anode to cathode. The formula used for the calculation of this snubber is shown below:

$$R^2 = 4 \cdot \frac{V_r}{C_s \cdot di/dt}$$

Where: V_r = Commutating source voltage

C_s = Snubber capacitance

R = Snubber resistance

6.0 Snubber Components

When selecting snubber components, care must be taken not to use excessively large values of snubber capacitor or excessively small values of snubber resistor. Such excessive component values may lead to device damage due to the large resultant values of snubber discharge current. If required, please consult the factory for assistance.

7.0 Computer Modelling Parameters

7.1 Device Dissipation Calculations

$$I_{AV} = \frac{-V_{T0} + \sqrt{V_{T0}^2 + 4 \cdot ff^2 \cdot r_T \cdot W_{AV}}}{2 \cdot ff^2 \cdot r_T}$$

Where $V_{T0} = 1.7V$, $r_T = 1.03m\Omega$

ff = form factor (normally unity for fast diode applications)

$$W_{AV} = \frac{\Delta T}{R_{th}}$$

$$\Delta T = T_{j(MAX)} - T_K$$

7.2 Calculation of V_F using ABCD Coefficients

The forward characteristic I_F Vs V_F , on page 6 is represented in two ways;

- (i) the well established V_{T0} and r_T tangent used for rating purposes and
- (ii) a set of constants A, B, C, and D forming the coefficients of the representative equation for V_F in terms of I_F given below:

$$V_F = A + B \cdot \ln(I_F) + C \cdot I_F + D \cdot \sqrt{I_F}$$

The constants, derived by curve fitting software, are given in this report for both hot and cold characteristics. The resulting values for V_F agree with the true device characteristic over a current range, which is limited to that plotted.

	25°C Coefficients	150°C Coefficients
A	0.12244226	0.48090081
B	0.3167849	0.08739151
C	5.562×10^{-4}	3.69724×10^{-4}
D	9.6916×10^{-4}	0.04067666

8.0 Frequency Ratings

The curves illustrated in figures 8 to 16 are for guidance only and are superseded by the maximum ratings shown on page 1.

9.0 Square wave ratings

These ratings are given for load component rate of rise of forward current of 100 and 500 A/ μ s.

10.0 Duty cycle lines

The 100% duty cycle is represented on all the ratings by a straight line. Other duties can be included as parallel to the first.

Curves

Figure 1 – Forward characteristics of Limit device

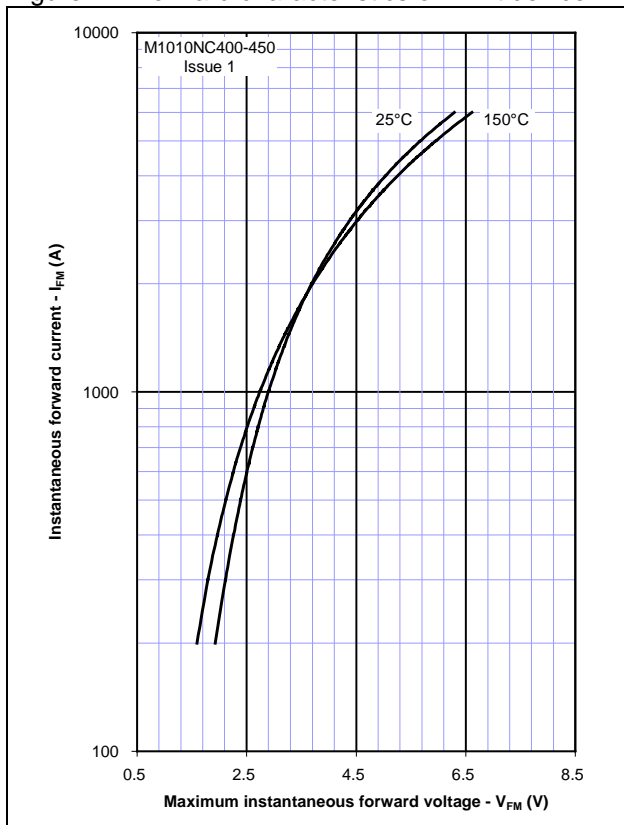

Figure 2 – Maximum forward recovery voltage

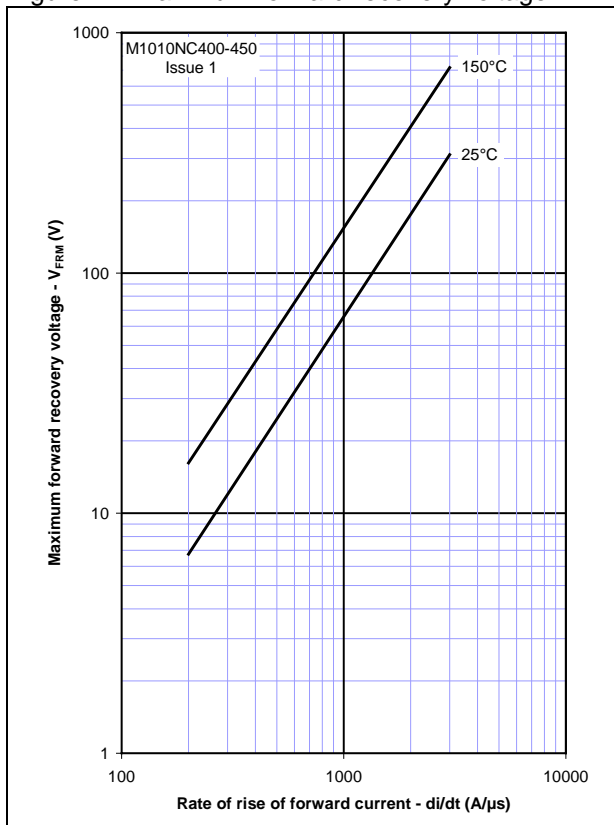

Figure 3 - Recovered charge, Q_{rr}

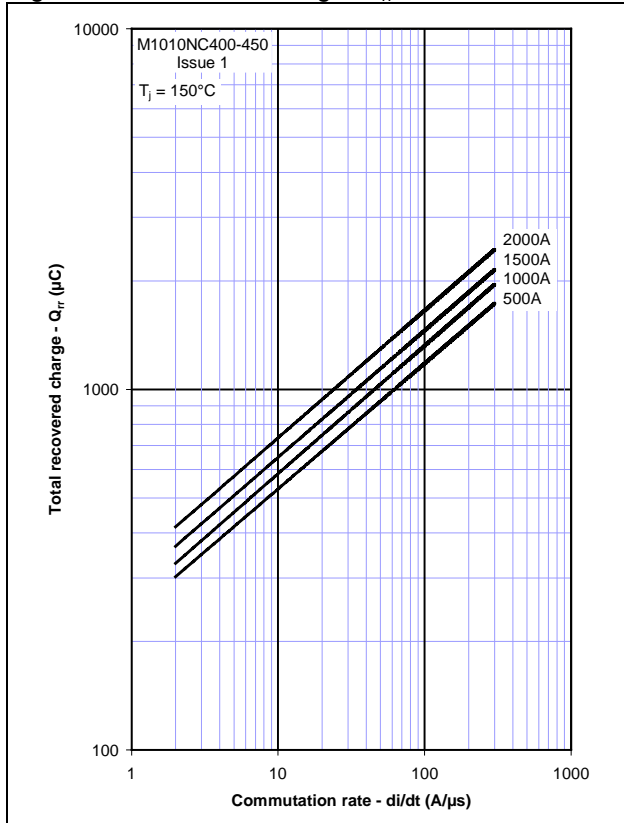

Figure 4 - Recovered charge, Q_{ra} (50% chord)

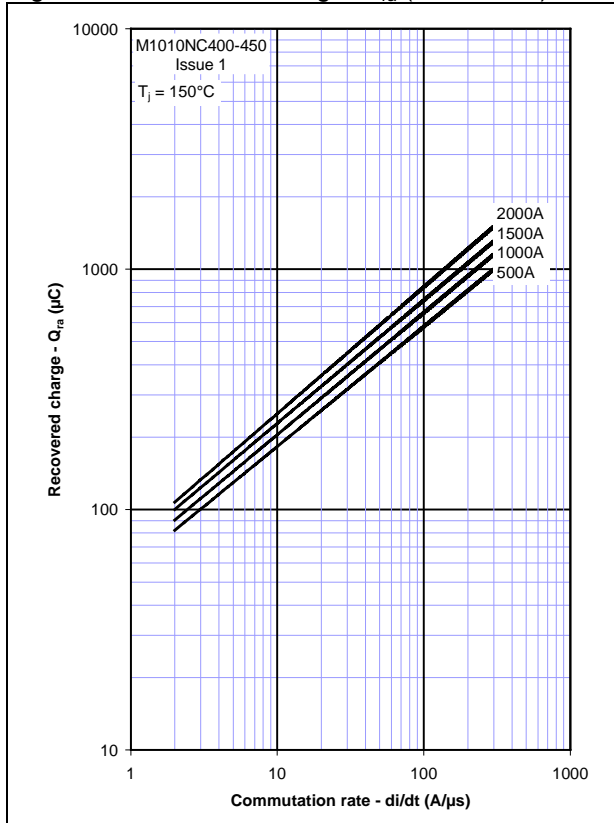

Figure 5 - Maximum reverse current, I_{rm}

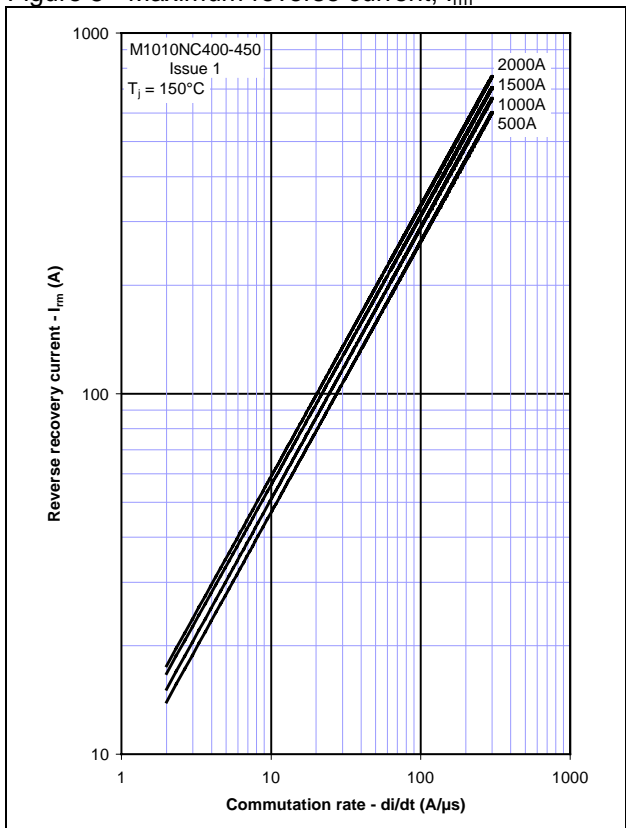

Figure 6 - Maximum recovery time, t_{rr} (50% chord)

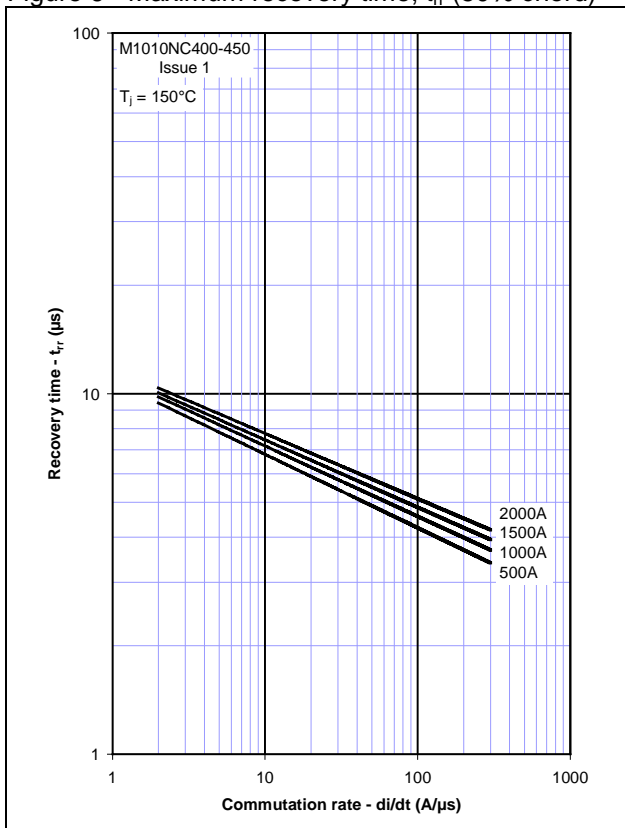

Figure 7 - Reverse recovery energy per pulse

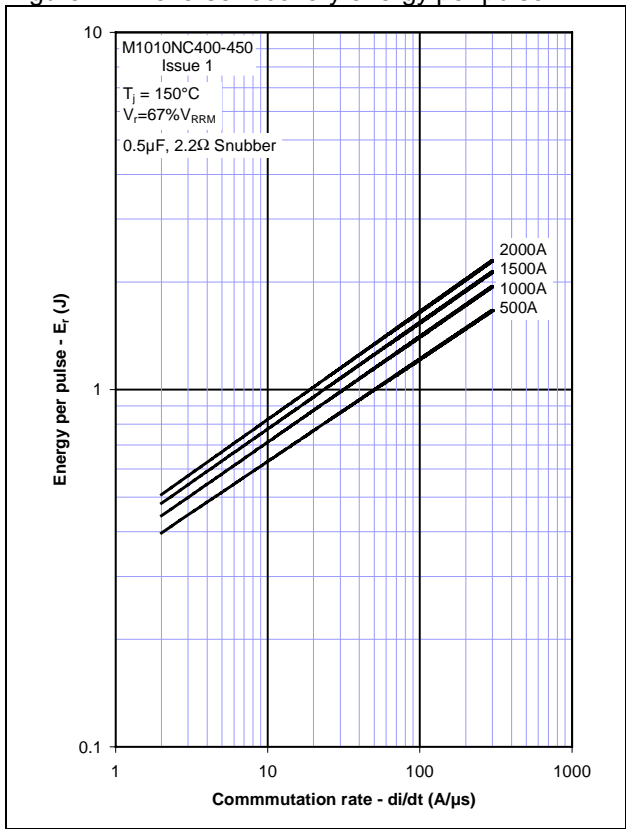

Figure 8 - Sine wave energy per pulse

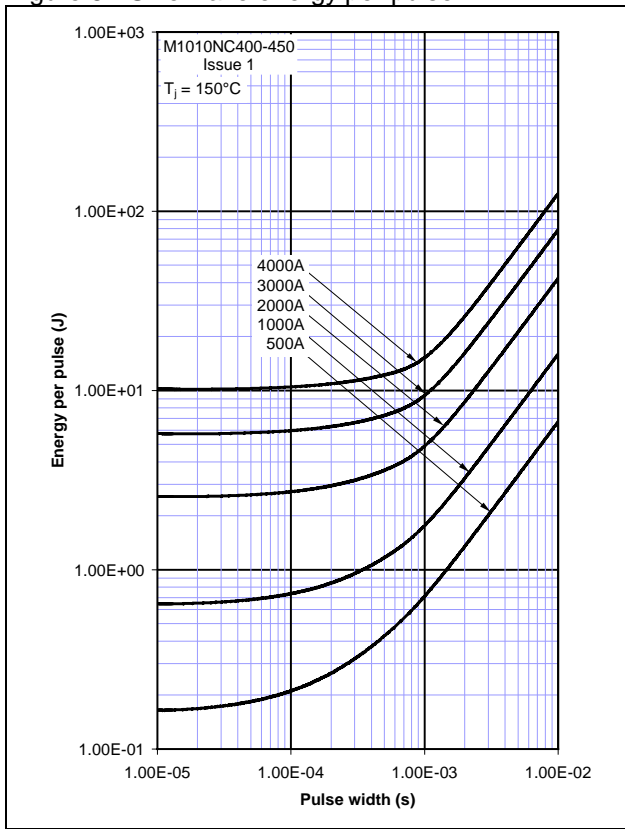

Figure 9 - Sine wave frequency vs. pulse width

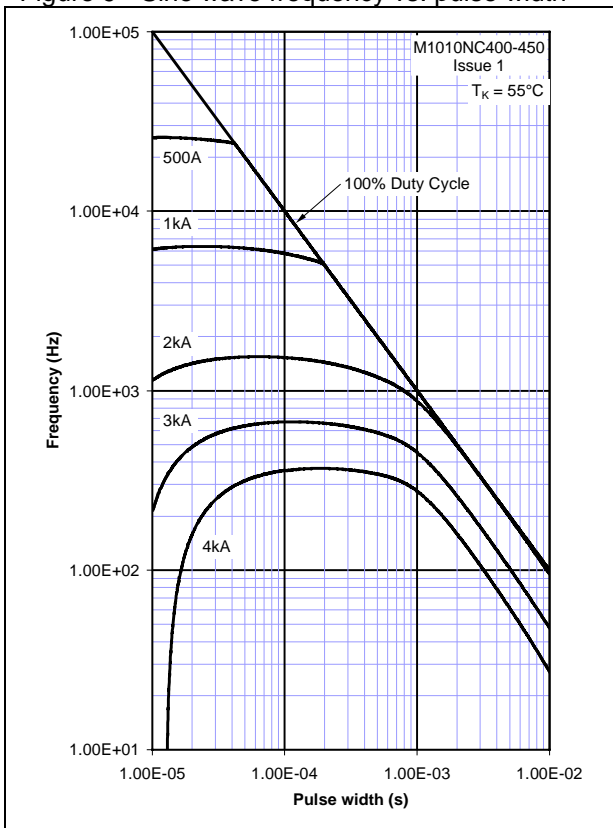

Figure 10 - Sine wave frequency vs. pulse width

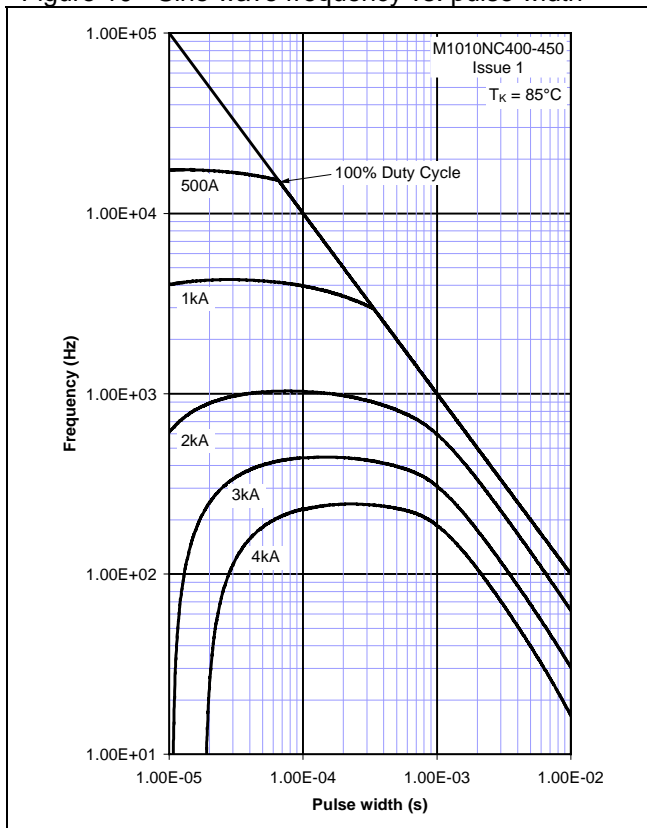

Figure 11 - Square wave energy per pulse

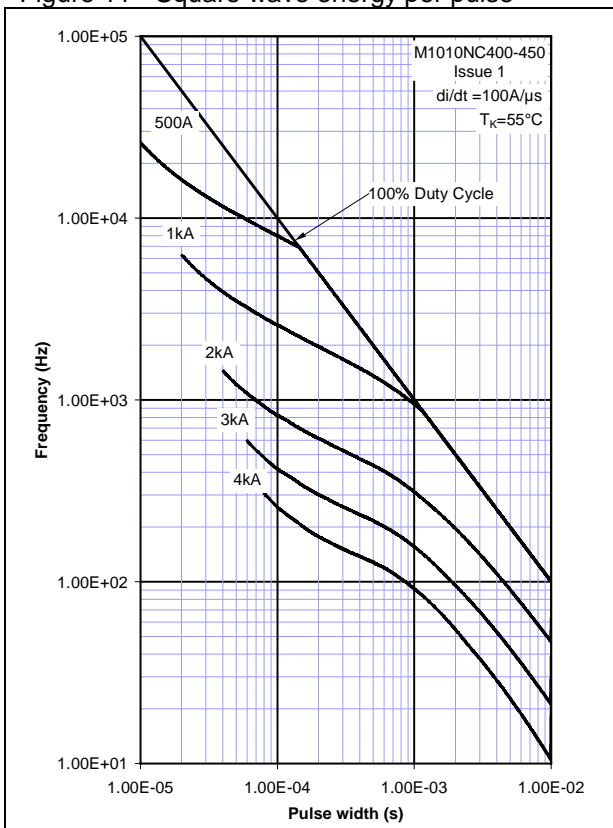

Figure 12 - Square wave energy per pulse

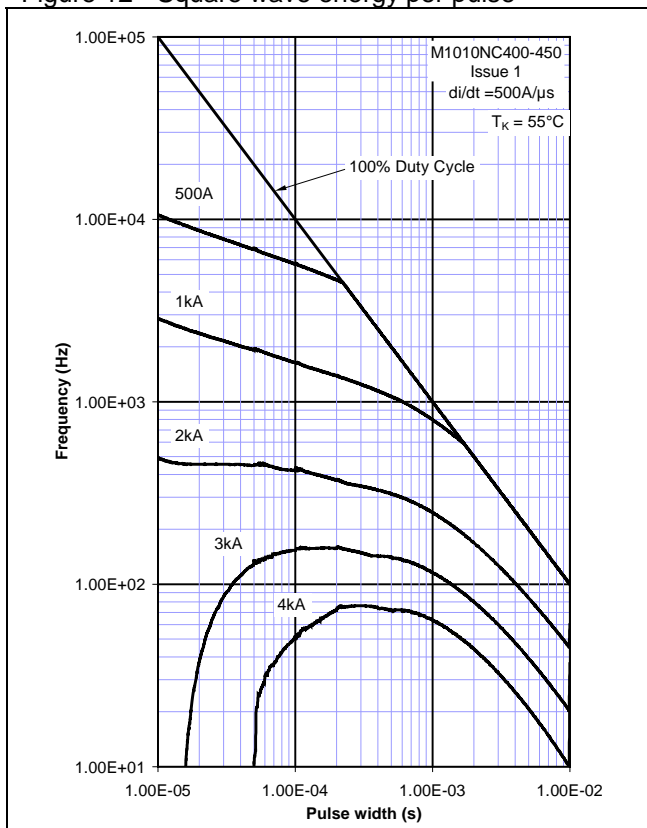

Figure 13 - Square wave frequency vs. pulse width

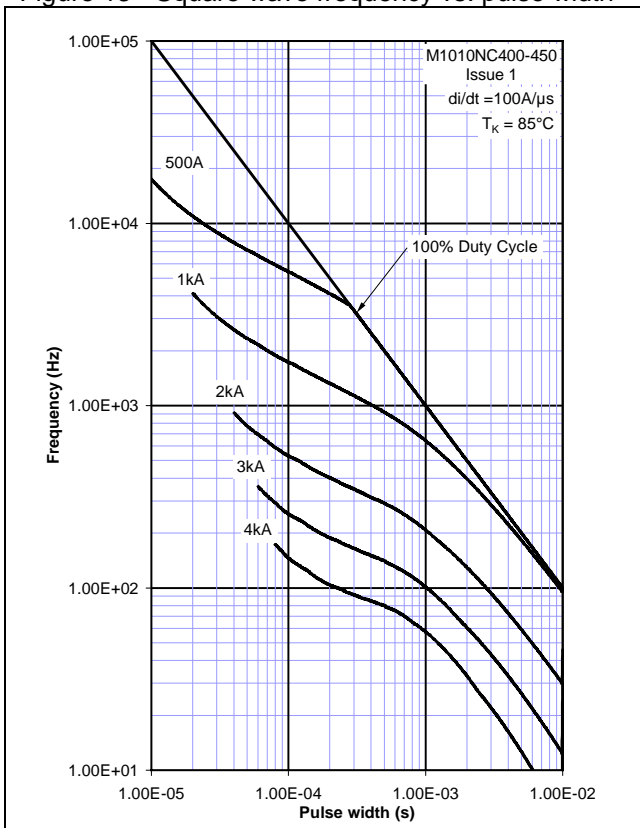

Figure 14 - Square wave frequency vs. pulse width

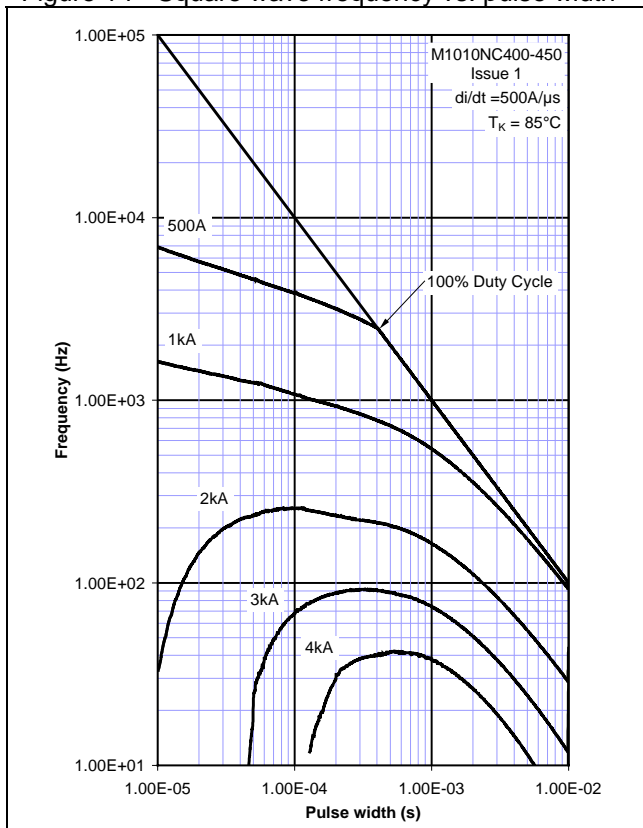

Figure 15 - Square wave frequency vs. pulse width

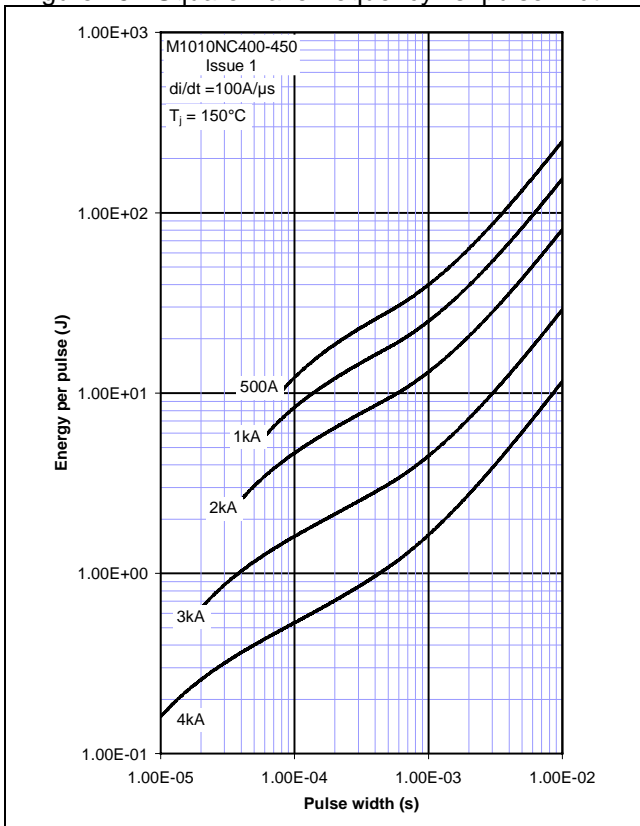

Figure 16 - Square wave frequency vs. pulse width

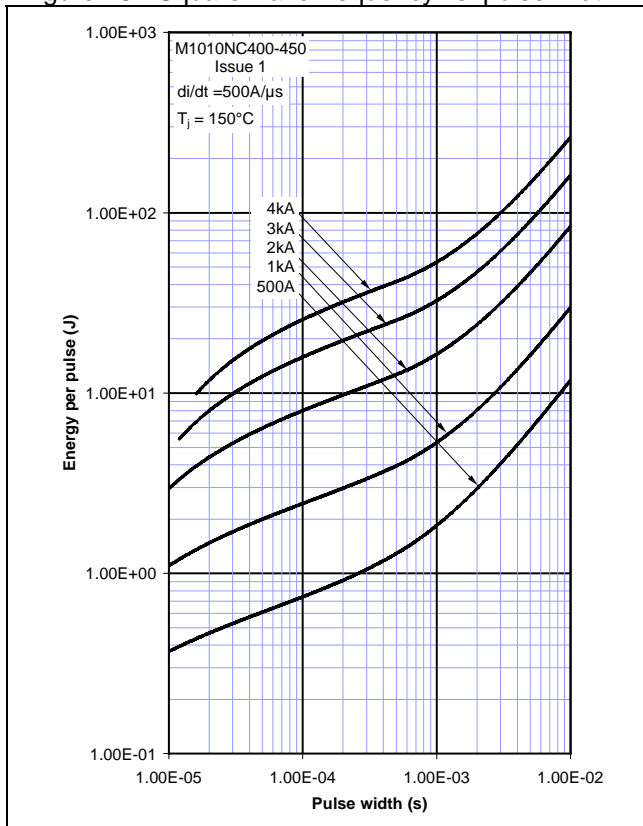

Figure 17 – Maximum surge and I^2t ratings

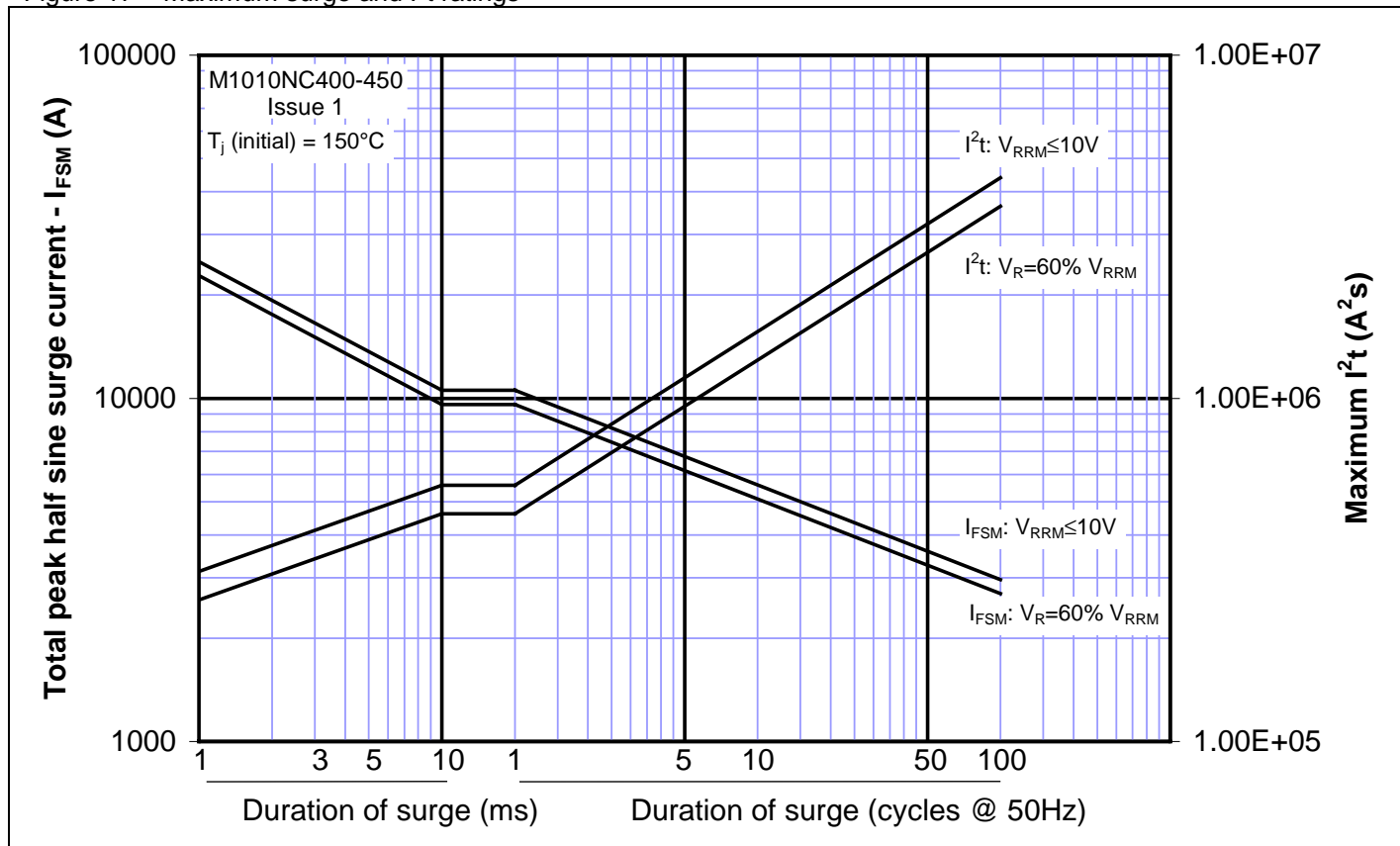
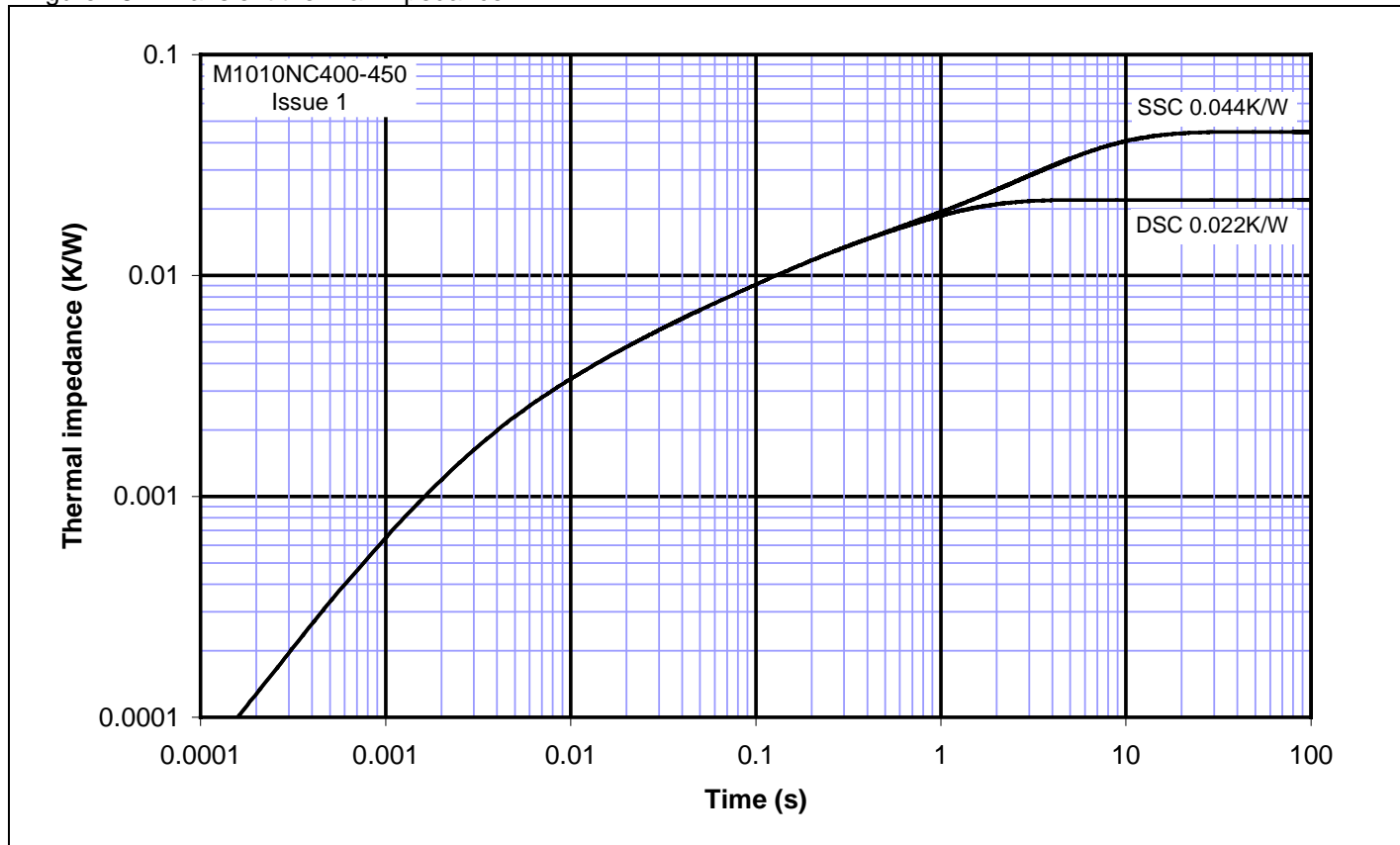
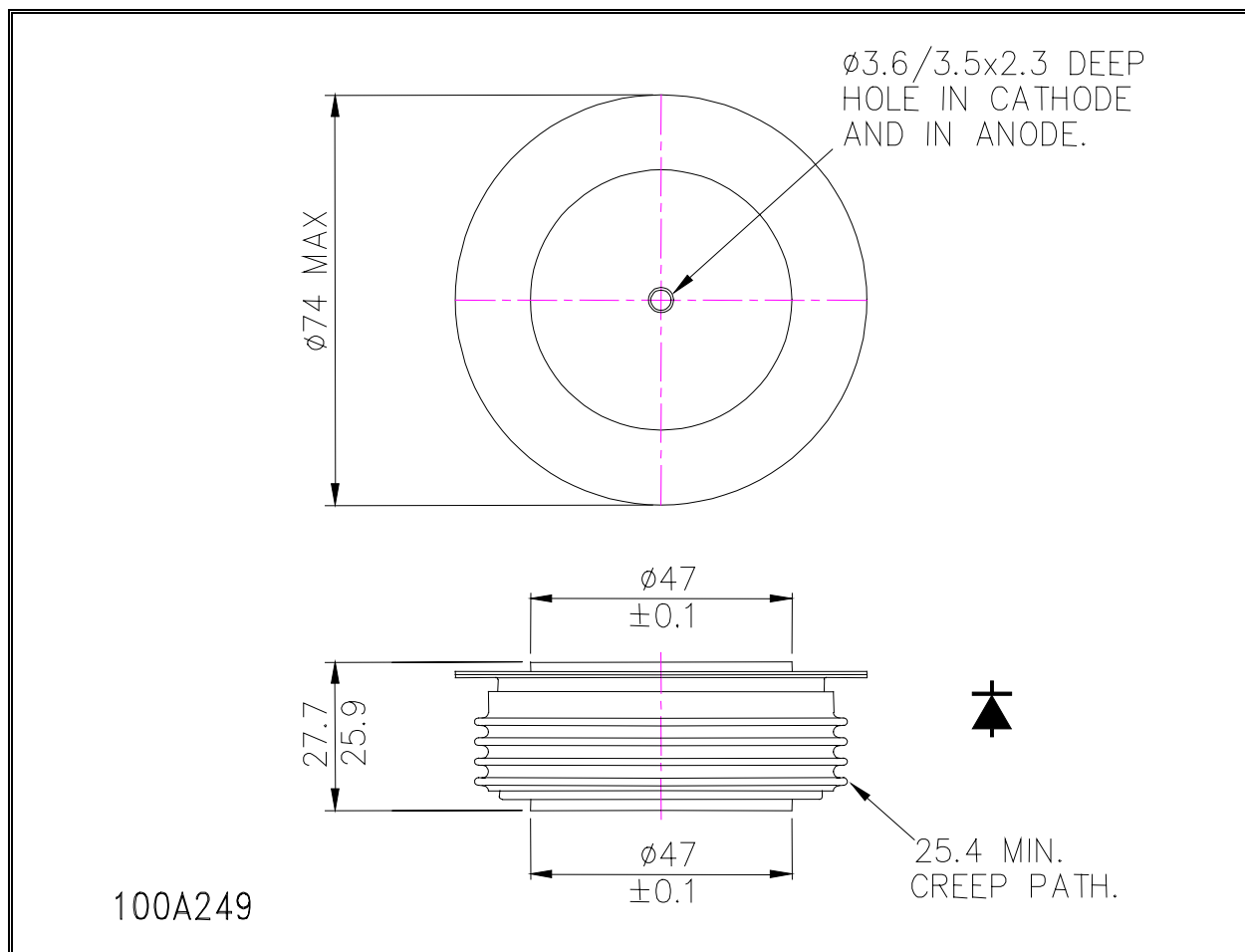

Figure 18 – Transient thermal impedance



Outline Drawing & Ordering Information



ORDERING INFORMATION			
(Please quote 10 digit code as below)			
M1010	NC	◆◆	0
Fixed Type Code	Fixed outline code	Voltage code $V_{DRM}/100$ 40-45	Fixed code

Order code: M1010NC420 – 4200V V_{RRM} , 27.7mm clamp height capsule.

IXYS Semiconductor GmbH
Edisonstraße 15
D-68623 Lampertheim
Tel: +49 6206 503-0
Fax: +49 6206 503-627
E-mail: marcom@ixys.de

WESTCODE

An IXYS Company

Westcode Semiconductors Ltd
Langley Park Way, Langley Park,
Chippenham, Wiltshire SN15 1GE.
Tel: +44 (0)1249 444524
Fax: +44 (0)1249 659448
E-mail: WSL.sales@westcode.com

IXYS Corporation
3540 Bassett Street
Santa Clara CA 95054 USA
Tel: +1 (408) 982 0700
Fax: +1 (408) 496 0670
E-mail: sales@ixys.net

www.westcode.com

www.ixys.com

Westcode Semiconductors Inc
3270 Cherry Avenue
Long Beach CA 90807 USA
Tel: +1 (562) 595 6971
Fax: +1 (562) 595 8182
E-mail: WSI.sales@westcode.com

The information contained herein is confidential and is protected by Copyright. The information may not be used or disclosed except with the written permission of and in the manner permitted by the proprietors Westcode Semiconductors Ltd.

© Westcode Semiconductors Ltd.

In the interest of product improvement, Westcode reserves the right to change specifications at any time without prior notice.

Devices with a suffix code (2-letter or letter/digit/letter combination) added to their generic code are not necessarily subject to the conditions and limits contained in this report.



Disclaimer Notice - Information furnished is believed to be accurate and reliable. However, users should independently evaluate the suitability of and test each product selected for their own applications. Littelfuse products are not designed for, and may not be used in, all applications. Read complete Disclaimer Notice at www.littelfuse.com/disclaimer-electronics.