

Provisional Data

High Power Sonic FRD Type E1500NH48P

Absolute Maximum Ratings

	VOLTAGE RATINGS	MAXIMUM LIMITS	UNITS
V_{RRM}	Repetitive peak reverse voltage (note 1)	4800	V
V_{RSM}	Non-repetitive peak reverse voltage (note 1)	4900	V
$V_{R(d.c.)}$	Maximum reverse d.c. voltage (note 1)	2800	V

	OTHER RATINGS (note 6)	MAXIMUM LIMITS	UNITS
$I_{F(AV)M}$	Mean forward current, $T_{sink}=55^{\circ}C$ (note 2)	1280	A
$I_{F(AV)M}$	Mean forward current. $T_{sink}=100^{\circ}C$ (note 2)	780	A
$I_{F(AV)M}$	Mean forward current. $T_{sink}=100^{\circ}C$ (note 3)	480	A
$I_{F(RMS)}$	Nominal RMS forward current, $T_{sink}=25^{\circ}C$ (note 2)	2375	A
$I_{F(d.c.)}$	D.C. forward current, $T_{sink}=25^{\circ}C$ (note 4)	2125	A
I_{FSM}	Peak non-repetitive surge $t_p=10ms$, $V_{RM}=60\%V_{RRM}$ (note 5)	17050	A
I_{FSM2}	Peak non-repetitive surge $t_p=10ms$, $V_{RM}\leq 10V$ (note 5)	18750	A
I^2t	I^2t capacity for fusing $t_p=10ms$, $V_{RM}=60\%V_{RRM}$ (note 5)	1.45×10^6	A^2s
I^2t	I^2t capacity for fusing $t_p=10ms$, $V_{RM}\leq 10V$ (note 5)	1.76×10^6	A^2s
$T_{j\ op}$	Operating temperature range	-40 to +140	$^{\circ}C$
T_{stg}	Storage temperature range	-40 to +140	$^{\circ}C$

Notes:-

- 1) De-rating factor of 0.13% per $^{\circ}C$ is applicable for T_j below $25^{\circ}C$.
- 2) Double side cooled, single phase; 50Hz, 180° half-sinewave.
- 3) Single side cooled, single phase; 50Hz, 180° half-sinewave.
- 4) Double side cooled.
- 5) Half-sinewave, $140^{\circ}C$ T_j initial.
- 6) Current (I_F) ratings have been calculated using V_{T0} and r_T (see page 2)

Characteristics

	PARAMETER	MIN.	TYP.	MAX.	TEST CONDITIONS (Note 1)	UNITS
V _{FM}	Maximum peak forward voltage	-	1.9	2.1	I _{FM} =1500A, T _j =25°C	V
		-	2.2	2.4	I _{FM} =1500A	
		-	2.9	3.1	I _{FM} =3000A	
V _{T0}	Threshold voltage	-	-	1.417	Current range 600A-1500A (Note 2)	V
r _T	Slope resistance	-	-	0.656		mΩ
V _{FRM}	Maximum forward recovery voltage	-	-	60	di/dt = 1000A/μs, T _j =25°C	V
		-	-	120	di/dt = 1000A/μs	
I _{RRM}	Peak reverse current	-	-	10	Rated V _{RRM} , T _j =25°C	mA
		-	-	80	Rated V _{RRM}	
Q _{rr}	Recovered charge	-	2750	-	I _{FM} =1000A, t _p =1ms, di/dt=1000A/μs, V _r =500V, 50% Chord. (note 3)	μC
Q _{ra}	Recovered charge	-	1880	2210		μC
I _{rm}	Reverse recovery current	-	1425	-		A
t _{rr}	Reverse recovery time, 50% Chord	-	2.8	-		μs
Q _{rr}	Recovered charge	-	935	-	I _{FM} =1350A, t _p =1000μs, di/dt=200A/μs, V _r =100V, 50% Chord.	μC
Q _{ra}	Recovered charge	-	635	760		μC
I _{rm}	Reverse recovery current	-	390	-		A
t _{rr}	Reverse recovery time, 50% Chord	-	3.2	-		μs
R _{thJK}	Thermal resistance, junction to heatsink	-	-	0.019	Double side cooled	K/W
t _{rr}	Reverse recovery time	-	-	0.038	Single side cooled	μs
F	Mounting force	19	-	26	(Note 4)	kN
W _t	Weight	-	250	-		g

Notes:-

- 1) Unless otherwise indicated T_j=140°C.
- 2) V_{T0} and r_T were used to calculate the current ratings illustrated on page one.
- 3) Figures 3-7 were compiled using these conditions.
- 4) For clamp forces outside these limits, please consult factory.

Notes on Ratings and Characteristics

1.0 De-rating Factor

A blocking voltage de-rating factor of 0.13% per °C is applicable to this device for T_j below 25°C.

2.0 ABCD Constants

These constants (applicable only over current range of V_F characteristic in Figure 1) are the coefficients of the expression for the forward characteristic given below:

$$V_F = A + B \cdot \ln(I_F) + C \cdot I_F + D \cdot \sqrt{I_F}$$

where I_F = instantaneous forward current.

3.0 Reverse recovery ratings

(i) Q_{rra} is based on 50% I_{rm} chord as shown in the figure below.

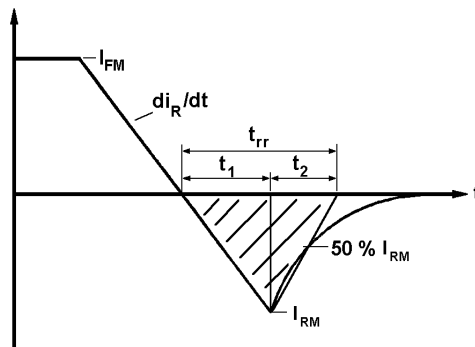

(ii) Q_{rr} is based on a 150µs integration time.

i.e.

$$Q_{rr} = \int_0^{150\mu s} i_{rr} \cdot dt$$

(iii)

$$K \text{ Factor} = \frac{t_1}{t_2}$$

4.0 Reverse Recovery Loss

The following procedure is recommended for use where it is necessary to include reverse recovery loss.

From waveforms of recovery current obtained from a high frequency shunt (see Note 1) and reverse voltage present during recovery, an instantaneous reverse recovery loss waveform must be constructed. Let the area under this waveform be E joules per pulse. A new sink temperature can then be evaluated from:

$$T_K = T_{j(MAX)} - E \cdot [k + f \cdot R_{thJK}]$$

Where k = 0.2314 (°C/W)/s

E = Area under reverse loss waveform per pulse in joules (W.s.)

f = Rated frequency in Hz at the original sink temperature.

R_{thJK} = d.c. thermal resistance (°C/W)

The total dissipation is now given by:

$$W_{(tot)} = W_{(original)} + E \cdot f$$

NOTE 1 - Reverse Recovery Loss by Measurement

This device has a low reverse recovered charge and peak reverse recovery current. When measuring the charge, care must be taken to ensure that:

(a) AC coupled devices such as current transformers are not affected by prior passage of high amplitude forward current.

(b) A suitable, polarised, clipping circuit must be connected to the input of the measuring oscilloscope to avoid overloading the internal amplifiers by the relatively high amplitude forward current signal.

(c) Measurement of reverse recovery waveform should be carried out with an appropriate critically damped snubber, connected across diode anode to cathode. The formula used for the calculation of this snubber is shown below:

$$R^2 = 4 \cdot \frac{V_r}{C_s \cdot di/dt}$$

Where: V_r = Commutating source voltage

C_s = Snubber capacitance

R = Snubber resistance

5.0 Computer Modelling Parameters

5.1 Device Dissipation Calculations

$$I_{AV} = \frac{-V_{T0} + \sqrt{V_{T0}^2 + 4 \cdot ff^2 \cdot r_T \cdot W_{AV}}}{2 \cdot ff^2 \cdot r_T}$$

Where $V_{T0} = 1.417V$, $r_T = 0.656m\Omega$

ff = form factor (normally unity for fast diode applications)

$$W_{AV} = \frac{\Delta T}{R_{th}}$$

$$\Delta T = T_{j(MAX)} - T_K$$

5.2 Calculation of V_F using ABCD Coefficients

The forward characteristic I_F Vs V_F , on page 6 is represented in two ways;

- (i) the well established V_{T0} and r_T tangent used for rating purposes and
- (ii) a set of constants A, B, C, and D forming the coefficients of the representative equation for V_F in terms of I_F given below:

$$V_F = A + B \cdot \ln(I_F) + C \cdot I_F + D \cdot \sqrt{I_F}$$

The constants, derived by curve fitting software, are given in this report for both hot and cold characteristics. The resulting values for V_F agree with the true device characteristic over a current range, which is limited to that plotted.

25°C Coefficients		150°C Coefficients	
A	1.244726	A	1.340995
B	-0.06647227	B	-0.1059655
C	3.417340×10^{-6}	C	3.735374×10^{-5}
D	0.03402272	D	0.04593112

Curves

Figure 1 – Forward characteristics of Limit device

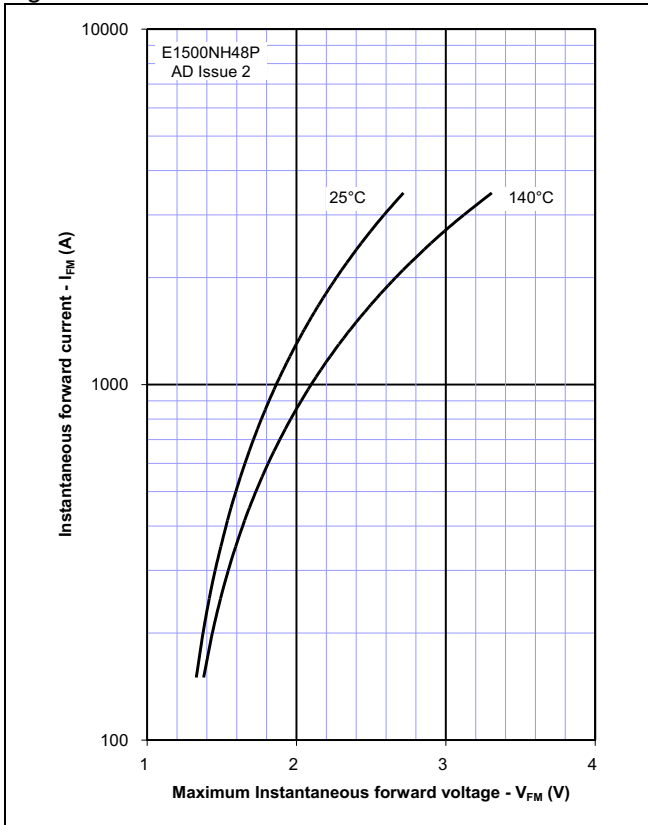

Figure 2 – Maximum forward recovery voltage

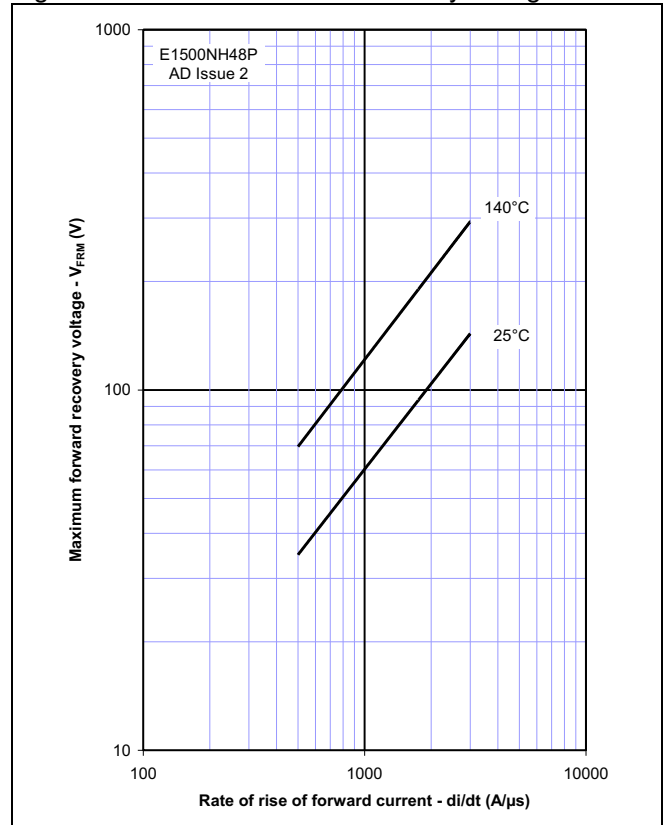

Figure 3 – Recovered charge, Q_{rr}

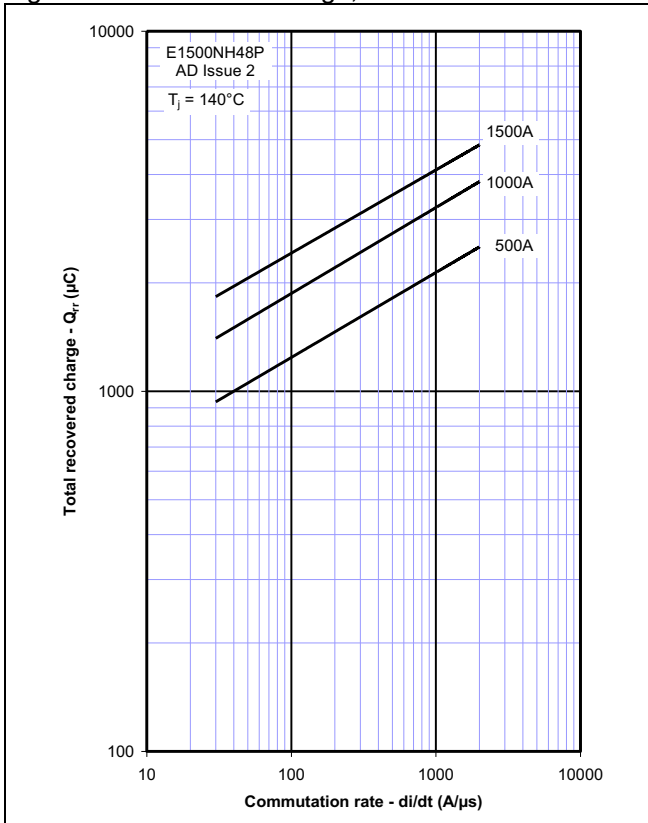

Figure 4 – Recovered charge, Q_{ra} (50% chord)

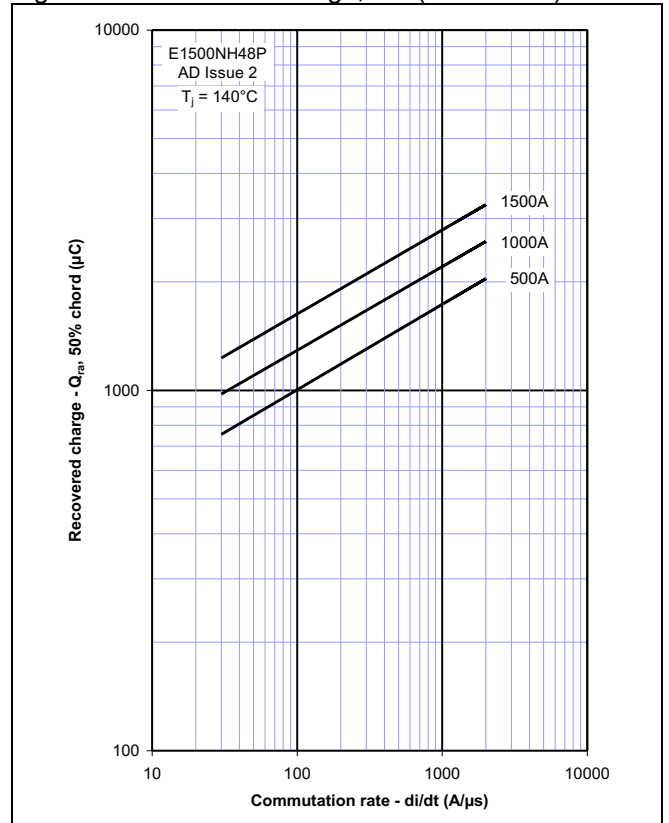

Figure 5 – Reverse recovery current, I_{rm}

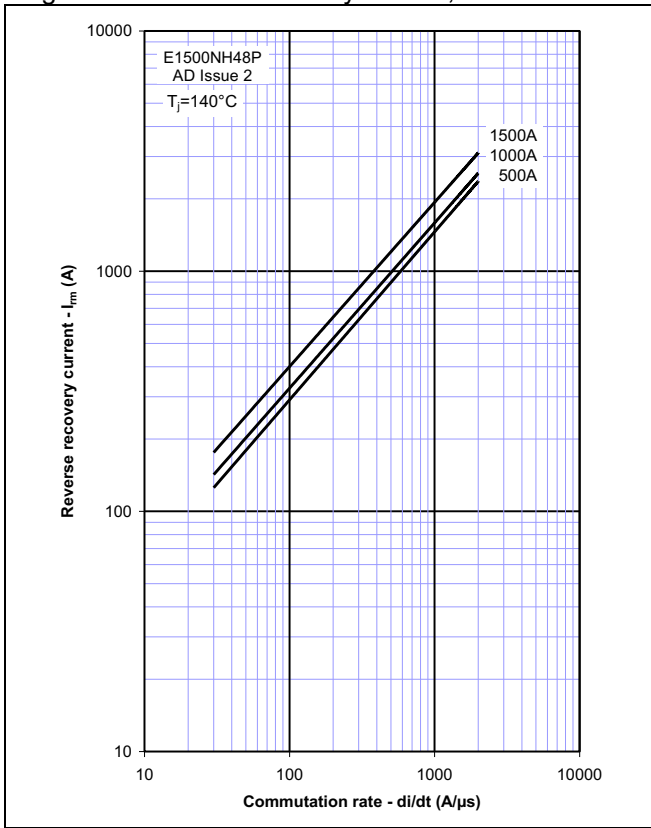

Figure 6 – Reverse recovery time, t_{rr} (50% chord)

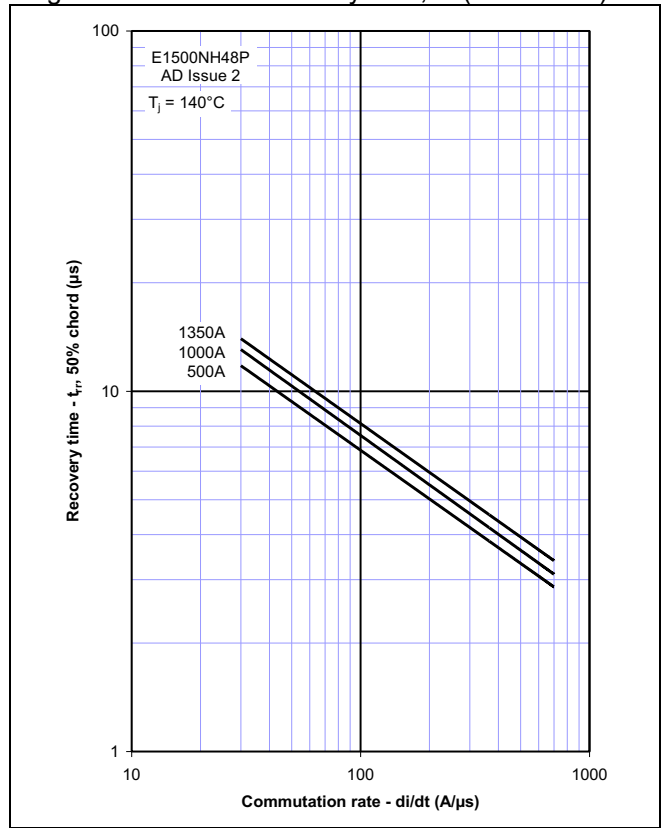

Figure 7 – Reverse recovery energy per pulse

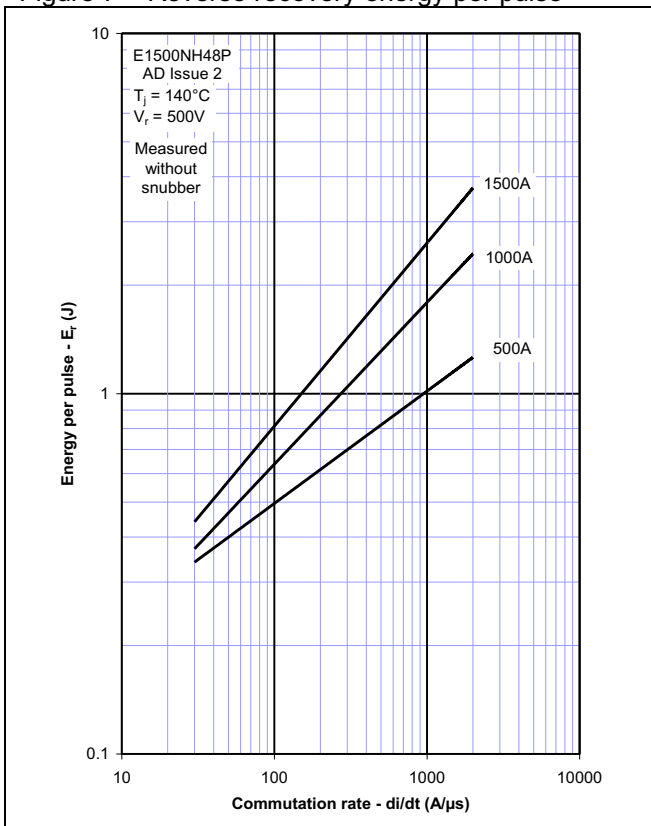

Figure 8 – Sine wave energy per pulse

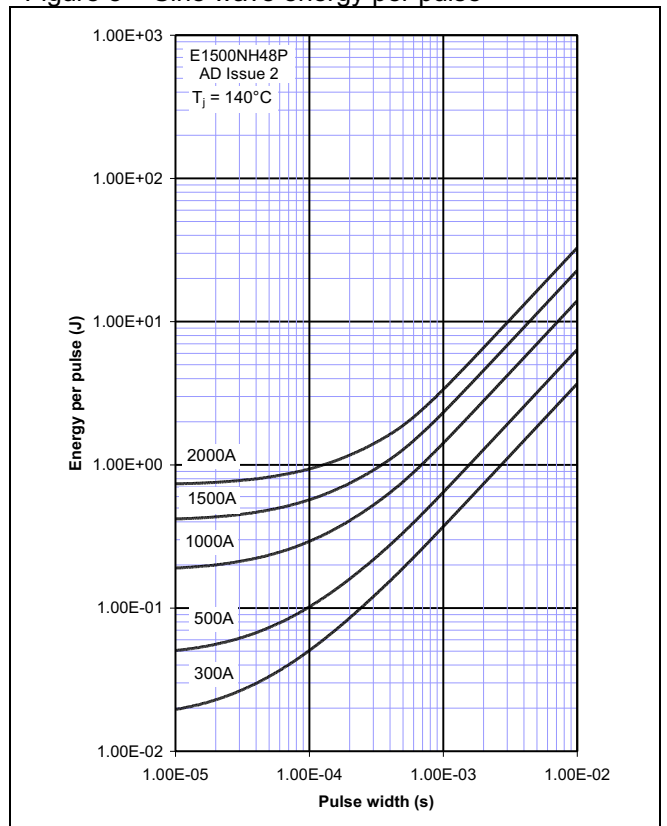

Figure 9 – Sine wave frequency vs. pulse width

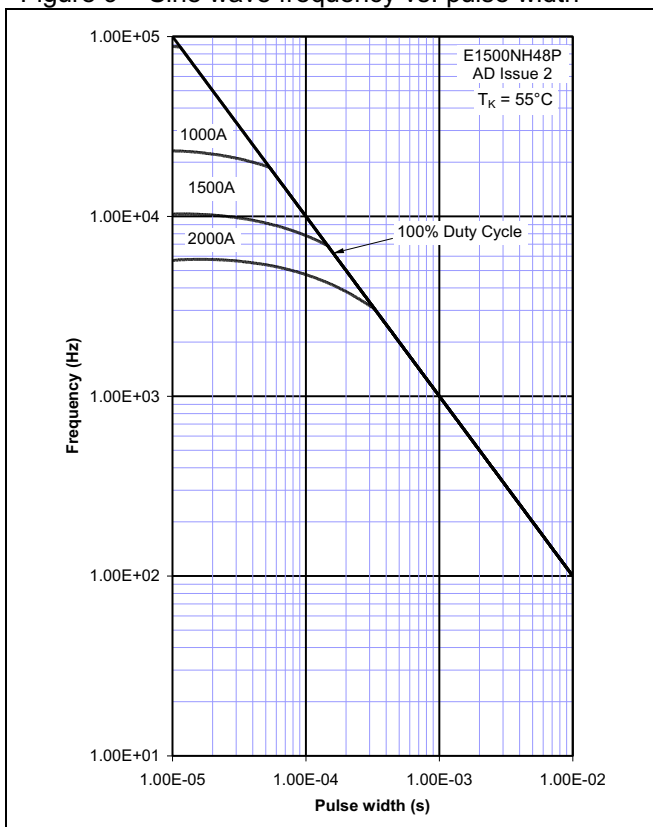

Figure 10 – Sine wave frequency vs. pulse width

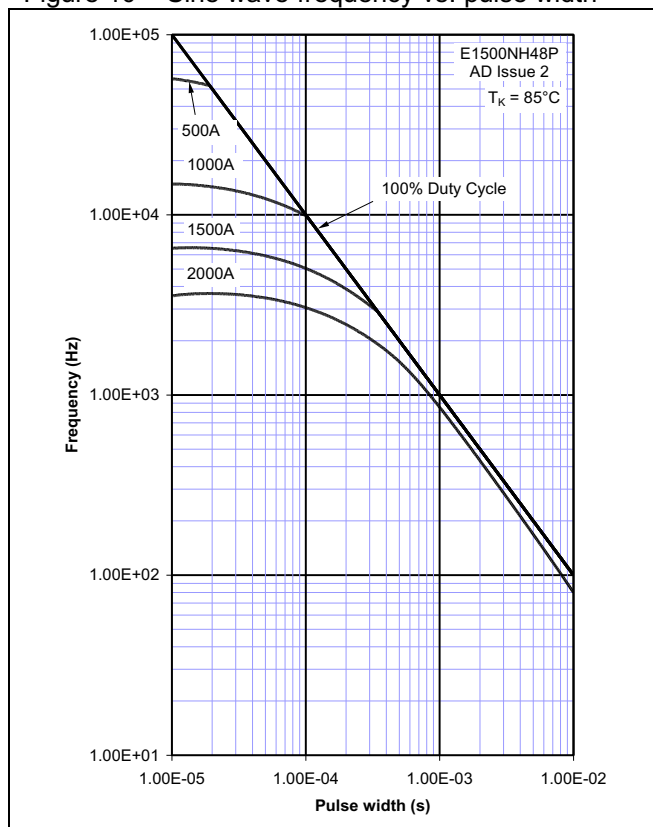

Figure 11 – Square wave energy per pulse

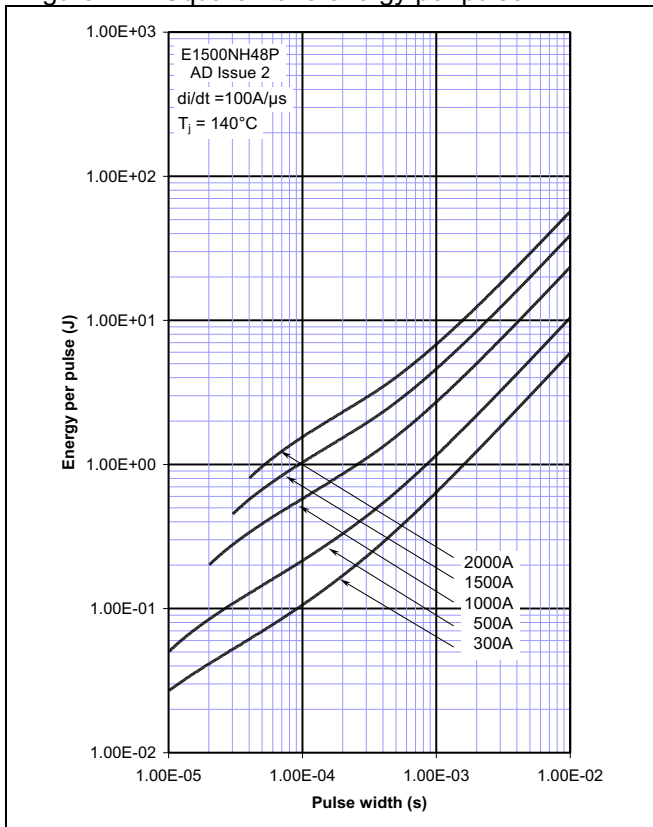

Figure 12 – Square wave energy per pulse

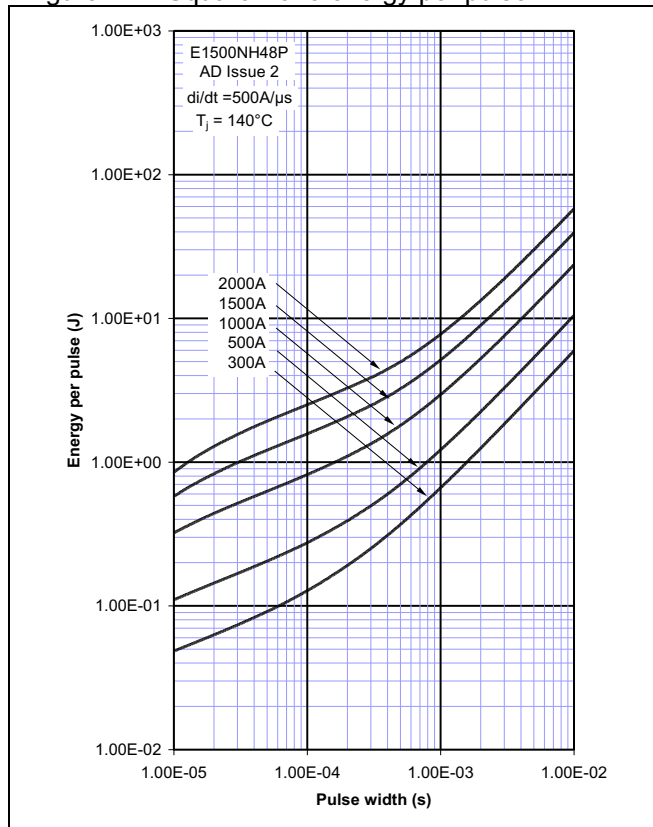

Figure 13 – Square wave frequency vs pulse width

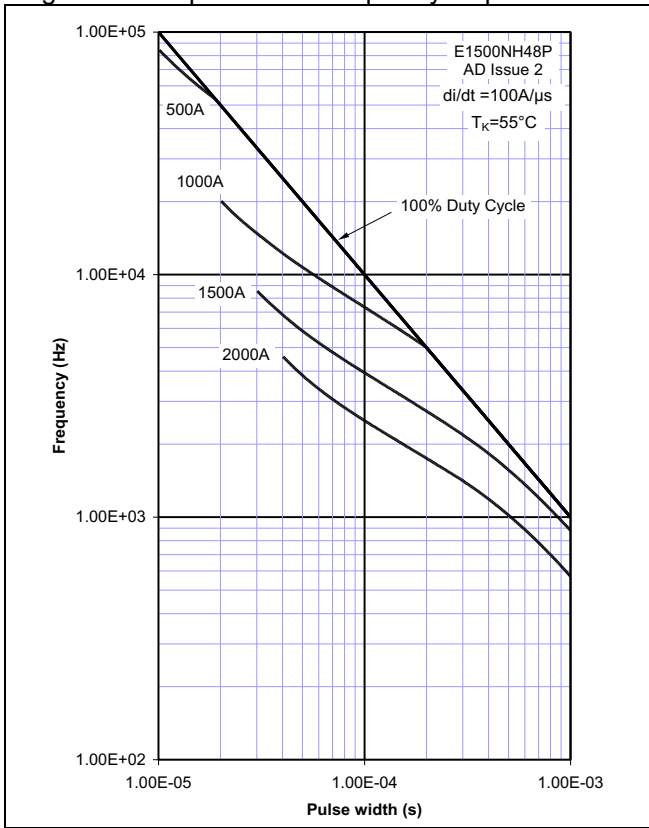

Figure 14 – Square wave frequency vs pulse width

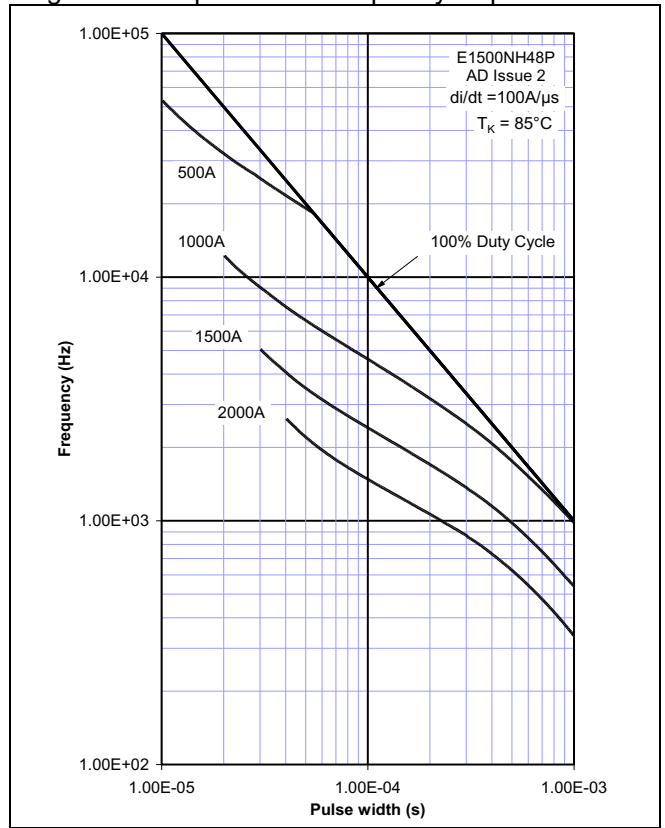

Figure 15 – Square wave frequency vs pulse width

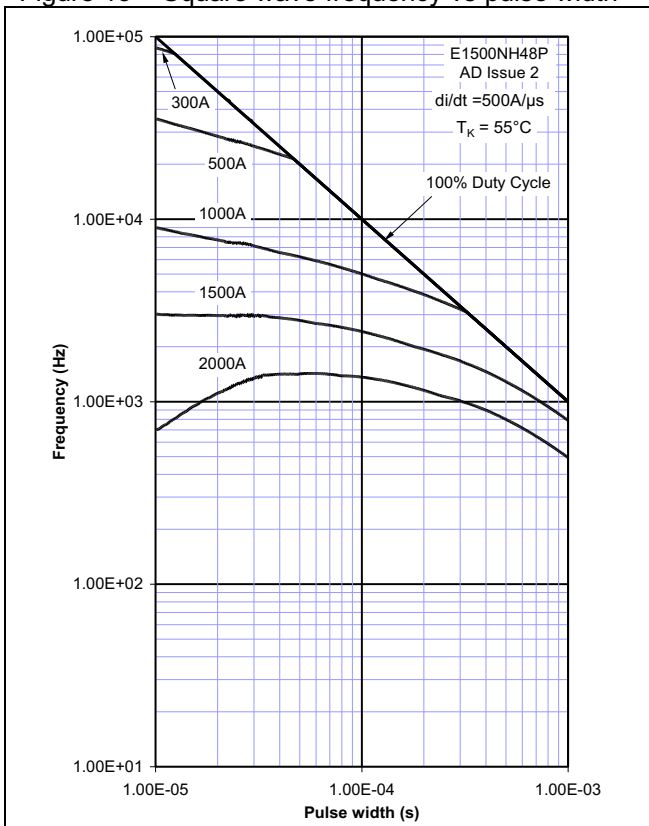

Figure 16 – Square wave frequency vs pulse width

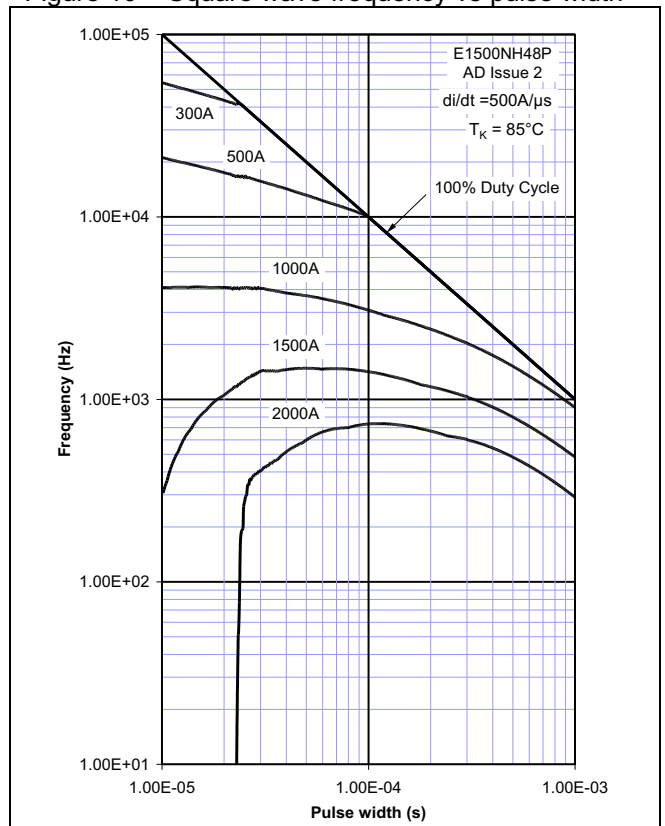

Figure 17 – Safe operating area

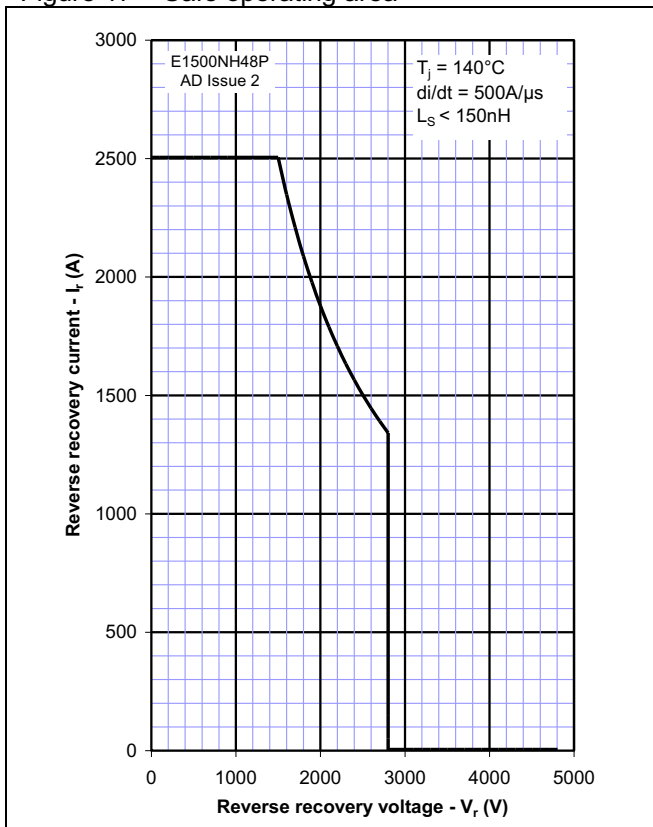

Figure 18 – Transient thermal impedance

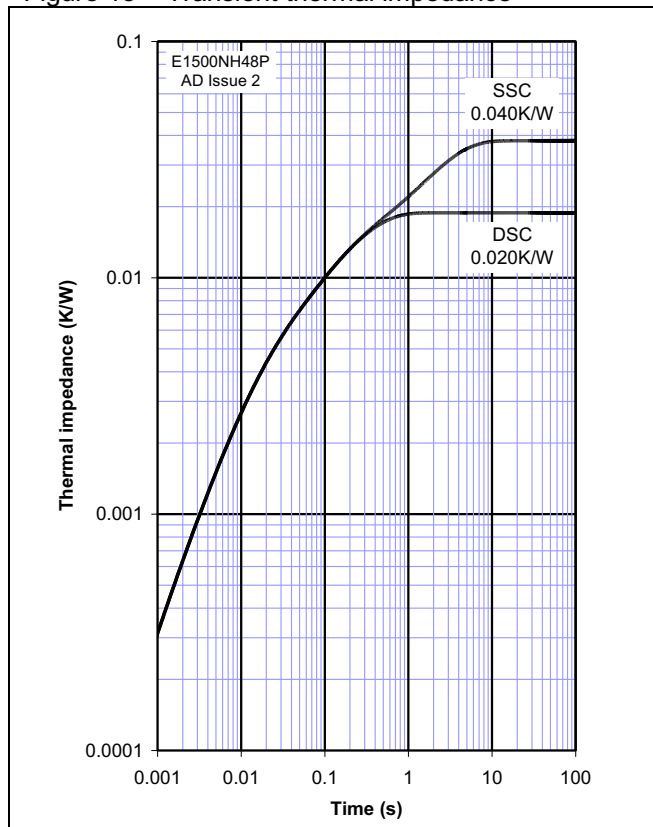
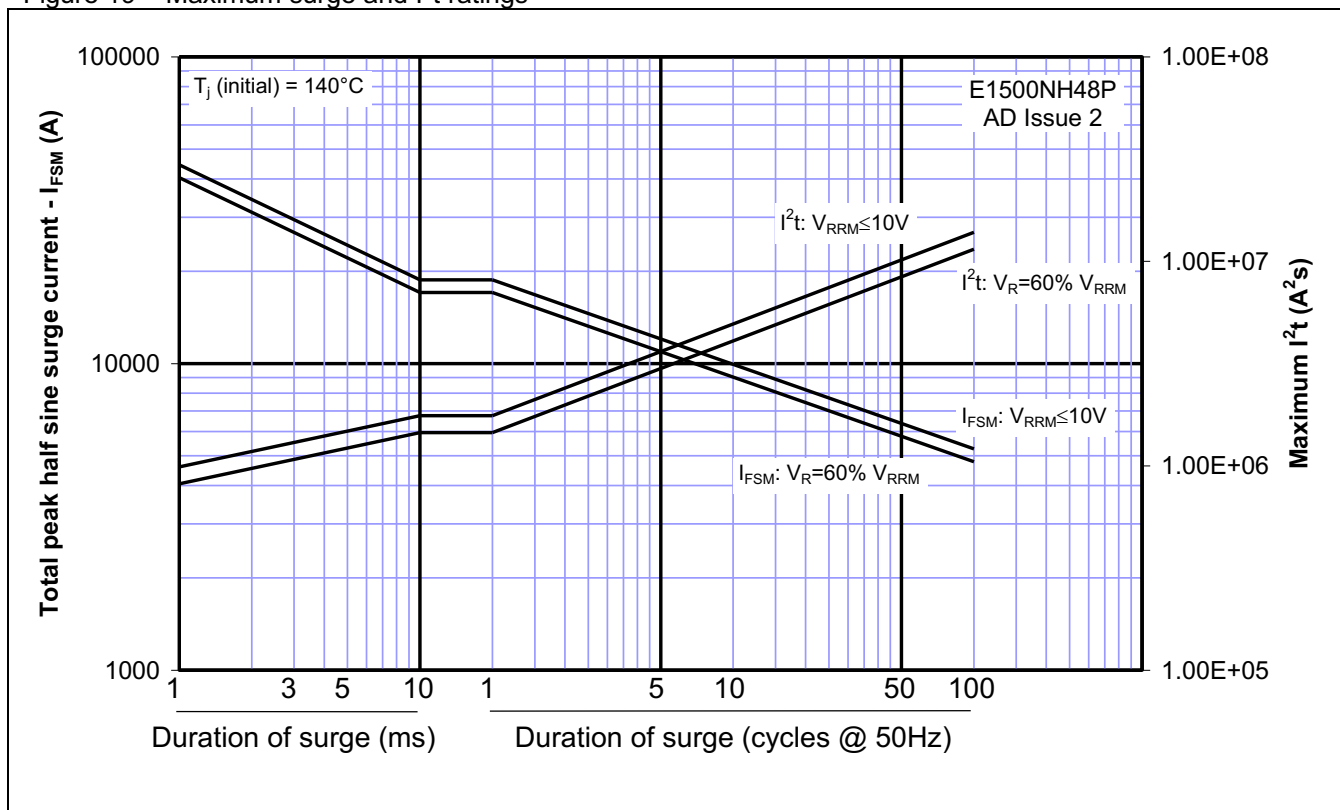
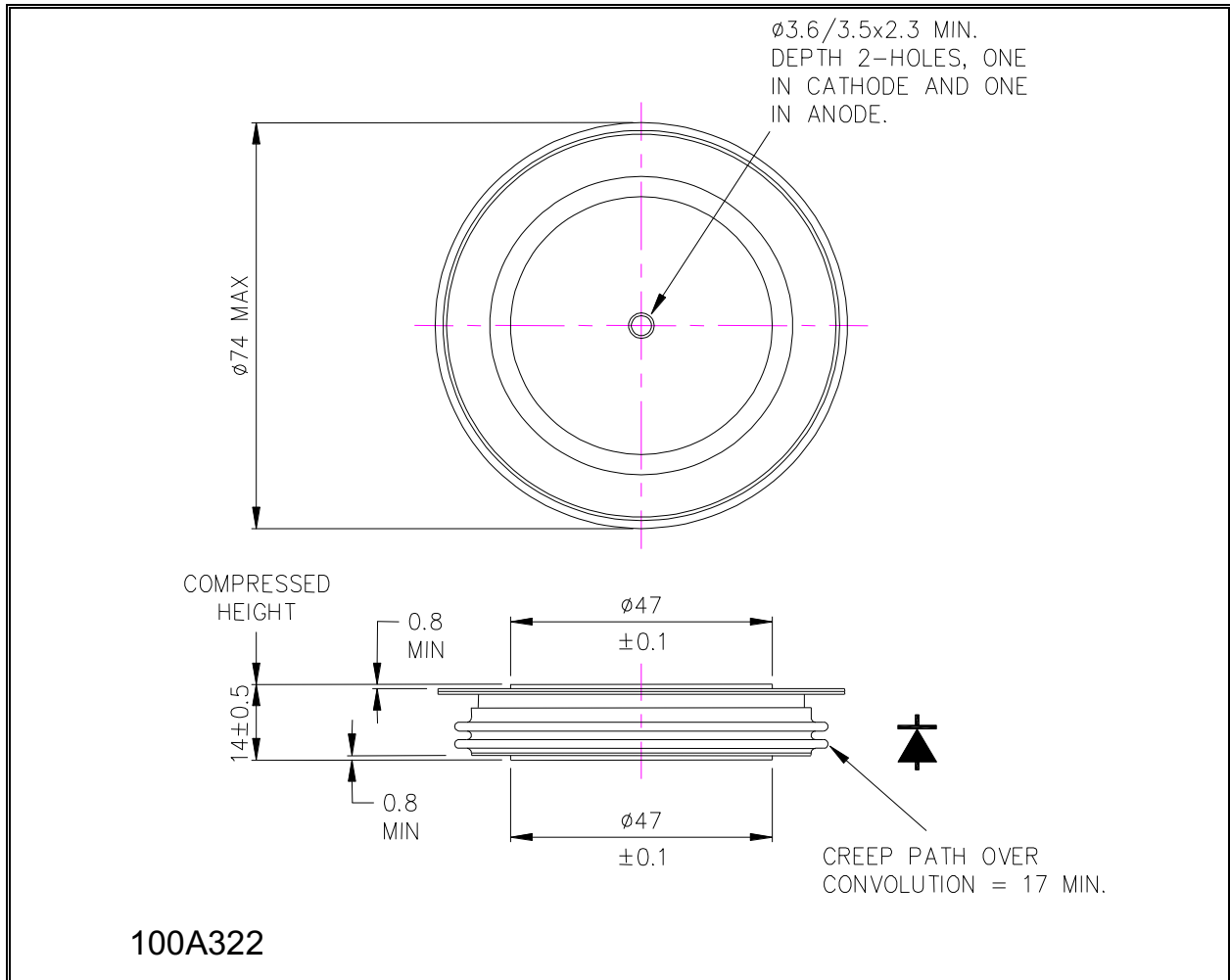

Figure 19 – Maximum surge and I^2t ratings



Outline Drawing & Ordering Information



ORDERING INFORMATION		(Please quote 10 digit code as below)	
E1500	NH	◆ ◆	P
Fixed Type Code	Fixed outline code	Voltage code $V_{RRM}/100$ 48	Fixed code

Typical order code: E1500NH48P – 4800V V_{RRM} , 14mm clamp height capsule.

IXYS Semiconductor GmbH
 Edisonstraße 15,
 D-68623 Lampertheim
 Tel: +49 6206 503-0
 Fax: +49 6206 503-627
 E-mail: marcom@ixys.de

WESTCODE

An IXYS Company

Westcode Semiconductors Ltd
 PO Box 57, Chippenham,
 Wiltshire, SN15 1JL.
 Tel: +44 (0)1249 444524
 Fax: +44 (0)1249 659448
 E-mail: WSL.sales@westcode.com

IXYS Corporation
 3540 Bassett Street,
 Santa Clara, CA 95054, USA
 Tel: +1 (408) 982 0700
 Fax: +1 (408) 496 0670
 E-mail: sales@ixys.com

www.westcode.com

www.ixys.com

Westcode Semiconductors Inc
 3270 Cherry Avenue,
 Long Beach, CA 90807, USA
 Tel: +1 (562) 595 6971
 Fax: +1 (562) 595 8182
 E-mail: WSI.sales@westcode.com

The information contained herein is confidential and is protected by Copyright. The information may not be used or disclosed except with the written permission of and in the manner permitted by the proprietors Westcode Semiconductors Ltd.

© Westcode Semiconductors Ltd.

In the interest of product improvement, Westcode reserves the right to change specifications at any time without prior notice.

Devices with a suffix code (2-letter, 3-letter or letter/digit/letter combination) added to their generic code are not necessarily subject to the conditions and limits contained in this report.



Disclaimer Notice - Information furnished is believed to be accurate and reliable. However, users should independently evaluate the suitability of and test each product selected for their own applications. Littelfuse products are not designed for, and may not be used in, all applications. Read complete Disclaimer Notice at www.littelfuse.com/disclaimer-electronics.