

DCNEV150 SERIES HIGH CURRENT HIGH VOLTAGE DC CONTACTOR RELAY



Description

High current and high voltage DC contactor relays for electric vehicle applications such as battery power supply, DC power control, circuit protection, and other switch controls. Can also be used in uninterruptible power supply and other electronic control systems. Available with polarized and non-polarized contacts to best suit electrical systems' polarity. Coil Economizer greatly reduces coil power and heating after the contactor is energized. Once the contactor is energized, it takes minimal coil power to keep the contacts closed due to Pulse Width Modulation (PWM) reducing the average power delivered by pulsing the electrical signal.

Applications

- Battery Electric Vehicles
- Hybrid Electric Vehicles
- Material Handling
- Electric Maintenance and Transport Vehicles
- Industrial Applications

Specifications Overview

Amperage:	150A Continuous Carry
Housing:	Nylon UL 94-V0
Voltage Rating:	900V
Output Connectors:	M8 x 1.25 High Current Connections
Connectors:	Wire Leads for Control Circuit
Ingress Protections:	IP67
Operating Temperature:	-40°C to 85°C
Circuitry:	SPST NO
Working Voltage:	9-36V DC
Max Coil Inrush Current:	3.8A
Mounting:	#10 with Compression Limiters
Size:	Reference Dimensions on Page 2
Mounting Bolt Torque:	1.7 - 3.3 Nm (15- 30 in-lb)
Contact Torque:	8.8 - 11 Nm (80-100 in-lb)
Terminals:	M8 Silver Plated Copper
Approvals:	UL File No. E510407 Recognized

Features and Benefits

- High current (150A) and high voltage (900V) contactor for EV Applications
- Compact structure, helping reduce noise when turned on
- Coil Economizer greatly reduces coil power and heating
- Sealed IP67, gas-filled relay which mitigates arcing
- No mounting orientation restrictions
- Designed and manufactured under the IATF16949 certification for Automotive Quality Systems.
- Designed specifically for automotive applications.

Web Resources

Download 2D print and technical resources at:
littelfuse.com/DCNEV150

Ordering Information

PART NUMBER	DESCRIPTION	COIL VOLTAGE 12-24V DC	AUXILIARY CONTACT SPST-NO	BOTTOM MOUNT	NON-POLARIZED TERMINALS
DCNEV150-M	High Voltage DC Contactor Relay Bottom Mount with Polar Load Terminals	●		●	
DCNEV150-MA	High Voltage DC Contactor Relay Bottom Mount with Auxiliary Circuit with Polar Load Terminals	●	●	●	
DCNEV150-MAN	High Voltage DC Contactor Relay Bottom Mount With Auxiliary Circuit & Non-Polar Load Terminals	●	●	●	●
DCNEV150-MN	High Voltage DC Contactor Relay Bottom Mount with Non-Polar Load Terminals	●		●	●

* Box Packaging Available

DCNEV150 SERIES HIGH CURRENT HIGH VOLTAGE DC CONTACTOR

Dimensions in MM

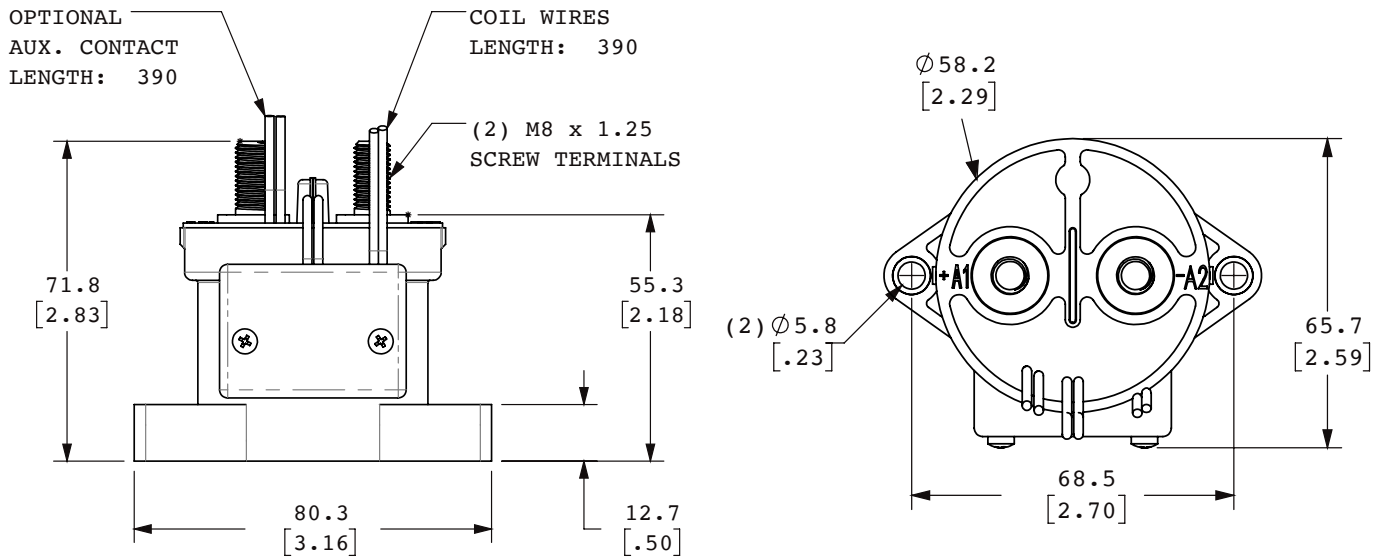

Estimated Make Break Chart

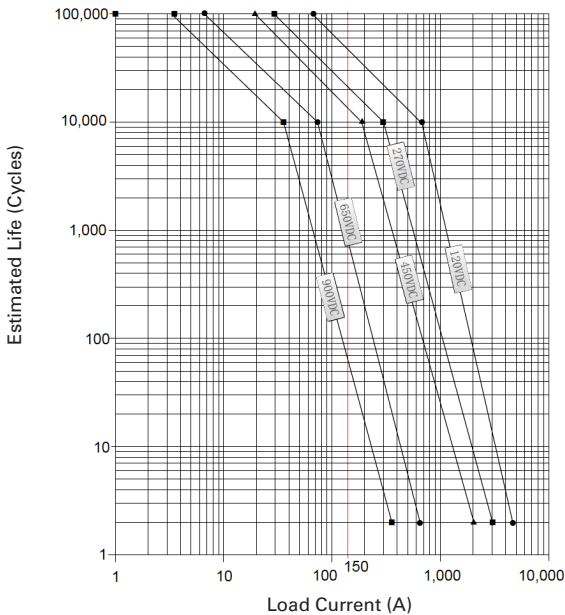

- 1: For resistive loads with 300uH maximum inductance.
- 2: The maximum make current is 650A to avoid contact welding.
- 3: Estimates based on extrapolated data. User to confirm performance in application.

Capacitive Make Test Curve

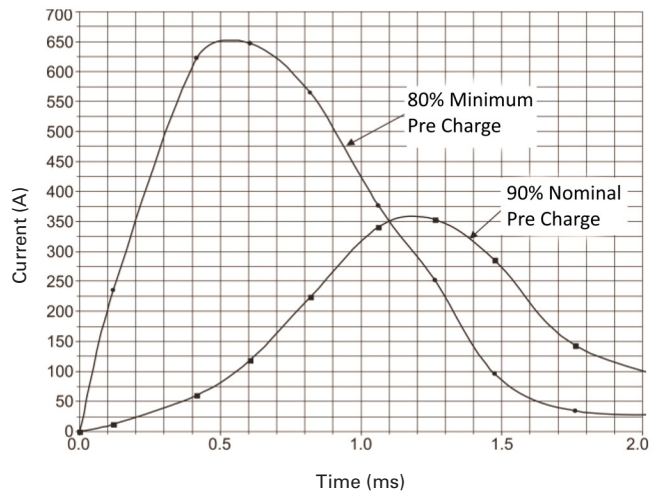

Electrical Load Life Ratings for Typical EV Applications

MAKE/BREAK LIFE CAPACITIVE & RESISTIVE LOADS AT 320VDC¹

@90% pre-charge (make only), see chart below	50,000 cycles
@Min 80% pre-charge (make only), see chart below	50 cycles

1: Resistive load includes L=25uH. Load @2500A, test @200uH

Electrical Diagram

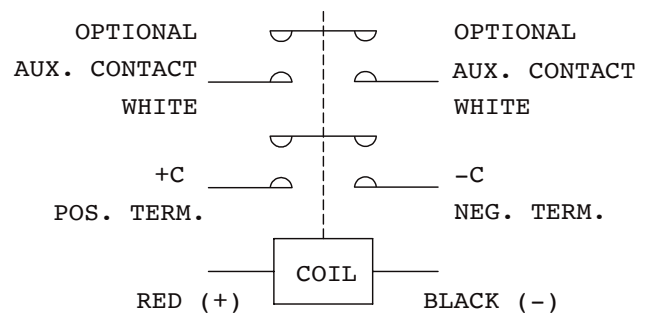

DCNEV150 SERIES HIGH CURRENT HIGH VOLTAGE DC CONTACTOR

Performance Data

MAIN CONTACT	
Contact arrangement	1 Form X (SPST-NO, DM)
Rated Operating Voltage	12-90VDC
Continuous (Carry) Current	150A -200A (65 °C)
Make/Break current	See chart below
Max short circuit current	2,000A @320VDC, 1 cycle *1
Dielectric Withstanding Voltage	Between Contacts: 2,200Vrms, ≤1mA Contact to Coil: 2,200 Vrms, ≤1mA
Insulation Resistance *2	Terminal to Terminal/Terminal to coil New: Min 100 MΩ @500Vdc End of life: Min 50 MΩ @500Vdc
Voltage Drop (@150A)	≤60mV

1: Does not meet dielectric & IR after test.

COIL DATA	
Coil Voltage	9-36Vdc
Voltage (Max.)	36Vdc
Pickup voltage (Max.)	9Vdc
Hold voltage (Min.)	7.5Vdc
Dropout voltage (Min.)	6Vdc
Inrush Current (Max.)	3.8A
Holding Currnet (Avg.)	0.13A@12Vdc / 0.07A@24Vdc

MAX. BREAKING LIMIT	MAX. SHORT CIRCUIT
1,500A @ 450VDC, 1 cycle	2,000A, 1 sec

LIFE	
Resistive load life	See estimated make break chart
Mechanical life	200,000 cycles

OPERATE / RELEASE TIME	
Close (includes bounce)	25ms, Max.
Bounce (after close only)	7ms, Max.
Release (@2000A includes arc)	12ms, Max.

ENVIRONMENTAL DATA	
Shock, 11ms ½ sine, operating	20G Peak
Vibration, Sine, Peak, 20G	80—2,000Hz
Operating Ambient Temperature	-40 to +85°C
Weight	0.95 Lb (0.43 kg)
Altitude	<4000m

AUX. CONTACT	
Aux. Contact Arrangement	1 Form A
Aux. Contact Current Max	2A@30VDC/ 3A@125VAC
Aux. Contact Current Min	100mA@8V
Max. Contact Resistance	0.417Ω@30VDC 0.150Ω@125VAC

Current vs Time Curve

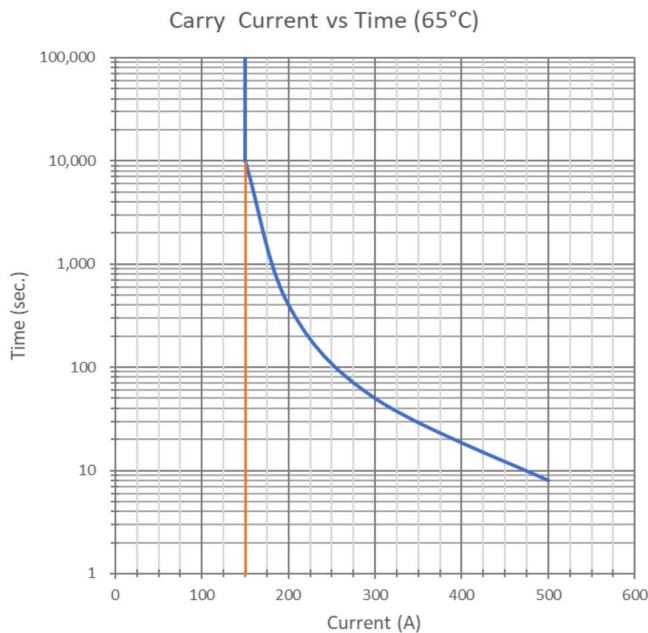

Application Note:

- Be sure to use washer to prevent screws from loosening. Screw tightening torque range is specified as below. Exceeding the maximum torque can lead to product failure.
 - Contact torque (M8): 80 - 100 lb.in (8.8 - 11 N.m)
 - Mounting torque: 15 - 30 lb.in (1.7 - 3.3 N.m)
- Contact Terminals are polarized so refer to drawing during connecting. There is a reverse surge absorption circuit so that it is not necessary to use a surge protective device.
- Do not use if dropped.
- Avoid installing in a strong magnetic field (close to a transformer or magnet), or near a heat source.
- Electrical life

Use per load capability and life cycle limits so as not to cause a failure. (treat the contactor as a product with specified life and replace it when necessary). It is possible to make parts burn around the contactor once operating failure occurs. It is necessary to take layout considerations into account and to make sure power shall be cut off within 1 second.
- Lifetime of internal gas diffusion

The contactor is sealed and filled with gas, lifetime of gas diffusion is determined by temperature in contact chamber (ambient temperature + temperature generated by contact operation). Operate only in an ambient temperature from -40 to +85 °C.
- If inductive load (L/R>1ms) then a surge current protection device should be connected in parallel to the inductive load.
- Drive power must be greater than coil power or it will reduce performance capability.
- Avoid debris or oil contamination on the main terminals to optimize contact and avoid excess heat generation.
- Unit operates after power applied for 0.1s, do not rapidly switch unit..