

# HEV Series

## High Voltage Fuses – Rated 450 V DC



### Description

HEV fuses come in six configurations. Each version of the cylindrical high-voltage fuse protects circuits in EVs and hybrid passenger vehicles.

Ask Littelfuse which configuration best meets your needs.

### Features & Benefits

- Available with blade, bolt down, or PCB connectors
- Available as a cartridge fuse

### Applications

- EVs
- Hybrid passenger vehicles

### Additional Information



Resources



Samples

[See Disclaimer Notice](#)

### Specifications

<b>Voltage Rating (10 A, 15 A, 20 A, 30 A):</b>	450 V DC
<b>Voltage Rating (40 A):</b>	425 V DC
<b>Interrupting Rating (10 A, 15 A, 20 A, 30 A):</b>	10 kA @ 450 V DC
<b>Interrupting Rating (40 A):</b>	10 kA @ 425 V DC
<b>Operating Temperature Range:</b>	-40 °C to +125 °C

**Note:** The OHEV040.ZXBD is rated at 450 V DC.

### Ordering Information

Part Number	Termination	Package Size
OHEVxxx.ZXC	Cartridge	240
OHEVxxx.ZXISO	Bolt Down (ISO)	240
OHEVxxx.ZXPY	Blade	240
OHEVxxx.ZXBD	Bolt Down (Axial)	240
OHEVxxx.ZXPCB	PCB Mount	240
OHEVxxx.ZXPCBL	PCB Mount (Long)	240

# HEV Series

## High Voltage Fuses – Rated 450 V DC

### Ratings

Part Number	Current Rating (A)	Color Coding	Typ. Voltage Drop at 70% I <sub>R</sub> (mV)	Maximum Voltage Drop Spec at 100% IR (mV)	Typ. Cold Resistance (mΩ)	Min. I <sup>2</sup> t (A <sup>2</sup> s)
0HEV010.xxx	10		114	300	12.8	255
0HEV015.xxx	15		96	200	7.9	133
0HEV020.xxx	20		79	200	5.0	268
0HEV030.xxx	30		67	200	2.7	993
0HEV040.xxx	40		69	200	2.0	1495

**Note:** The typical I<sup>2</sup>t is an average value calculated from the breaking capacity tests by using the melting time before the arcing occurs.

### Dimensions

Dimensions in mm. Please refer to the outline drawing for dimensions and tolerances.

ZXC Cartridge

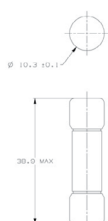

ZXISO Bolt Down (ISO)

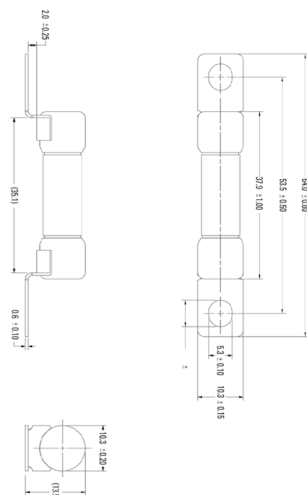

ZXPY Blade

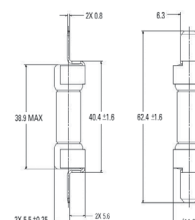

ZXBD Bolt Down (Axial)

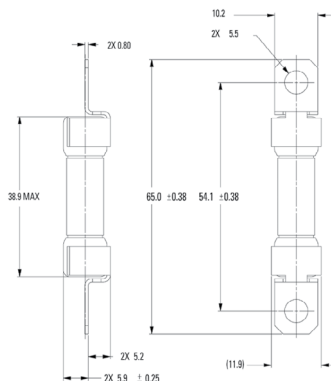

ZXPCB PCB Mount

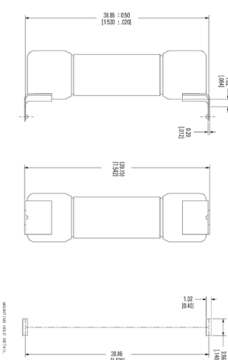

ZXPCBL PCB Mount (Long)

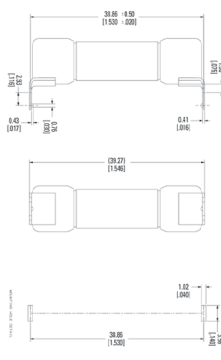

# HEV Series

High Voltage Fuses – Rated 450 V DC

## Time-Current Characteristic

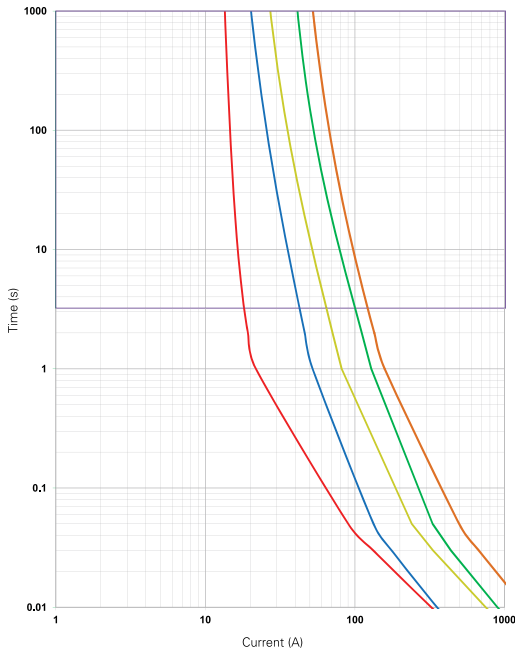

% of Rating	Opening Time Min. / Max. (s)		
	10 A	15 A - 30 A	40 A
100	100 hrs / -	100 hrs / -	100 hrs / -
110	4 hrs / -	4 hrs / -	-
135	100 / 3600	150 / 3600	150 / 3600
150	10 / 1000	10 / 1000	10 / 1000
200	0.5 / 100	0.5 / 100	0.5 / 100
300	0.1 / 15	0.1 / 15	0.1 / 15
500	0.05 / 1	0.05 / 1	0.05 / 1

- 10 A
- 15 A
- 20 A
- 30 A
- 40 A

**Note:** Current recommendation may be impacted by the final condition of the application (terminals characteristics, wire size etc.). Please contact Littelfuse® for more information.

## Typical Derating Curves

Temperature security margin is 20%.

Please contact Littelfuse® for Details Regarding Derating Test Set Up.

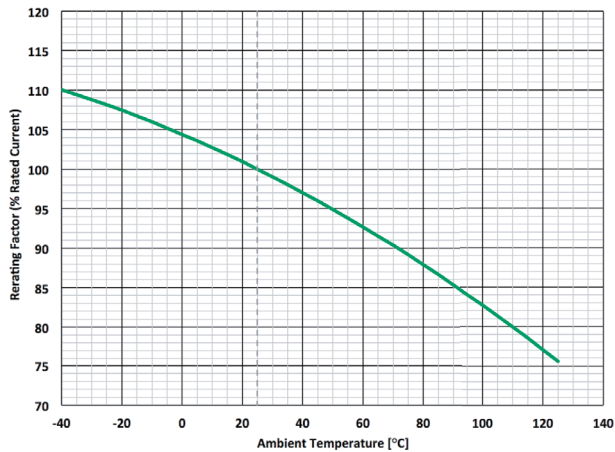

**Note:** Current recommendation may be impacted by the final condition of the application (terminals characteristics, wire size etc.). Please contact Littelfuse® for more information.

**Disclaimer Notice** - Information furnished is believed to be accurate and reliable. However, users should independently evaluate the suitability of and test each product selected for their own applications. Littelfuse products are not designed for, and may not be used in, all applications. Read complete Disclaimer Notice at <https://www.littelfuse.com/legal/disclaimers/product-disclaimer.aspx>