

MEGA® High Performance Fuses

Rated 70 V-SF56



Description

MEGA® 70V High Performance SF56 automotive fuses employ diffusion pill technology to provide predictable time-delayed circuit protection. These MEGA fuses are ideal for protecting batteries, alternators, and heavy gauge wire harnesses that experience large inrushes of current. Use fuses with ampere ratings between 350 A and 500 A only for short circuit protection.

Features & Benefits

- 1 Mohm open state resistance at 100 V
- High-contrast color coding on housing aids identification
- High tightening torque resistance
- Available with two, one, or no mounting holes
- Comply with ISO 20934 – Type SF56
- 56 mm pitch prevents mistaken replacement with other types of high-current fuses

Additional Information



Resources

Applications

- Cars / SUVs
- Trucks
- Power Tools
- 2/3 wheelers
- Offroad vehicles
- Buses
- Watercraft as approved by Littelfuse®

[See Disclaimer Notice](#)

Specifications

Voltage Rating:	70 V DC
Interrupting Rating:	2500 A @ 70 V DC
Recommended Environmental Temperature:	-40 °C to +125 °C
Terminals Material:	Tin-plated copper alloy
Housing Material:	PPA-GF33 (UL 94 Flammability rating of HB)
Open State Resistance (OSR):	> 1 Mohm (after fuse opening) at 100 V
Typical Weight per Fuse:	12.0 g
Mounting Torque M6:	9 Nm ± 1 Nm
Mounting Torque M8:	20 Nm ± 1 Nm
Comply With:	ISO 20934 - Type SF56















MEGA[®] High Performance Fuses

Rated 70 V-SF56

Ordering Information

Part Number	Current Rating (A)	Package Size	Bolt Size	Bolt Hole Qty
0898xxx.U-2M8	60 – 500	500	M8	2
0898xxx.U-1M8	60 – 500	500	M8	1
0898xxx.U-2M6	60 – 500	500	M6	2
0898xxx.U-1M6	60 – 500	500	M6	1
0898xxx.U-NH	60 – 500	500	-	0

Ratings

Part Number	Current Rating (A)	Font Color	Test Cable Size (mm ²)	Typ. Voltage Drop (mV)	Typ. Cold Resistance (mΩ)	Typ. I ² t (A ² s)
0898060._	60		6	75.5	0.90	22 800
0898080._	80		10	88.0	0.75	34 900
0898100._	100		10	66.7	0.46	24 000
0898125._	125		16	70.4	0.37	38 000
0898150._	150		25	70.6	0.32	58 100
0898175._	175		25	79.2	0.28	79 300
0898200._	200		35	76.9	0.24	123 600
0898225._	225		35	76.6	0.21	142 500
0898250._	250		50	66.0	0.17	220 000
0898300._	300		50	46.9 ²	0.15	340 000
0898350._	350 ¹		50	50.7 ²	0.14	495 000
0898400._	400 ¹		70	50.1 ²	0.12	872 000
0898450._	450 ¹		70	52.9 ²	0.10	1 224 000
0898500._	500 ¹		70	56.3 ²	0.09	1 800 000

Note: The typical I²t is an average value calculated from the breaking capacity tests by using the melting time before the arcing occurs.

1: Short Circuit protectors

2: Voltage drop measurement taken at 75% of rated current

MEGA[®] High Performance Fuses

Rated 70 V-SF56

Dimensions

Dimensions in mm. Please refer to the outline drawing for dimensions and tolerances.

2-Holes version (M8/ M6)

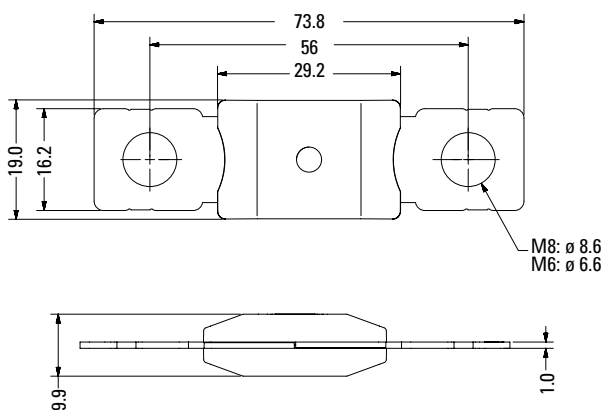

1-Hole version (M8/M6)

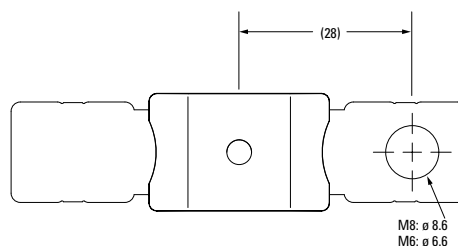

No-Holes version

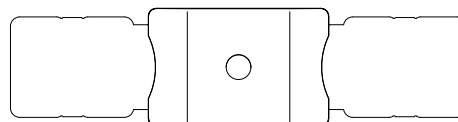

MEGA[®] High Performance Fuses

Rated 70 V-SF56

Time-Current Characteristic

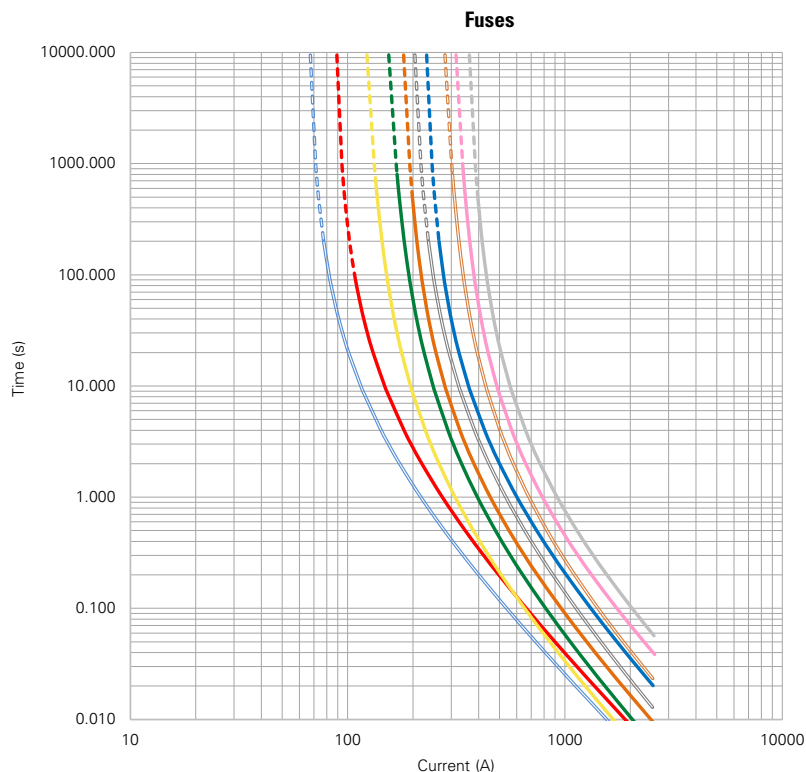

% of Rating	Opening Time Min / Max (s)	
	60-250	300
75	- / -	14 400 / ∞
100	14 400 / ∞	- / -
135	120 / 1800	120 / 1800
150	20 / 450	20 / 450
200	1 / 15	1 / 15
350	0.3 / 5	0.3 / 5
600	0.1 / 1	0.1 / 1

- 60 A — 175 A
- 80 A — 200 A
- 100 A — 225 A
- 125 A — 250 A
- 150 A — 300 A

Note: Current recommendation may be impacted by the final condition of the application (terminals characteristics, wire size etc.). Please contact Littelfuse[®] for more information.

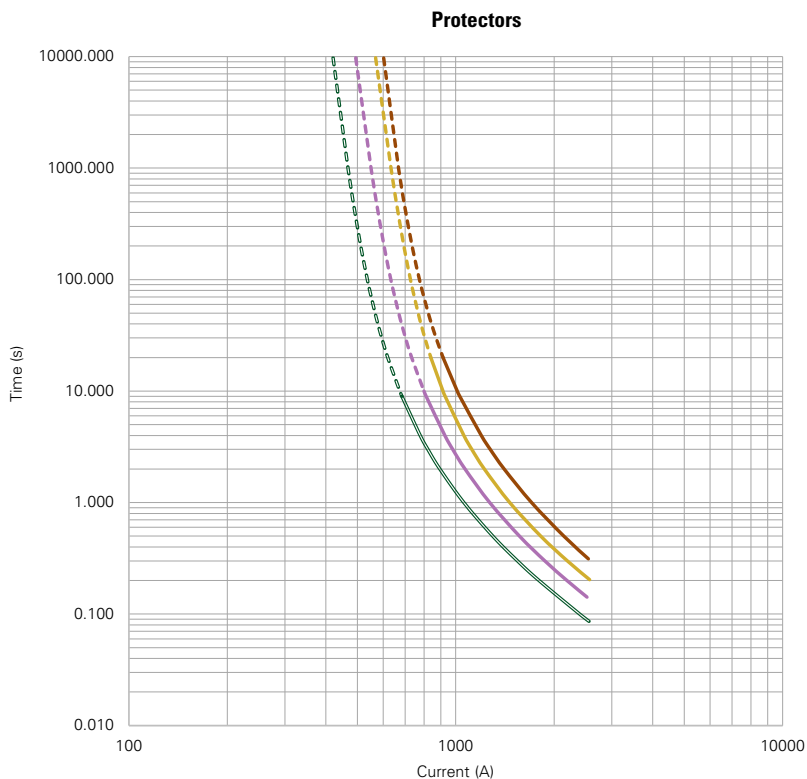

% of Rating	Opening Time Min / Max (s)
	350-500
75	14 400 / ∞
100	- / -
135	- / -
150	- / -
200	1 / 15
350	0.5 / 5
600	0.1 / 1

- 350 A
- 400 A
- 450 A
- 500 A

Note: Current recommendation may be impacted by the final condition of the application (terminals characteristics, wire size etc.). Please contact Littelfuse[®] for more information.

MEGA® High Performance Fuses

Rated 70 V-SF56

Typical Derating Curves

Please contact Littelfuse® for Details Regarding Derating Test Set Up

Fuses

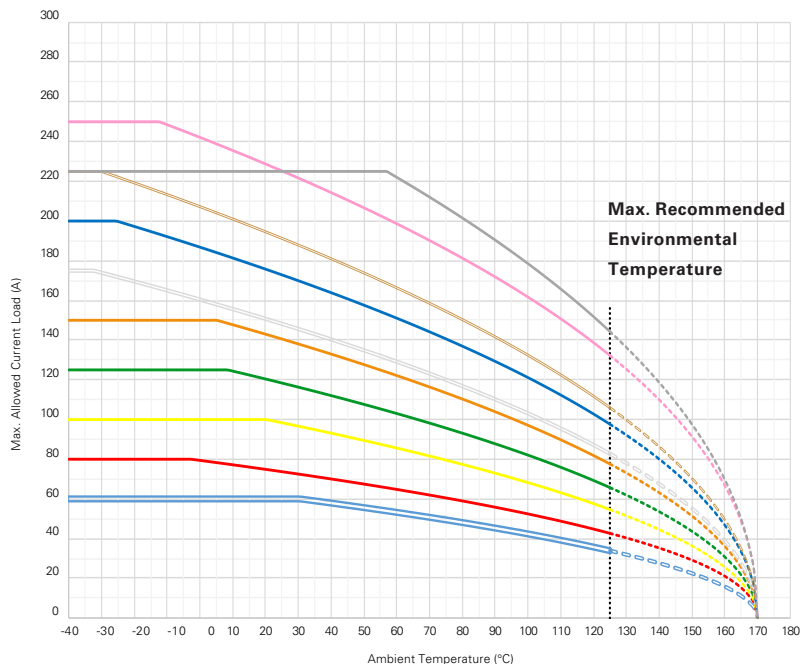

Max. allowed current load (A) at ambient temperature based on typical derating

	-40 °C	0 °C	20 °C	65 °C	85 °C	110 °C	125 °C
60A	60	60	60	52	47	39	34
80A	80	79	75	63	57	49	43
100A	100	100	100	84	75	63	55
125A	125	125	120	101	90	76	66
150A	150	150	143	119	107	90	78
175A	175	160	151	126	114	95	83
200A	200	187	176	148	133	112	98
225A	225	207	195	163	146	123	106
250A	250	242	229	194	177	151	132
300A	225	225	225	217	196	166	144

- 60 A
- 80 A
- 100 A
- 125 A
- 150 A
- 175 A
- 200 A
- 225 A
- 250 A
- 300 A

Note: Current recommendation may be impacted by the final condition of the application (terminals characteristics, wire size etc.). Please contact Littelfuse® for more information.

Protectors

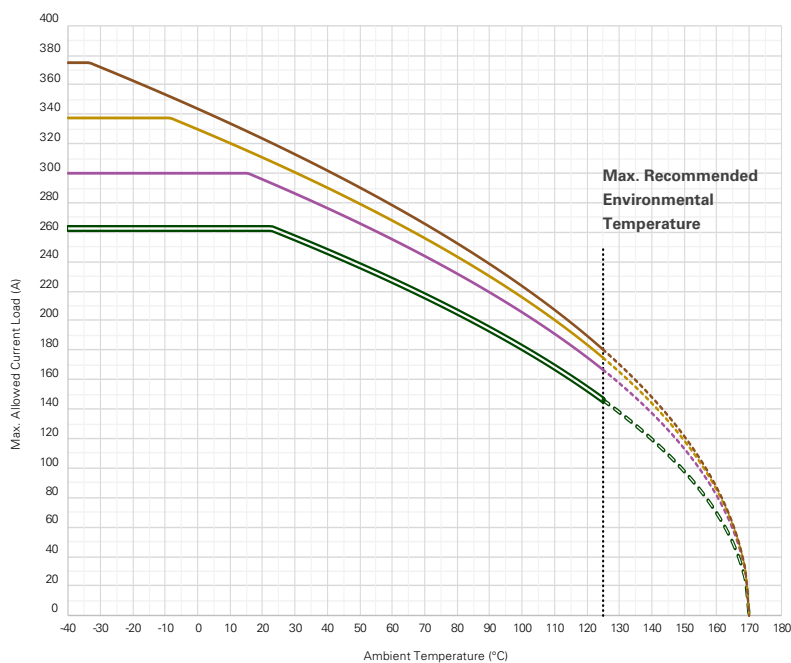

Max. allowed current load (A) at ambient temperature based on typical derating

	-40 °C	0 °C	20 °C	65 °C	85 °C	110 °C	125 °C
350A	263	263	263	222	200	168	146
400A	300	300	296	250	226	191	167
450A	338	330	311	262	237	201	175
500A	375	344	323	272	246	207	180

- 350 A
- 400 A
- 450 A
- 500 A

Note: Current recommendation may be impacted by the final condition of the application (terminals characteristics, wire size etc.). Please contact Littelfuse® for more information.

Disclaimer Notice - Information furnished is believed to be accurate and reliable. However, users should independently evaluate the suitability of and test each product selected for their own applications. Littelfuse products are not designed for, and may not be used in, all applications. Read complete Disclaimer Notice at <https://www.littelfuse.com/legal/disclaimers/product-disclaimer.aspx>