

MIDI High Performance Series

Bolt-down Fuses – Rated 70V-SF36

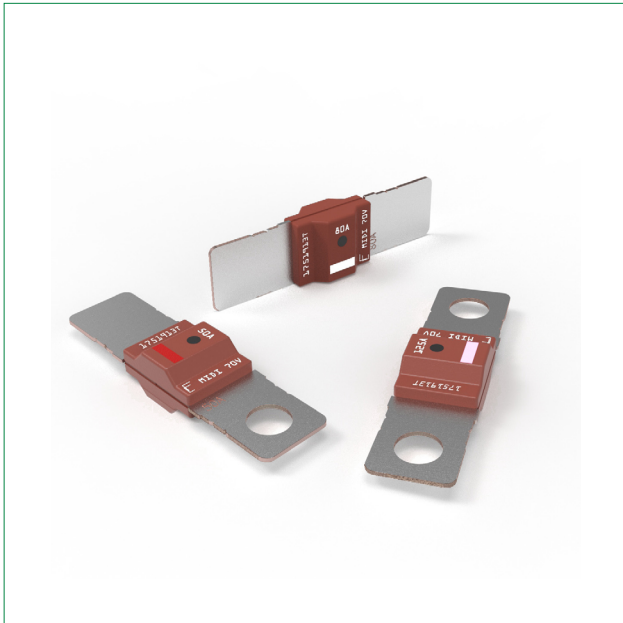

Description

MIDI® High Performance 70V automotive fuses protect circuits that receive large inrushes of current, such as those for fans, heaters, batteries, and starters. Silicon inserts ensure these fuses offer more than 1 Mohm of resistance in their open state. Like all bolt-down MIDI fuses, these employ diffusion pill technology to offer predictable time-delayed performance.

Features & Benefits

- 1 Mohm open state resistance
- High-contrast color coding on housing aids identification
- High tightening torque resistance
- Available with two, one, or no mounting holes
- Recognized as UL 248-1 Special Purpose Fuses (at 70V DC File E71611) and Directive 2011/65/EU
- Refers to ISO 20934 – Type SF36

Applications

- Cars / SUVs
- Trucks
- Offroad vehicles
- Power Tools
- 2/3 wheelers
- Buses
- Watercraft as approved by Littelfuse®

Agency Approvals

Agency	Agency File Number	Current Rating (A)
	ULUS-L71611-295-03219102-3	30 A - 200 A

Additional Information



Resources



Samples

[See Disclaimer Notice](#)

Specifications

Voltage Rating:	70 V DC
Interrupting Rating:	2500 A @ 70 V DC
Recommended Environmental Temperature:	-40 °C to +125 °C
Terminals Material:	Tin-plated copper alloy
Housing Material:	PA66-GF25 FR (UL 94 Flammability rating of V-0)
Open State Resistance (OSR):	> 1 Mohm (after fuse opening)
Mounting Torque M6:	9 Nm +/- 1Nm
Typical Weight per Fuse:	3.5 g
Refers To:	ISO 20934 – Type SF36. Fuse ratings 150 A, 175 A and 200 A deviate from ISO standard (current cycles and current steps not applicable).
Comply With:	Standard UL 248-1 as a Special Purpose Fuse in UL File E71611 and Directive 2011/65/EU.











MIDI High Performance Series

Bolt-down Fuses – Rated 70V-SF36

Ordering Information

Part Number	Current Rating (A)	Bolt Size	Bolt Qty.	Package Size
4998xxx.M-M6	30 – 200	M6	2	500
4998xxx.M1M6	30 – 200	M6	1	500
4998xxx.M-NH	30 – 200	-	0	500

Ratings

Part Number	Current Rating (A)	Housing Material Color	Test Cable Size (mm ²)	Typ. Voltage Drop (mV)	Typ. Cold Resistance (mΩ)	Typ. I ² t (A ² s)
4998030.M_	30		2.5	100	2.20	3200
4998040.M_	40		4	94	1.56	4700
4998050.M_	50		6	86	1.16	7500
4998060.M_	60		6	81	0.94	6800
4998070.M_	70		10	76	0.74	10 900
4998080.M_	80		10	64	0.57	10 500
4998100.M_	100		10	68	0.44	18 300
4998125.M_	125		16	66	0.35	51 300
4998150.M_	150		25	72	0.29	45 100
4998175.M_	175		25	70	0.24	88 000
4998200.M_	200		35	67	0.20	111 700

Note: The typical I²t is an average value calculated from the breaking capacity tests by using the melting time before the arcing occurs.

Dimensions

Dimensions in mm. Please refer to the outline drawing for dimensions and tolerances.

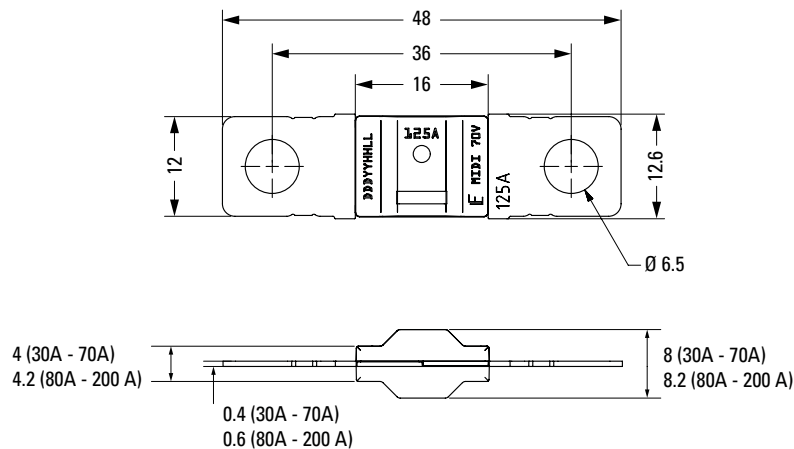

MIDI High Performance Series

Bolt-down Fuses – Rated 70V-SF36

Time-Current Characteristic

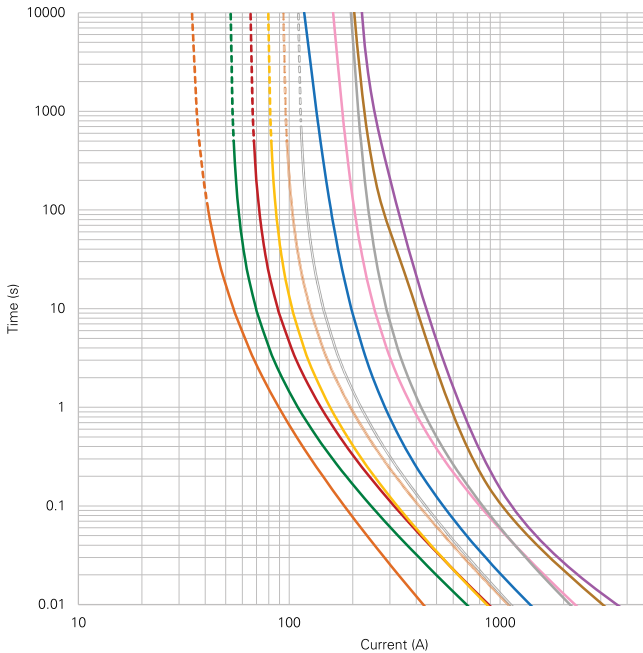

% of Rating	Opening Time Min. / Max. (s)
100	360 000 / -
135	300 / 3 600
150	90 / 500
200	1 / 50
300	0.3 / 4
500	0.1 / 1
600	0.07 / 0.7

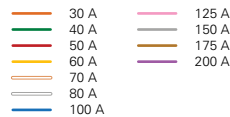

Note 1: Current recommendation may be impacted by the final condition of the application (terminals characteristics, wire size etc.). Please contact Littelfuse® for more information.

Note 2: Fuse ratings 150 A, 175 A and 200 A deviate from ISO standard (current cycles and current steps not applicable).

Typical Derating Curves

Temperature security margin is 20%

Please contact Littelfuse® for Details Regarding Derating Test Set Up.

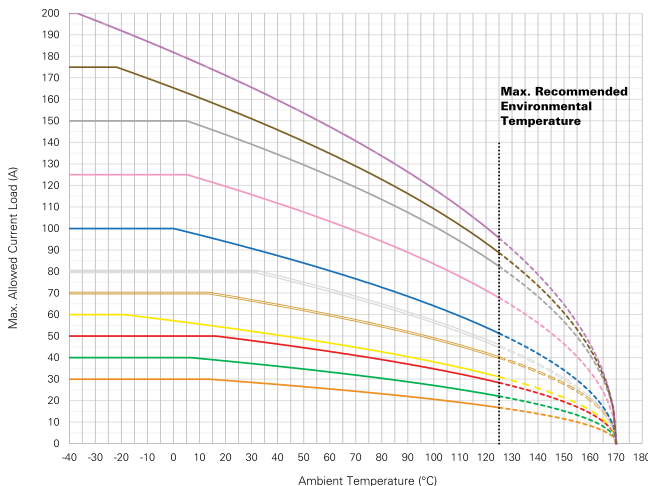

	Max. allowed current load (A) at ambient temperature based on typical derating						
	-40 °C	0 °C	20 °C	65 °C	85 °C	110 °C	125 °C
30 A	30	30	29	25	23	19	17
40 A	40	40	38	33	30	25	22
50 A	50	50	49	42	38	32	28
60 A	57	57	54	46	42	35	31
70 A	70	70	69	59	53	46	40
80 A	80	80	80	70	63	52	45
100 A	100	100	94	78	71	59	51
125 A	125	125	120	101	91	78	68
150 A	150	150	144	122	110	94	82
175 A	175	165	156	132	119	101	89
200 A	200	182	171	144	130	110	96

Note: Current recommendation may be impacted by the final condition of the application (terminals characteristics, wire size etc.). Please contact Littelfuse® for more information.

Disclaimer Notice - Information furnished is believed to be accurate and reliable. However, users should independently evaluate the suitability of and test each product selected for their own applications. Littelfuse products are not designed for, and may not be used in, all applications. Read complete Disclaimer Notice at <https://www.littelfuse.com/legal/disclaimers/product-disclaimer.aspx>