

BF2

Bolt-down Fuse Rated 32V



Specifications

Voltage Rating:	32 VDC	
Interrupting Rating:	100 A - 300 A:	2000A @ 32 VDC
	400 A - 500 A:	1500A @ 32 VDC
Recommended Environmental Temperature:	-40°C to +125°C	
Terminals Material:	Tin plated Copper	
Opaque Housing Material:	PET-GF33 (U.L. 94 Flammability rating – V0)	
Clear Housing Material:	PES (U.L. 94 Flammability rating –V0)	
Mounting Torque M8:	12 Nm +/- 1Nm	
Complies with:	UL 248 Special Purpose Fuse	
Refers To:	ISO 8820-5:2015	

Description

BF2 32V fuses use Slo-Blo® technology to protect high-current wiring harnesses. Use the 300 A, 400 A, and 500 A fuses only for short circuit protection.

Applications

- Cars
- Trucks
- SUVs
- Offroad vehicles
- Buses
- Watercraft as approved by Littelfuse®

Features & Benefits

- Color coding indicates ampere rating
- High-contrast ampere rating stamps aid identification
- Transparent cover make it easier to see when fuse blow











Ordering Information

Part Number	Rating	Package Size
Standard M8 Holes		
153.5395.xxxx	100 - 500	200

BF2

Bolt-down Fuse Rated 32V

Ratings

Part Number	Current Rating (A)	Housing Color	Test Cable Size (mm ²)	Typ. Voltage Drop (mV)	Typ. Cold Resistance (mΩ)	Typ. I ² t (A ² s)
153.5395.6102	100		16	102	0.70	46 800
153.5395.6122	125		25	81	0.52	118 100
153.5395.6152	150		25	77	0.42	113 400
153.5395.6172	175		25	104	0.36	154 400
153.5395.6202	200		35	102	0.34	288 000
153.5395.6222	225		35	107	0.29	236 000
153.5395.6252	250		50	86	0.25	292 500
153.5395.6302 ¹	300		70	68	0.21	486 000
153.5395.6402 ¹	400		70	70	0.13	964 000
153.5395.6502 ¹	500		70	60	0.12	1 449 000

Note 1: Short Circuit Protector only

The typical I²t is an average value calculated from the breaking capacity tests by using the melting time before the arcing occurs.

Dimensions

Dimensions in mm for reference only.

See outline drawing for dimensions and tolerances.

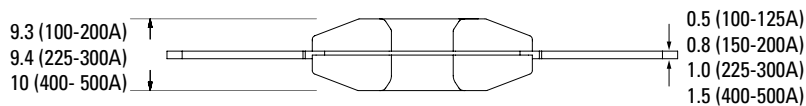
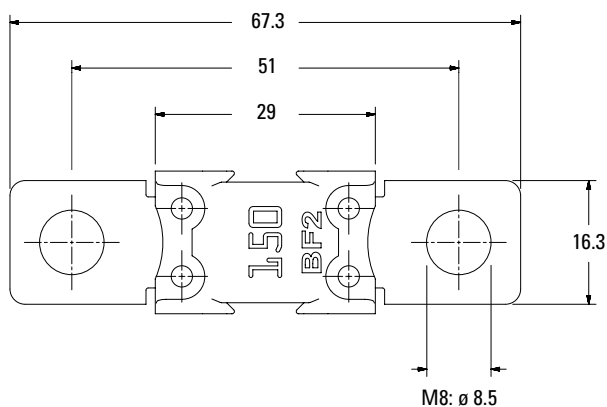

BF2

Bolt-down Fuse Rated 32V

Time-Current Characteristic Curves

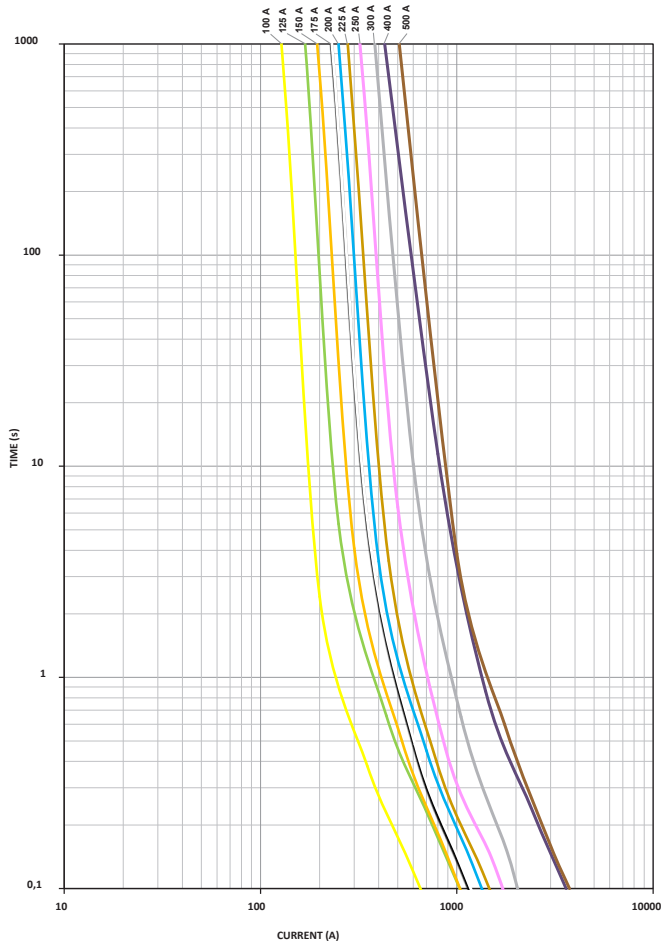

Time-Current Characteristics

% of Rating	Opening Time Min / Max (s)	
	100 A - 250 A	300 A - 500 A
75	- / -	14 400 / ∞
100	14,400 / ∞	- / -
135	120 / 1 800	- / -
200	1 / 15	1 / 15
350	0.3 / 5	0.5 / 5
600	0.1 / 1	0.1 / 1

BF2

Bolt-down Fuse Rated 32V

Typical Derating of Fuse Melting Element

Temperature Security Margin is 20%

Please Contact Littelfuse® For Details Regarding Derating Test Set Up

Temperature Table

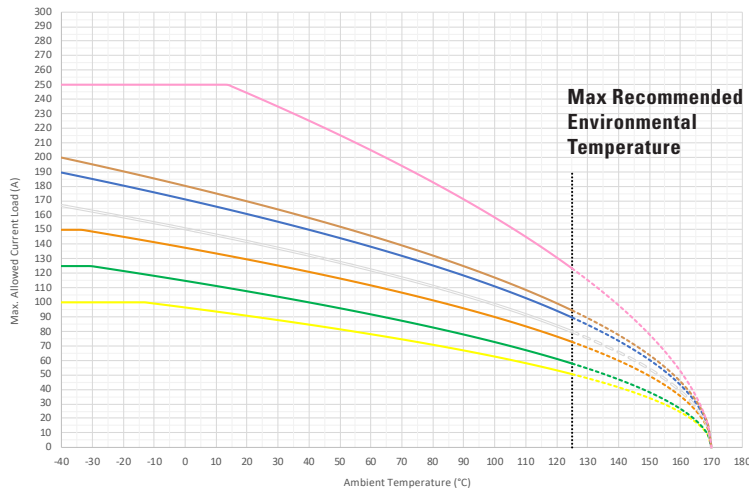

max. allowed current load (A) at ambient temperature (typical derating)

	-40°C	0°C	20°C	65°C	85°C	110°C	125°C
100 A	100	96	91	76	69	58	50
125 A	125	115	108	90	80	67	58
150 A	150	138	130	109	99	83	73
175 A	167	151	142	120	108	92	80
200 A	189	171	161	135	122	103	90
225 A	200	180	170	143	129	109	94
250 A	250	250	244	200	177	145	123
300 A	225	225	225	201	181	153	133
400 A	300	300	300	262	236	198	172
500 A	364	329	311	263	238	202	177

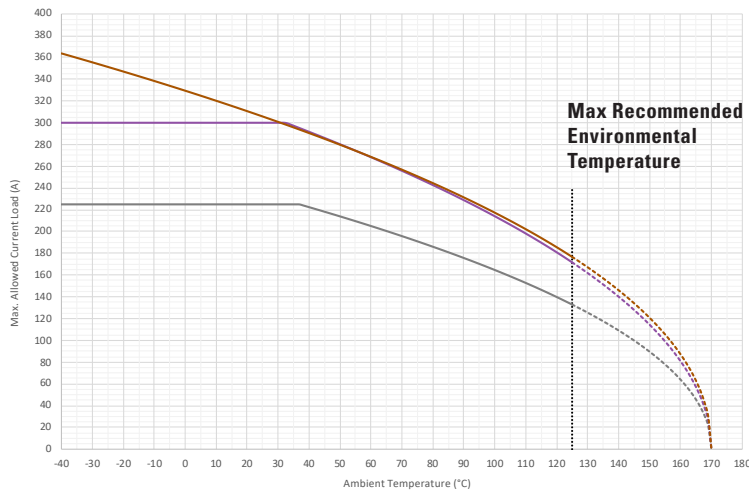

Derating curves may change depending on the final condition of the application (terminals characteristics, wire size etc.). Please ask Littelfuse® for more information.