

ITV2718 5A Series

Surface Mount

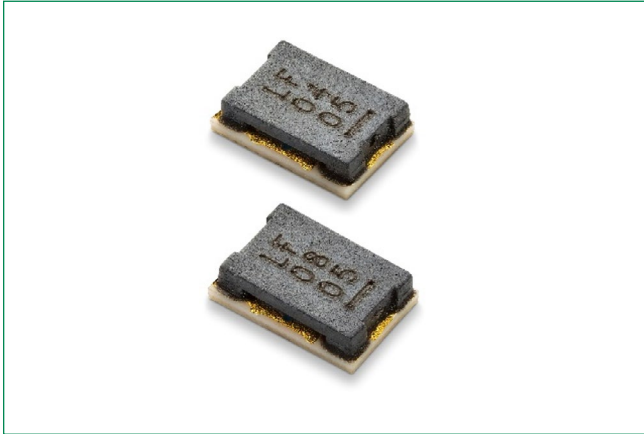

Description

ITV is a three-terminal surface-mountable lithium battery protector designed to guard against damage caused by overcurrent and overcharging. A fuse element is embedded to cut off the circuit when an overcurrent issue occurs. A heater is also directly embedded under the fuse element. It will generate heat to blow the fuse once overvoltage is detected by IC or FET.

Features & Benefits

- Halogen-free
- Overcharging protection
- Overcurrent protection
- Surface mountable
- Fast response time

Applications

- Notebook
- Cell phone
- Camera
- Ultrabook
- Tablet PC
- Automotive applications
- Printer
- Security systems

Agency Approvals

Agency	Agency File Number	Ampere Range
	E10480	5 A
	TA 50461285	5 A

Thermal Derating Characteristics

Ambient Operating Temperature			
	25 °C	40 °C	60 °C
Recommended Rated Current	6.0	5.0	4.5

Electrical Characteristics

Part Number	Ordering Code	I _{rated} (A)	Cell in Series	V _{max} (Vdc)	I _{break} (A)	V _{OP} (V)	Resistance		Agency Approvals	
							R _{heater} (Ω)	R _{fuse} (mΩ)		
ITV2718L0405	ITV2718L0405YR	5	1	36	50	2.5 ~ 5.5	0.90~2.05	≤10.0	X	X
ITV2718L0805	ITV2718L0805YR	5	2	36	50	4.0 ~ 10.0	2.70~5.35	≤10.0	X	X
Current Capacity		100% x I _{rated} , No Melting								
Cut Time		200% x I _{rated} , < 1 min								
Over Voltage Operation		In operation voltage range, the fusing time is <1min								

Notes:

I_{rated} = Current carrying capacity that is measured at 40°C thermal equilibrium condition
 I_{break} = The current that the fuse element is able to interrupt
 V_{max} = The maximum voltage that can be cut off by fuse
 V_{OP} = Range of operation voltage
 R_{heater} = The resistance of the heating element
 R_{fuse} = The resistance of the fuse element
 Cells in series = Number of battery cells connected in series in the circuit for ITV device to protect.

- Value specified is determined by using the PWB with 2mm*0.5oz copper traces, AWG22 covered wire, and 0.6mm glass epoxy PCB.
- Specifications are subject to change without notice.

ITV2718 5A Series

Surface Mount

Cut Time by Heater Operation

Various heater wattage at 25 °C ambient temperature

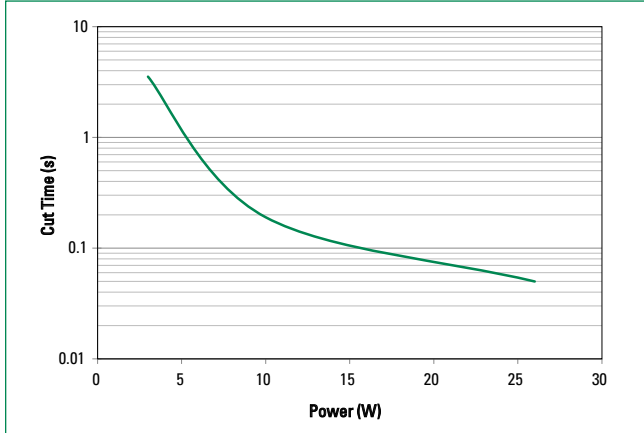

Constant heater wattage at various ambient temperature

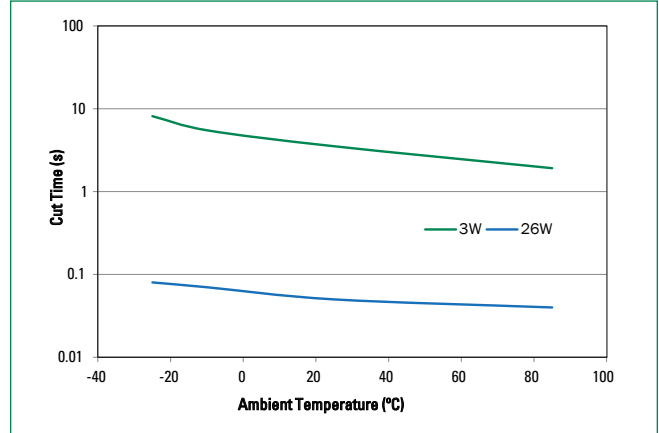

Cut Time by Current Operation

Various interrupting current at 25 °C ambient temperature

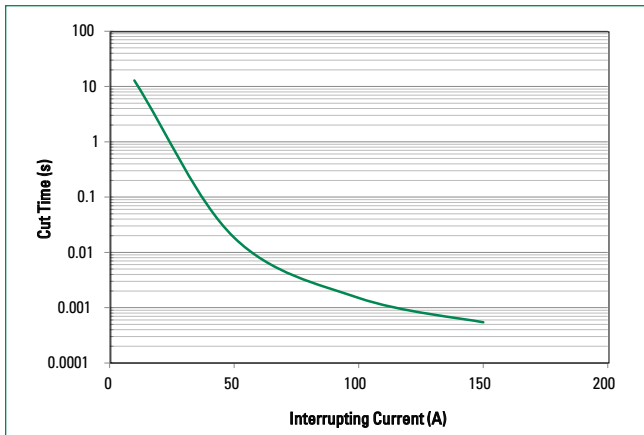

Constant 2x rated current at various ambient temperature

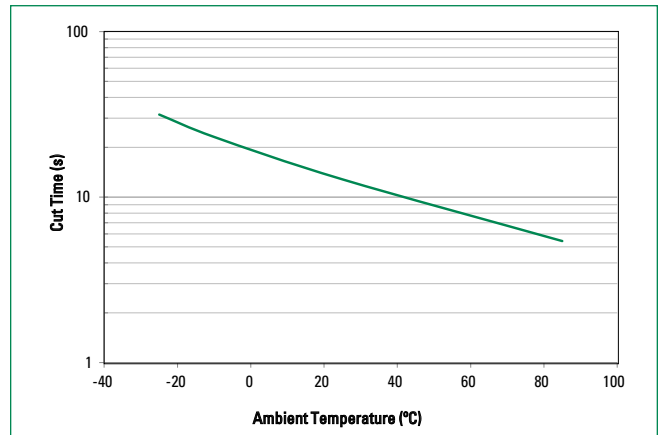

Environmental Specifications

Storage Temperature	0~35 °C, ≤70%RH
Operating Temperature	-10 °C to +65 °C
Hot Passive Aging	100±5 °C, 250 hours No structural damage and functional failure
Humidity Aging	60 °C±2 °C, 90~95% R.H. 250 hours No structural damage and functional failure
Cold Passive Aging	-20±3 °C, 500 hours No structural damage and functional failure

Device Circuit

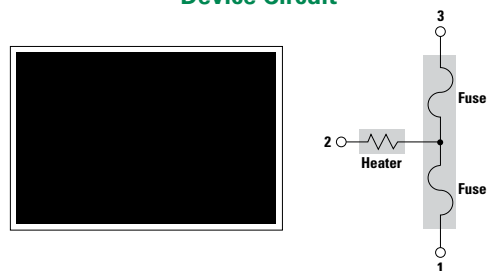

ITV2718 5A Series

Surface Mount

Physical Dimension (mm)

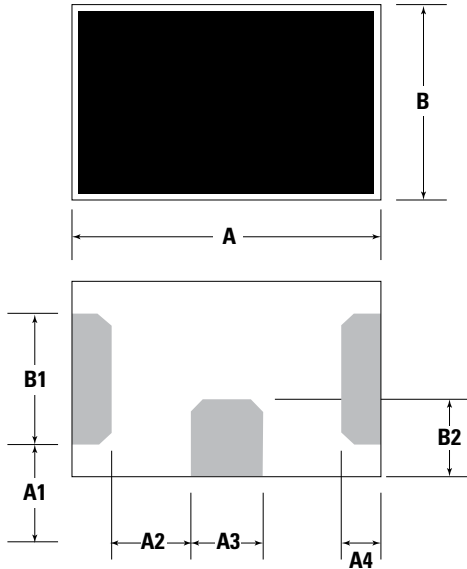

Symbol	Dimension
A	2.70 ± 0.2
B	1.80 ± 0.3
C	0.85 max
A1	0.34 ± 0.1
A2	0.70 ± 0.1
A3	0.62 ± 0.1
A4	0.34 ± 0.1
B1	1.20 ± 0.1
B2	0.70 ± 0.1

Board and Solder Layout Recommend (mm)

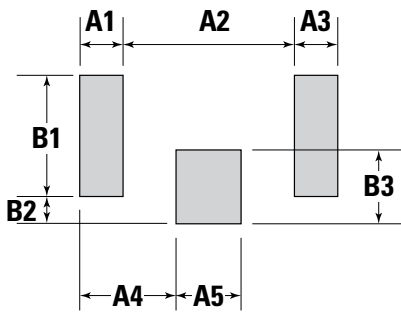

Symbol	Dimension
A1	0.44 ± 0.1
A2	1.92 ± 0.1
A3	0.44 ± 0.1
A4	1.04 ± 0.1
A5	0.72 ± 0.1
B1	1.30 ± 0.1
B2	0.30 ± 0.1
B3	0.80 ± 0.1

Soldering Parameters

Average Ramp-Up Rate ($T_{s_{max}}$ to TP)	3 °C/second max.	
Preheat	Temperature Min ($T_{s_{min}}$)	150 °C
	Temperature Max ($T_{s_{max}}$)	200 °C
	Time ($T_{s_{min}}$ to $T_{s_{max}}$)	60–120 seconds
Time maintained above:	Temperature (T_L)	217 °C
	Time (t_L)	60–105 seconds
Peak Temperature (T_p)	255 °C	
Time within 5°C of actual Peak Temperature (t_p)	5 seconds max.	
Ramp-Down Rate	6 °C/second max.	
Time 25°C to Peak Temperature	8 minutes max.	

Physical Specifications

Material	Glass Epoxy PCB
Base Thickness	0.6 mm
Copper Thickness	0.018 mm
Covered Wire	AWG22

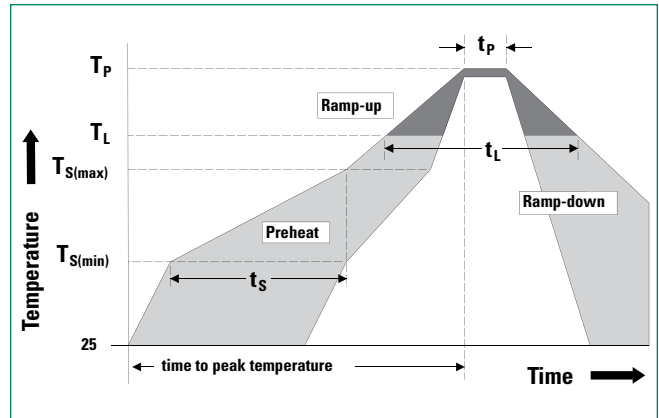

- All temperature refer to topside of the package, measured on the package body surface
 - If reflow temperature exceeds the recommended profile, devices may not meet the performance requirements

ITV2718 5A Series

Surface Mount

Typical Application Circuit Diagram

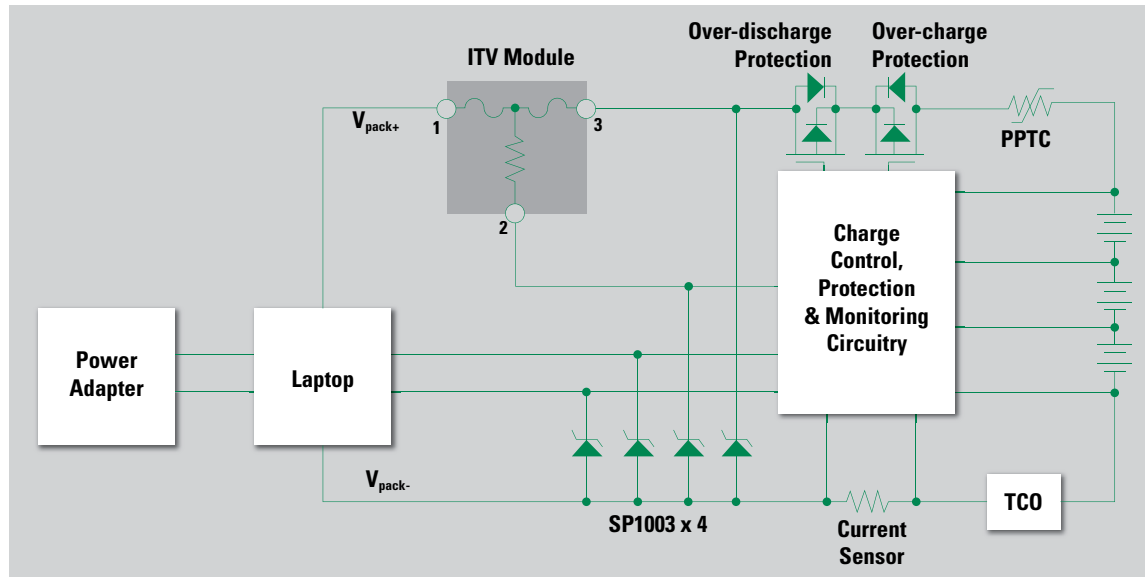

Installation and Handling Guidelines

- Before and after mounted, the ultrasonic-cleaning or immersion-cleaning must not be done to ITV device. The flux on element would flow, and it would not be satisfied its specification when cleaning is done. In addition, a similar influence happens when the product comes in contact with cleaning solution. These products after cleaning will not be guaranteed.
- Silicone-based oils, oils, solvents, gels, electrolytes, fuels, acids, and similar will adversely affect the properties of ITV devices, and shall not be used or applied.
- Please DO NOT reuse the ITV device removed by the soldering process.
- ITV devices are secondary protection devices and are used solely for sporadic, accidental overcurrent or overtemperature error condition, and shall NOT be used if or when constant or repeated fault conditions (such fault conditions may be caused by, among others, incorrect pin-connection of a connector) or over-extensive trip events may occur.
- Operation over the maximum rating or other forms of improper use may cause failure, arcing, flame and/or other damage to the ITV devices.
- The performance of ITV devices will be adversely affected if they are improperly used under electronic, thermal and/or mechanical procedures and/or conditions non-conformant to those recommended by manufacturer.
- Customers shall be responsible for determining whether it is necessary to have back-up, failsafe and/or fool-proof protection to avoid or minimize damage that may result from extra-ordinary, irregular function or failure of ITV devices.
- There should be minimum of 0.1mm spacing between ITV and surrounding compounds, to maintain the product characteristics and avoid damage other surrounding compounds.
- This product is designed and manufactured only for general-use of electronics devices. We do not recommend that it is used for the applications military, medical and so on which may cause direct damages on life, bodies or properties.

ITV2718 5A Series

Surface Mount

Tape and Reel Specifications (mm)

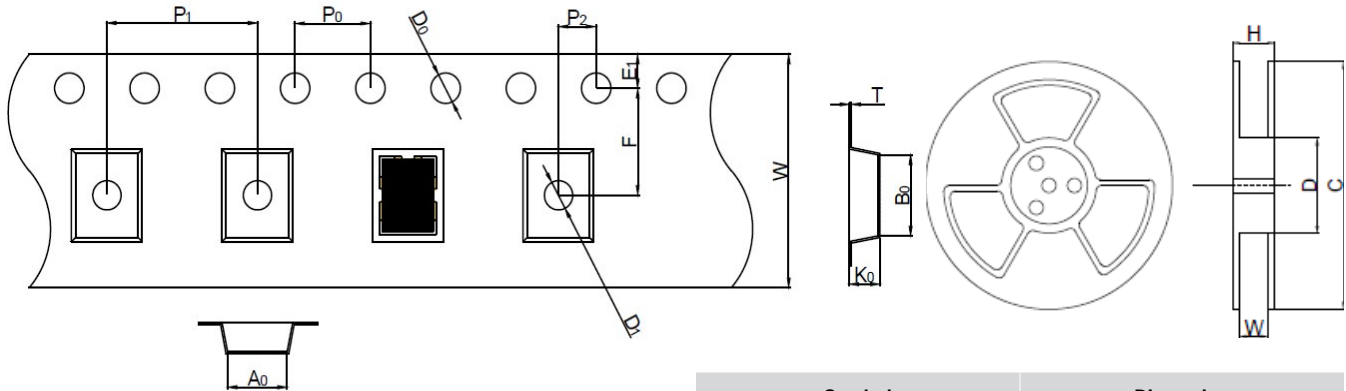

Symbol	Dimension
W	8.0 ± 0.30
F	3.50 ± 0.05
E1	1.75 ± 0.10
D0	1.50 ± 0.10
D1	1.00 ± 0.10
P0	4.00 ± 0.10
P1	4.00 ± 0.10
P2	2.00 ± 0.30
A0	2.08 ± 0.10
B0	2.98 ± 0.10
T	0.25 ± 0.10
K0	1.05 ± 0.10
H	11 ± 1.0
W	9.0 ± 1.0
D	Ø60 ± 0.5
C	Ø178 ± 1.0

Part Numbering System

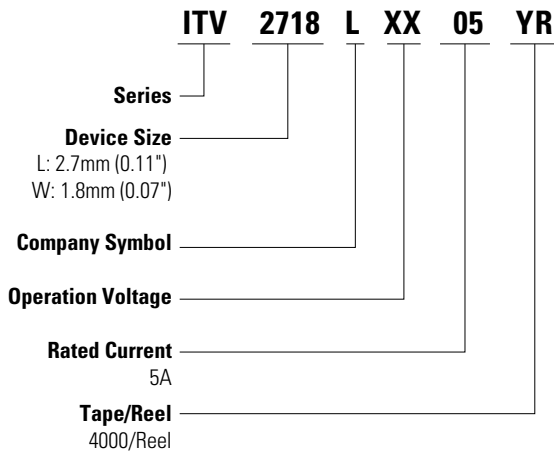

Packaging

Part Number	Tape and Reel Quantity
ITV2718LXX05	4,000

Part Marking System

Marking System for ITV2718 5A Series

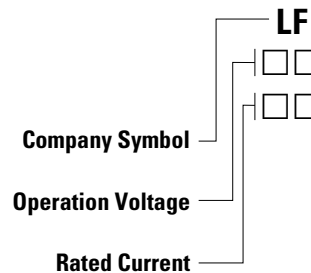

Disclaimer Notice - Information furnished is believed to be accurate and reliable. However, users should independently evaluate the suitability of and test each product selected for their own applications. Littelfuse products are not designed for, and may not be used in, all applications. Read complete Disclaimer Notice at www.littelfuse.com/disclaimer-electronics.