



Parameter	Rating	Units
Blocking Voltage	30	V_P
Load Current	1.5	A_{rms} / A_{DC}
On-Resistance (max)	0.3	Ω
LED Current to Operate	2	mA

Features

- 1.5A Load Current
- 0.3 Ω Max On-Resistance
- 2mA Control Current
- 3750V_{rms} Input/Output Isolation
- Low Drive Power Requirements
- Greater Reliability than Electromechanical Relays
- No EMI/RFI Generation
- Flammability Rating UL 94 V-0
- Small 6-Pin Package
- Tape & Reel, Surface Mount Version Available

Applications

- Sensor Circuitry
- Instrumentation
- Multiplexers
- Data Acquisition
- Electronic Switching
- I/O Subsystems
- Medical Equipment-Patient/Equipment Isolation
- Security
- Industrial Controls

Description

LCB717 is a single-pole normally closed (1-Form-B) solid state relay that uses optically coupled technology to provide an enhanced 3750V_{rms} isolation barrier between the input and the output of the relay. The efficient MOSFET switches use IXYS Integrated Circuits' patented OptoMOS architecture. The optically coupled output is controlled by a highly efficient infrared LED.

Approvals

- UL Recognized Component: File E76270
- TUV EN 62368-1: Certificate # B 082667 0008

Ordering Information

Part #	Description
LCB717	6-Lead DIP (50/Tube)
LCB717S	6-Lead Surface Mount (50/Tube)
LCB717STR	6-Lead Surface Mount (1000/Reel)

Pin Configuration

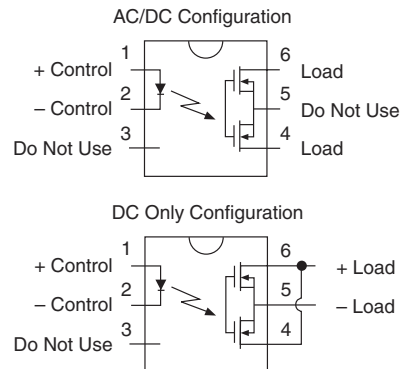

Switching Characteristics of Normally Closed Devices

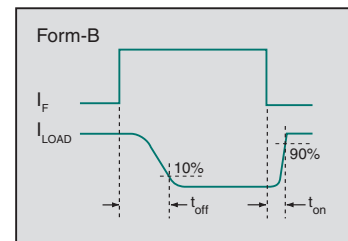

Absolute Maximum Ratings @ 25°C

Parameter	Ratings	Units
Blocking Voltage	30	V _P
Reverse Input Voltage	5	V
Input Control Current	50	mA
Peak (10ms)	1	A
Input Power Dissipation ¹	100	mW
Total Power Dissipation ²	800	mW
Isolation Voltage, Input to Output	3750	V _{rms}
ESD Rating, Human Body Model	8	kV
Operational Temperature, Ambient	-40 to +85	°C
Storage Temperature	-40 to +125	°C

¹ Derate linearly 1.33 mW / °C

² Derate output power linearly 6.67 mW / °C

Absolute Maximum Ratings are stress ratings. Stresses in excess of these ratings can cause permanent damage to the device. Functional operation of the device at conditions beyond those indicated in the operational sections of this data sheet is not implied.

Typical values are characteristic of the device at +25°C, and are the result of engineering evaluations. They are provided for information purposes only, and are not part of the manufacturing testing requirements.

Electrical Characteristics @ 25°C

Parameter	Conditions	Symbol	Min	Typ	Max	Units	
Output Characteristics							
Blocking Voltage	I _L =1μA	V _{DRM}	30	-	-	V _P	
Load Current	I _F =0mA	I _L	-	-	1.5	A _{rms} / A _{DC}	
Continuous, AC/DC Configuration			-	-	3	A _{DC}	
Continuous, DC Configuration			-	-	5	A	
Peak	I _F =0mA, t ≤ 10ms	I _{LPK}	-	-	5	A	
On-Resistance ¹	I _F =0mA, I _L =1.5A	R _{ON}	-	-	0.3	Ω	
AC/DC Configuration			I _F =0mA, I _L =3A	-	-		0.08
DC Configuration							
Switching Speeds	I _F =5mA, V _L =10V	t _{on}	-	-	2	ms	
Turn-On			t _{off}	-	-		5
Turn-Off							
Off-State Leakage Current	I _F =2mA, V _L =30V	I _{LEAK}	-	-	1	μA	
Output Capacitance	I _F =2mA, V _L =25V, f=1MHz	C _{OUT}	-	160	-	pF	
	I _F =2mA, V _L =1V, f=1MHz		-	459	-		
Input Characteristics							
Input Control Current to Activate ²	I _L =1A	I _F	-	-	2	mA	
Input Control Current to Deactivate	-	I _F	0.1	-	-	mA	
Input Voltage Drop	I _F =5mA	V _F	0.9	1.36	1.5	V	
Reverse Input Current	V _R =5V	I _R	-	-	10	μA	
Common Characteristics							
Capacitance, Input to Output	V _{IO} =0V, f=1MHz	C _{IO}	-	3	-	pF	

¹ Measurement taken within 1 second of on-time.

² For high temperature operation (>60°C) a minimum LED drive current of 4mA is recommended.

PERFORMANCE DATA *

Typical LED Forward Voltage Drop
(N=50, $I_f=5\text{mA}$)

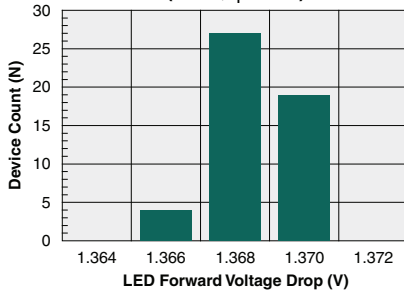

Typical Turn-On Time
(N=50, $I_f=5\text{mA}$, $I_L=100\text{mA}$)

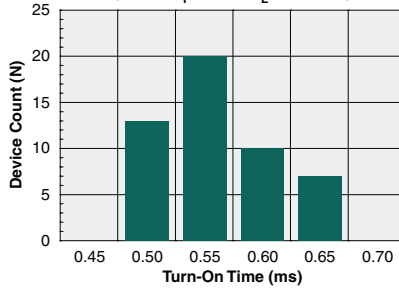

Typical Turn-Off Time
(N=50, $I_f=5\text{mA}$, $I_L=100\text{mA}$)

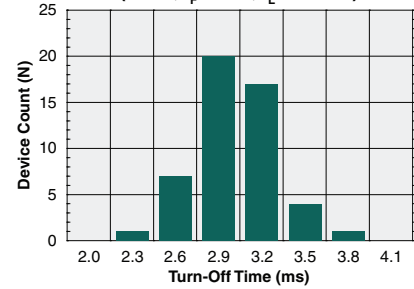

Typical LED Current to Operate
(N=50, $I_L=100\text{mA}$)

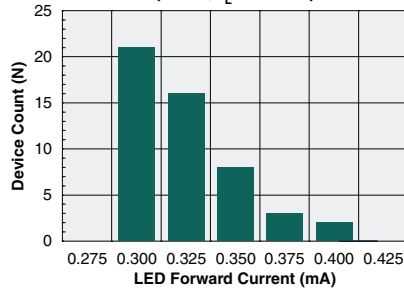

Typical Blocking Voltage Distribution
(N=50, $I_f=2\text{mA}$)

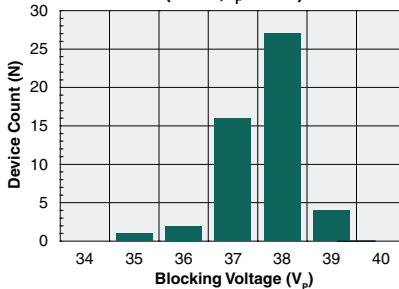

Typical On-Resistance Distribution
(N=50, $I_f=0\text{mA}$, $I_L=1\text{A}$)

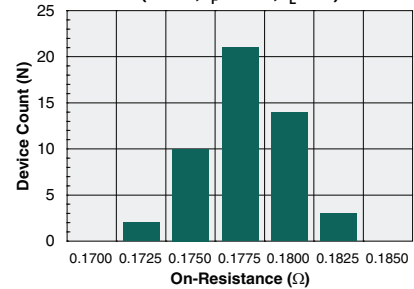

Typical LED Forward Voltage Drop
vs. Temperature

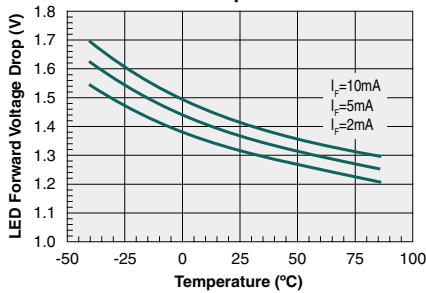

Typical Turn-On Time
vs. LED Forward Current
($I_L=100\text{mA}$)

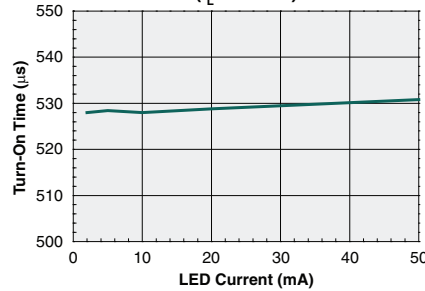

Typical Turn-Off Time
vs. LED Forward Current
($I_L=100\text{mA}$)

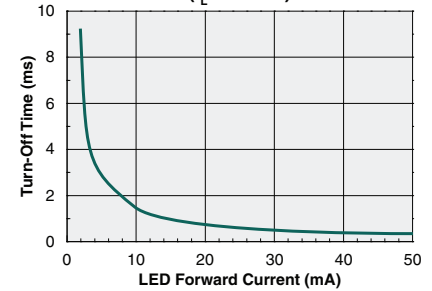

Typical LED Current to Operate
vs. Temperature
($I_L=750\text{mA}$)

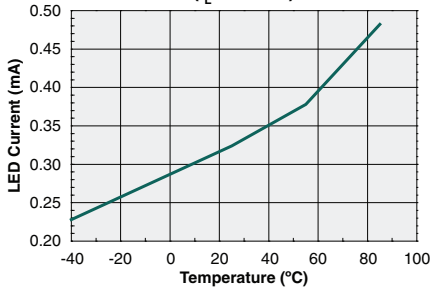

Typical Turn-On Time
vs. Temperature
($V_L=10\text{V}$, $I_L=100\text{mA}$)

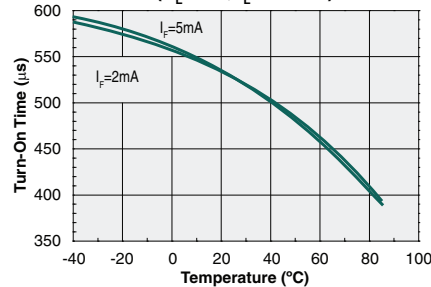

Typical Turn-Off Time
vs. Temperature
($I_L=100\text{mA}$)

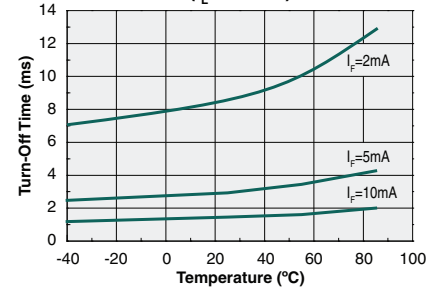

*Unless otherwise noted, data presented in these graphs is typical of device operation at 25°C.

PERFORMANCE DATA*

Typical On-Resistance vs. Temperature
AC/DC Configuration
($I_F=0mA$, $I_L=750mA$)

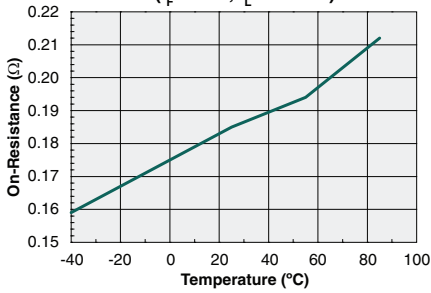

Typical Load Current vs. Load Voltage
AC/DC Configuration
($I_F=0mA$)

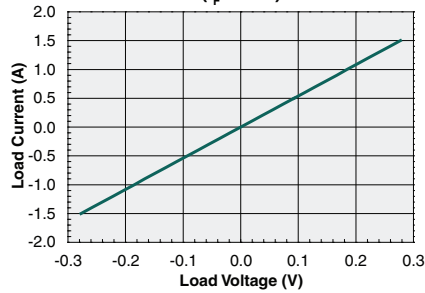

Maximum Load Current vs. Temperature
AC/DC Configuration
($I_F=0mA$)

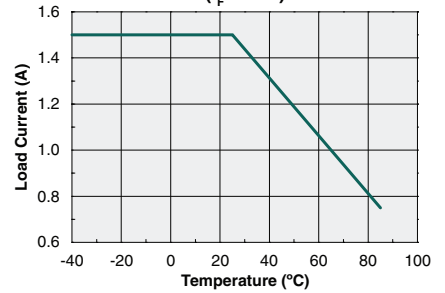

Typical On-Resistance vs. Temperature
DC-Only Configuration
($I_F=0mA$, $I_L=1.5A$)

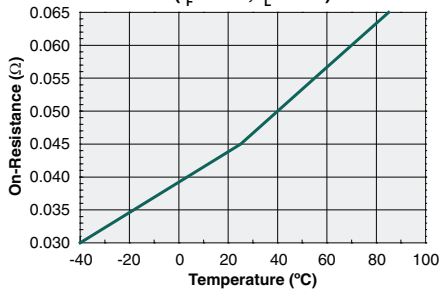

Typical Load Current vs. Load Voltage
DC-Only Configuration
($I_F=0mA$)

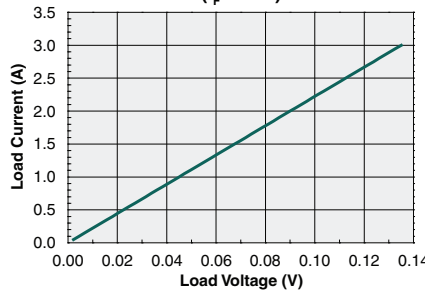

Maximum Load Current vs. Temperature
DC-Only Configuration
($I_F=0mA$)

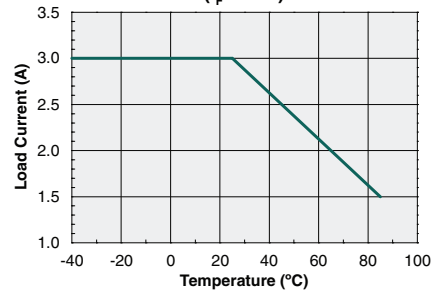

Typical Blocking Voltage
vs. Temperature
($I_F=4mA$)

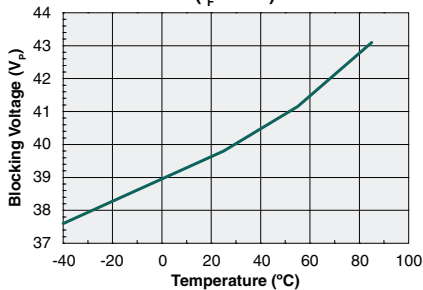

Leakage Current vs. Temperature
Measured Across Pins 4 & 6
($I_F=4mA$, $V_L=30V$)

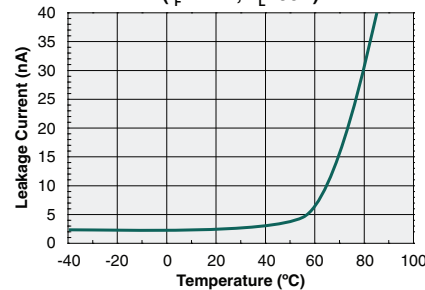

Output Capacitance vs. Load Voltage
($I_F=2mA$, $f=1MHz$)

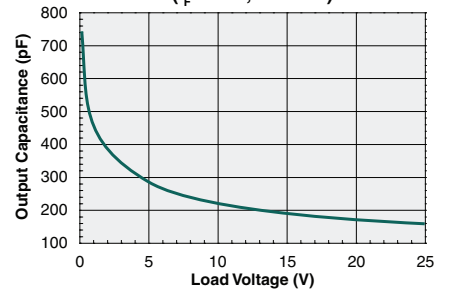

Energy Rating Curve

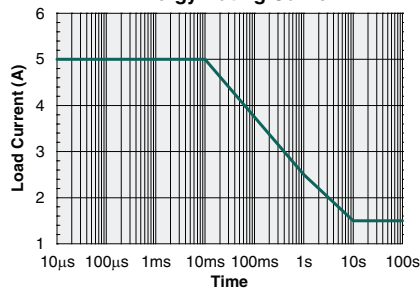

*Unless otherwise noted, data presented in these graphs is typical of device operation at 25°C.

Manufacturing Information

Moisture Sensitivity



All plastic encapsulated semiconductor packages are susceptible to moisture ingress. IXYS Integrated Circuits classifies its plastic encapsulated devices for moisture sensitivity according to the latest version of the joint industry standard, **IPC/JEDEC J-STD-020**, in force at the time of product evaluation. We test all of our products to the maximum conditions set forth in the standard, and guarantee proper operation of our devices when handled according to the limitations and information in that standard as well as to any limitations set forth in the information or standards referenced below.

Failure to adhere to the warnings or limitations as established by the listed specifications could result in reduced product performance, reduction of operable life, and/or reduction of overall reliability.

This product carries a **Moisture Sensitivity Level (MSL)** classification as shown below, and should be handled according to the requirements of the latest version of the joint industry standard **IPC/JEDEC J-STD-033**.

Device	Moisture Sensitivity Level (MSL) Classification
LCB717S	MSL 1

ESD Sensitivity



This product is ESD Sensitive, and should be handled according to the industry standard **JESD-625**.

Soldering Profile

Provided in the table below is the **IPC/JEDEC J-STD-020** Classification Temperature (T_C) and the maximum total dwell time (t_p) in all reflow processes that the body temperature of these surface mount devices may be ($T_C - 5$)°C or greater. The device's body temperature must not exceed the Classification Temperature at any time during reflow soldering processes.

Device	Classification Temperature (T_C)	Dwell Time (t_p)	Max Reflow Cycles
LCB717S	250°C	30 seconds	3

For through-hole devices, the maximum pin temperature and maximum dwell time through all solder waves is provided in the table below. Dwell time is the interval beginning when the pins are initially immersed into the solder wave until they exit the solder wave. For multiple waves, the dwell time is from entering the first wave until exiting the last wave. During this time, pin temperatures must not exceed the maximum temperature given in the table below. Body temperature of the device must not exceed the limit shown in the table below at any time during the soldering process.

Device	Maximum Pin Temperature	Maximum Body Temperature	Maximum Dwell Time	Wave Cycles
LCB717	260°C	250°C	10 seconds*	1

*Total cumulative duration of all waves.

Board Wash

IXYS Integrated Circuits recommends the use of no-clean flux formulations. Board washing to reduce or remove flux residue following the solder reflow process is acceptable provided proper precautions are taken to prevent damage to the device. These precautions include but are not limited to: using a low pressure wash and providing a follow up bake cycle sufficient to remove any moisture trapped within the device due to the washing process. Due to the variability of the wash parameters used to clean the board, determination of the bake temperature and duration necessary to remove the moisture trapped within the package is the responsibility of the user (assembler). Cleaning or drying methods that employ ultrasonic energy may damage the device and should not be used. Additionally, the device must not be exposed to halide flux or solvents.



Mechanical Dimensions

LCB717

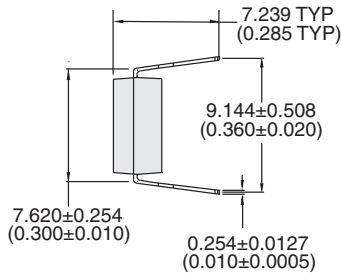
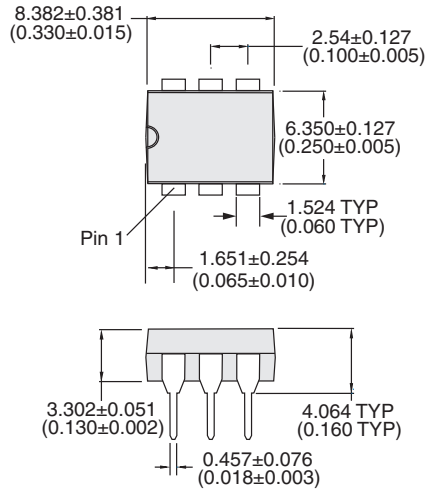

PCB Hole Pattern

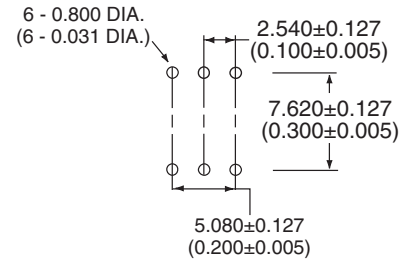

Controlling dimension: inches

Dimensions
 mm
 (inches)

LCB717S

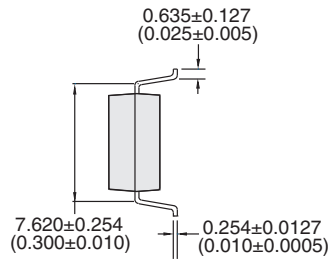
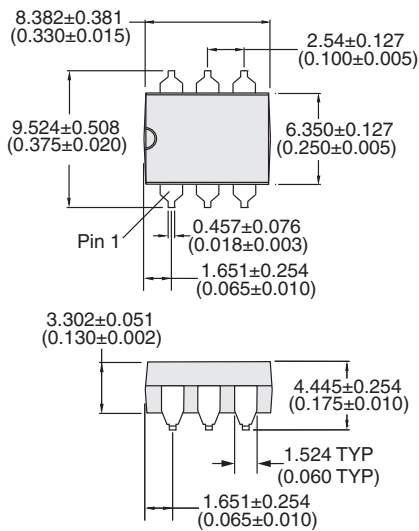

PCB Land Pattern

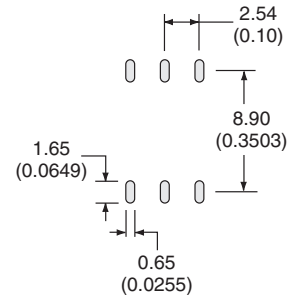

Controlling dimension: inches

Dimensions
 mm
 (inches)

LCB717S Tape & Reel

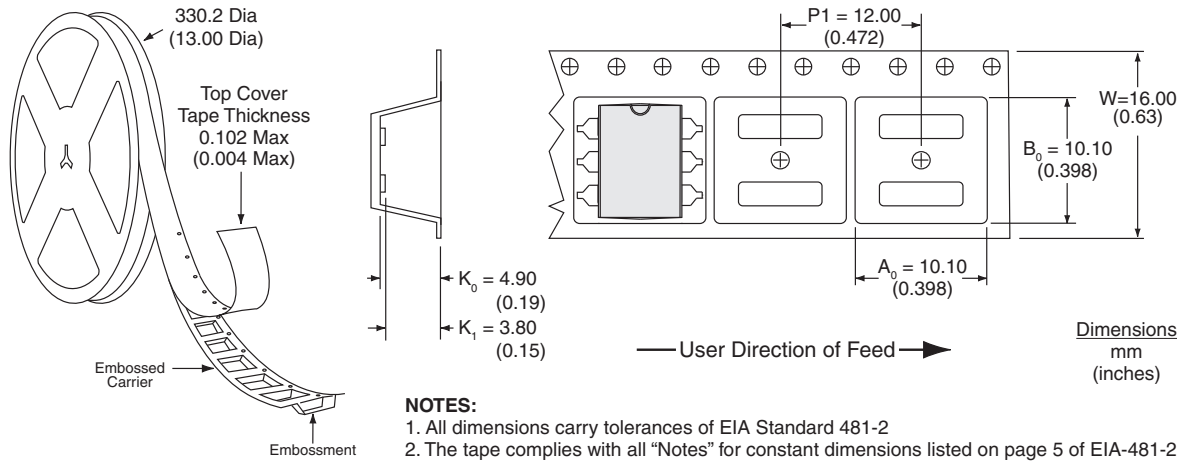

For additional information please visit our website at: <https://www.ixysic.com>