

INSTALLATION INSTRUCTIONS



Littelfuse

MotorSaver® **MODEL 777-FT**

DANGER!



HAZARDOUS VOLTAGES MAY BE PRESENT DURING INSTALLATION.
Electrical shock can cause death or serious injury.



Installation should be done by qualified personnel following all national, state and local electrical codes.

**BE SURE POWER IS DISCONNECTED PRIOR TO INSTALLATION!
FOLLOW NATIONAL, STATE, AND LOCAL CODES!
READ THESE INSTRUCTIONS ENTIRELY BEFORE INSTALLATION!**

! WARNING !

UNEXPECTED OUTPUT ACTUATION CAN OCCUR.

Use hard-wired safety interlocks where personnel and/or equipment hazards exist.
Failure to follow this instruction can result in death, injury or equipment damage.

Littelfuse electronic overload relays are fully programmable for customized protection with a digital readout and RS-485 communications. The 777-FT also has a fast linear trip mode.

CONNECTIONS

1. Using the four corner tabs or the DIN rail mounting bracket, mount the unit near the magnetic contactor. To use the DIN rail bracket, hook the top clip first, then apply downward pressure until the lower clip “clicks” onto the rail.
- 2.1 For amperages from 26-90 amps, insert the motor conductors from the top of the unit through the holes marked ‘A’, ‘B’, and ‘C’. Make certain that the conductor through each hole corresponds to the right motor conductor (i.e. the ‘A’ phase conductor should go through the ‘A’ round hole). See Figure 1 for a typical wiring diagram.
- 2.2 For amperages less than 26 amps, loop the motor conductors according to Table 1. Figure 2 shows an example of the looping required for current ranging from 8.1 to 12 amps (MULT=3).
- 2.3 For amperages greater than 90 amps, external CT’s (current transformers) are required. SymCom recommends CT’s with terminals be used for ease of installation. All CT secondaries must make five passes through the round holes on the MotorSaver. See Figure 3 for a typical wiring diagram using external CT’s.

NOTE: Pay close attention to the diagrams to eliminate any power factor errors.

3. Connect the three phase power from the line side of the contactor to ‘L1’, ‘L2’, and ‘L3’ terminals using 12-18AWG copper wire.
4. Connect the control circuit wires to the appropriate terminals. The relay is a fail safe design so the ‘NO’ contact should be in series with the coil on the contactor for motor control (see Figure 4). For alarm circuits, the ‘NC’ contact is in series with the alarm circuitry (not shown).



Littelfuse

Littelfuse.com/777
© 2023 Littelfuse

II-777-FT-B

FULL LOAD AMPS	NUMBER OF LOOPS	NUMBER OF CONDUCTORS THROUGH A, B, and C	MULT PROGRAM SETTING
2.0 - 2.5	9	10	10
2.6 - 3.0	8	9	9
3.1 - 3.5	7	8	8
3.6 - 4.0	6	7	7
4.1 - 5.0	5	6	6
5.1 - 6.0	4	5	5
6.1 - 8.0	3	4	4
8.1 - 12	2	3	3
13 - 25	1	2	2
26 - 90	0	1	1
EXTERNAL CTs REQUIRED. SEE FIGURE 2 FOR WIRING EXTERNAL CTs.			
91 - 110	4	5	100 (100:5 CT)
111 - 160	4	5	150 (150:5 CT)
161 - 220	4	5	200 (200:5 CT)
221 - 320	4	5	300 (300:5 CT)
321 - 420	4	5	400 (400:5 CT)
421 - 520	4	5	500 (500:5 CT)
521 - 620	4	5	600 (600:5 CT)
621 - 800	4	5	800 (800:5 CT)

TABLE 1: WIRING CONFIGURATION BASED ON MOTOR FLA

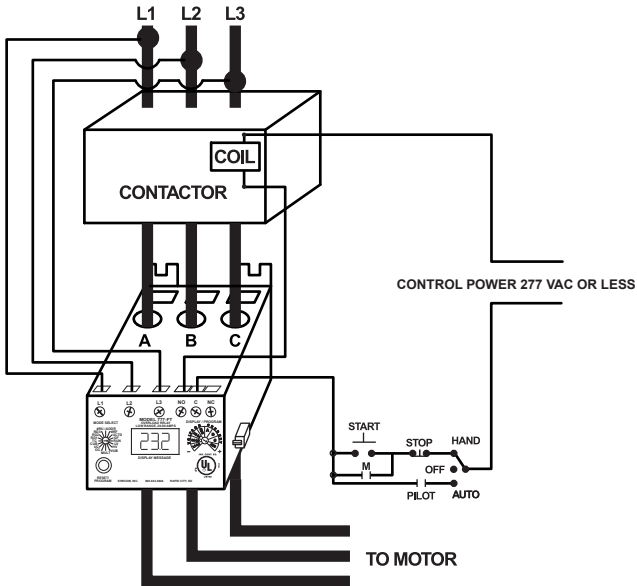

FIGURE 1: TYPICAL WIRING DIAGRAM FOR 26-90 FLA

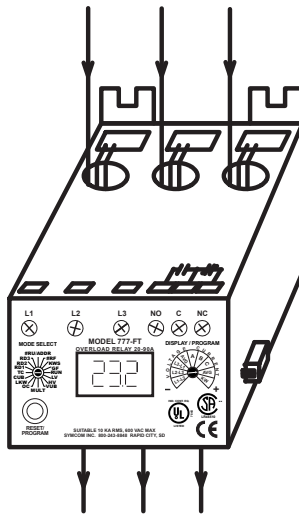

FIGURE 2: LOOPING EXAMPLE SHOWING 3 CONDUCTORS (2 LOOPS) WITH A MULT OF 3

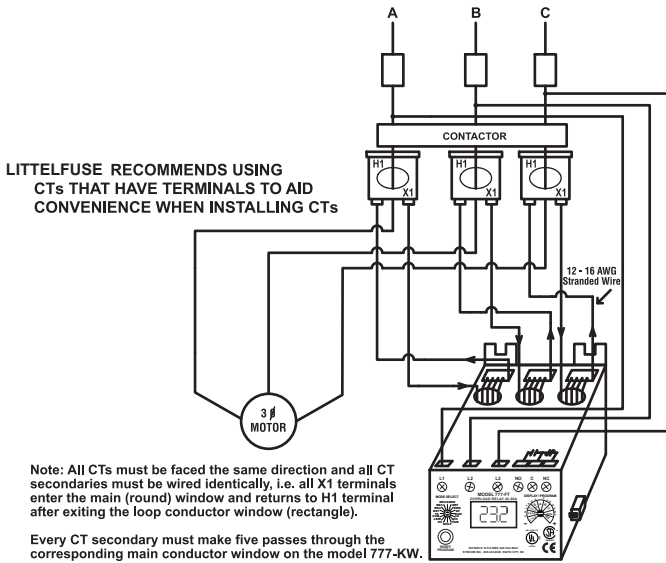

FIGURE 3: TYPICAL WIRING DIAGRAM USING EXTERNAL CTs

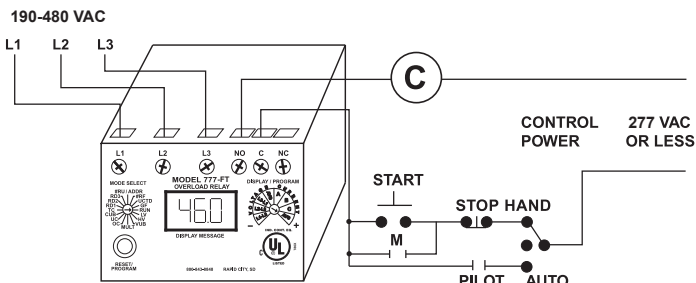

FIGURE 4: TYPICAL CONTROL WIRING DIAGRAM

Operation

The relay operation of 777-FT overload relay is a fail safe design. This means when everything is within the limits programmed into the unit, the relay will energize; the normally open (NO) contact will close and the normally closed (NC) contact will open. Once the unit has been wired and programmed, the unit is ready to operate. Turn the mode select to the “RUN” position. The display will show “RUN” alternating with some number (the numbers displayed will be the number corresponding to where the “DISPLAY/PROGRAM” knob is pointed). It will do this for the amount of time programmed into “RD1”. After this time has expired, the relay will energize (normally open will close and normally closed contact will open). If something else is in the display, see the troubleshooting section for more information. If the mode select is taken out of the “RUN” position, the units relay will de-energize.

PROGRAMMING

1. Select the feature to program by rotating the “MODE SELECT” switch to the desired position. The “MULT” setting must be programmed before any of the current settings to ensure proper display of actual current setpoints. Therefore, Littelfuse recommends programming the “LV” setting first, then move clockwise through the positions to complete the process.
2. Push and hold the RESET / PROGRAM button.
3. Rotate the DISPLAY / PROGRAM adjustment to the desired setting of the feature as shown in the LED display.
4. Release the RESET / PROGRAM button. The unit is programmed when the button is released.
5. Continue steps 1-4 until all features are programmed.

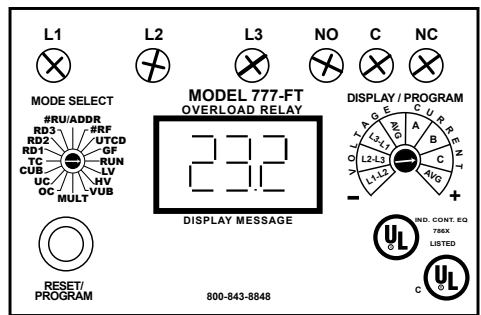

NOTE: Some “MODE SELECT” positions are dual function such as the “#RU / ADDR” position. When the “MODE SELECT” switch is pointed at “#RU / ADDR,” you may view and program “#RU” and “ADDR.” To view the two settings rotate the “DISPLAY / PROGRAM” adjustment across its entire range. You will see the “#RU” setting when the “DISPLAY / PROGRAM” adjustment is between approximately 7 O’Clock and 11 O’Clock. You will see the “ADDR” setting when the “DISPLAY/PROGRAM” adjustment is between approximately 11 O’Clock and 5 O’Clock. To program “#RU” or “ADDR,” follow the programming instructions above. The “#RU” setting will only be programmed when the “DISPLAY / PROGRAM” adjustment is between approximately 7 O’Clock and 11 O’Clock. Likewise, the “ADDR” setting will only be programmed when the “DISPLAY/PROGRAM” adjustment is between approximately 11 O’Clock and 5 O’Clock. “ADDR” settings will be an “A” followed by a number between 1 and 99.

FAST LINEAR TRIP MODE

The Fast Linear Trip Mode provides an adjustable linear trip that can be used for very quick or very slow trips. The Model 777-FT family offers superior protection for sensitive motors, quick trips in test panels, and fast trips to protect high torque systems.

When the Fast Linear Trip Mode is activated (TC = J00), two new parameters, Motor Acceleration time and Over Current Trip Delay are viewed and programmed in the RD1 and RD2 positions. The RD1 and RD2 setpoints are still valid, but can only be viewed and programmed by setting the trip class to any other class other than J00.

Note: Ensure Trip Class is set appropriately when changing RD1, RD2, MA, or OCTD.

When the Fast Linear Trip Mode is used, the restart delays (RD1, RD2, and RD3) will be reduced by approximately 50%. Example: RD1 setting = 010; RD1 time = 5 seconds.

PROGRAMMABLE PARAMETERS

NOTE: The unit can be programmed prior to installation by applying 120VAC to terminals 'L1' and 'L2'.

The programmable parameters are the values the user must program to provide the correct protection for the application. All parameters are actual values except the "VUB" and "CUB" settings, which are percentages. The range these parameters can be programmed to is found in the specifications at the end of the manual.

THE FOLLOWING ARE GENERAL RECOMMENDATIONS. THE MOTOR MANUFACTURER SHOULD BE CONSULTED FOR EXACT SETTINGS.

LV/HV-The recommended settings for "LV" (low voltage) and "HV" (high voltage) depend on many factors such as motor usage, motor size, environmental factors and tolerance of the motor. The motor manufacturer should be consulted for "HV" and "LV" settings. However, the NEMA MG1 standard recommends that "LV" and "HV" be set to no more than 10% of the motor's nameplate voltage. The setting can be determined by multiplying the motor's nameplate voltage by the recommended percent over and under voltage (eg. The motor nameplate voltage is 4160 V. Potential transformer(s) is 4160V/120V. Therefore, set "LV" to $0.9 \times 120 = 108$ and "HV" to $1.10 \times 120 = 132$). "LV" can not be set higher than "HV", so "HV" may have to be adjusted higher before the proper "LV" setting can be programmed.

VUB- "VUB" is the voltage unbalance trip point. The NEMA MG1 standard does not recommend operating a motor above a 1% voltage unbalance without derating the motor. Voltage unbalance is determined from the following formula:

$$\text{Percent Unbalance} = \frac{\text{Maximum Deviation from the Average}}{\text{Average}} \times 100$$

Example: The measured line-to-line voltages are 203, 210, and 212.

$$\text{Average} = \frac{203 + 210 + 212}{3} = 208.3$$

The maximum deviation from the average is the largest difference between the average voltage (208.3) and any one voltage reading.

$$208.3 - 203 = 5.3 \quad 210 - 208.3 = 1.7 \quad 212 - 208.3 = 3.7$$

The maximum deviation from the average is 5.3.

$$\frac{5.3}{208.3} \times 100 = 2.5\% \text{ Unbalance}$$

Note: A setting of “999” in this position will disable single phasing and voltage unbalance protection.

MULT- “MULT” is the multiplication factor for determining true current settings based on current transformer ratio of external CTs. The appropriate number can be determined from Table No. 1 on page 2. “MULT” must be correctly programmed in order to accurately program the current settings.

OC- Represents the manufacturer’s maximum Service Factor Amperage (SFA). The “OC” (overcurrent) setting depends on many factors such as motor usage, motor size, environmental factors and tolerance of the motor. The motor manufacturer should be consulted for “OC” settings. However, “OC” is typically between 110% and 125% of Full Load Amperage (FLA).

UC- The “UC” (undercurrent) setting is typically set to 80% of full load amperage (FLA). The overload relay with a “UC” setting of 80% of FLA will typically detect a loss of load for many pumps and motors such as a dry well condition for submersible pumps. The “UC” setting may be set to 0.00 to disable undercurrent (loss of load) protection.

CUB- “CUB” is the current unbalance trip point. Most motor manufacturers recommend operating under no more than 5% current unbalance, therefore, a setting of “5” is a good place to start. However, your motor manufacturer should be contacted for exact settings.

Note: Current unbalance is calculated the same way as voltage unbalance.

Note: A setting of “999” in this position will eliminate single phasing and current unbalance protection.

TC- “TC” designates the trip class for overload protection. The trip class defines the trip delay when an overload is detected. Trip class is determined by the type of motor and application. Your motor manufacturer should be consulted for the proper setting. Table No. 2 on page 9 shows the trip class and a general description of the applications.

RD1- “RD1” is the rapid cycle timer. To view and adjust RD1, TC must not be J00. It will engage when the motor is first powered-up or after the motor controls shut down the motor. An “RD1” setting of 20-30 seconds will generally protect the motor from rapid, successive power outages or short cycling caused by the motor controls. A setting of 0 (zero) will allow the motor to start immediately after power-up or after a normal shutdown.

Note: In linear trip mode (TC = J00), the RD1 time is approximately 50% of the normal RD1 time. Example: If RD1 is set to 10 seconds, the TC = J00, then the actual RD1 time in the linear trip mode will be 5 seconds.

Note: Display increments by 2.

RD2- “RD2” is the restart delay after the overload relay trips on current unbalance, single phasing, and overload (if “oc” is programmed in “#RF”). To view and adjust RD2, TC must not be J00. This delay allows the motor to cool down after experiencing the above faults. It is also known as a motor cool down timer. Your motor manufacturer should be contacted to determine this setting. Under normal circumstances, a setting of 30-60 minutes will give the motor enough time to cool down between faults. The Motor Manufacturer should be consulted for their recommendation.

MA- In linear trip mode (TC = J00), the RD1 position becomes the motor acceleration time. To view and adjust MA, TC must be J00. The motor acceleration time is related to the load on a motor. For high inertia loads such as fly wheels or conveyor systems, the motor acceleration time is considerably longer than low inertia loads such as submersible pumps. Therefore, “MA” is typically set higher for high inertia loads and lower for low inertia loads. During the motor acceleration time, the linear overcurrent trip feature is ignored. Therefore, it is important not to set “MA” too high because damage could occur to the motor. The minimum MA time is 0.158 seconds. The actual MA time is the display value times 0.158 seconds (± 0.315 seconds). Example: If MA is set to 60, MA Time = $(60 \times 0.158 \text{ seconds}) = 9.48 \text{ seconds} \pm 0.315 \text{ seconds}$.

Note: In linear trip mode (TC = J00), the RD2 time is approximately 50% of the normal RD2 time. Example: If RD2 is set to 10 minutes, the TC = J00, then the actual RD2 time in the linear trip mode will be 5 minutes.

OCTD- In linear trip mode (TC = J00), the RD2 position becomes the Overcurrent Trip Delay. To view and adjust OCTD, TC must be J00. This setting represents the maximum time that the unit will tolerate an overcurrent condition before tripping. The minimum OCTD time is 0.158 seconds. The actual OCTD is the display value times 0.158 seconds (± 0.315 seconds). Example: If OCTD is set to 6, OCTD = $(6 \times 0.158 \text{ seconds}) = 0.948 \text{ seconds} \pm 0.315 \text{ seconds}$.

RD3- “RD3” is the restart delay after an undercurrent. It is also known as a dry well recovery timer and is usually used in submersible pumping applications. The setting of “RD3” depends on the recovery time of the water well and varies widely from application to application.

Note: In linear trip mode (TC = J00), the RD3 time is approximately 50% of the normal RD3 time. Example: If RD3 is set to 30 minutes, the TC = J00, then the actual RD3 time in the linear trip mode will be 15 minutes.

#RU- “#RU” is the number of successive restart attempts allowed after an under current fault before the overload relay requires manual reset. A setting of “0” is manual reset and a setting of “A” is continuously automatic reset.

ADDR- “ADDR” is the address setting for RS-485 communications. Available settings are from A01 - A99. This setting is programmed on the right half of the PROGRAM/DISPLAY adjustment (see programming instruction note for explanation of dual function settings). You may ignore this setting if RS-485 communications are not used.

#RF- “#RF” is the number of successive restart attempts allowed after a current unbalance, single phasing or overload fault. The following settings are available: “0”, “1”, “oc1”, “2”, “oc2”, “3”, “oc3”, “4”, “oc4”, “A”, and “ocA”. A setting which includes “oc” will allow the overload relay to automatically reset after an overload fault (eg., a setting of “oc2” will allow the overload relay to reset 2 times after an overload condition, current unbalance, or single phasing before locking out if an overload condition, current unbalance, or single phasing is detected within one minute after restarting). A setting which does not include “oc” requires a manual reset for all overload faults. A setting of “0” is manual reset and a setting of “A” is continuously automatic restart.

UCTD- “UCTD” is the undercurrent trip delay timer. This setting represents the maximum time that the unit will tolerate an under current condition. Typically, UCTD is set to 2 - 4 seconds.

GF- “GF” is the ground fault protection amperage threshold. This setting detects a leakage current to ground and signals an insulation breakdown in the system. The “GF” setting should be some where between 10% and 20% of the full load motor current. Short circuit protection is provided by separate branch protective devices such as circuit breakers or fuses. Ground fault protection is a Class II ground fault protector and should not be used for personnel safety, but can be used to indicate motor degradation for maintenance purposes.

Trip Class	Application Description
5	Small fractional horsepower motors where acceleration times are almost instantaneous or where extremely quick trip times are required.
10	(Fast Trip) Hermetic refrigerant motors, compressors, submersible pumps, and general purpose motors that reach rated speed in less than 4 seconds.
15	Certain specialized applications.
20	(Standard Trip) Most NEMA-rated general purpose motors will be protected by this setting.
30	(Slow Trip) Motors with long acceleration times (>10 seconds) or high inertia loads.
J Prefix	Programming any of the above trip classes with the J prefix will enable jam protection. This additional protection is enabled 1 minute after the motor starts and provides a 2-second trip time for motors exceeding 400% SFA, regardless of trip class.
J00	(Fast Linear Trip Mode) This setting provides an adjustable linear trip that can be used for very quick or very slow trips. This is used for sensitive motors, quick trips in test panels, and fast trips to protect high torque systems.

TABLE NO. 2: TRIP CLASS DESCRIPTIONS

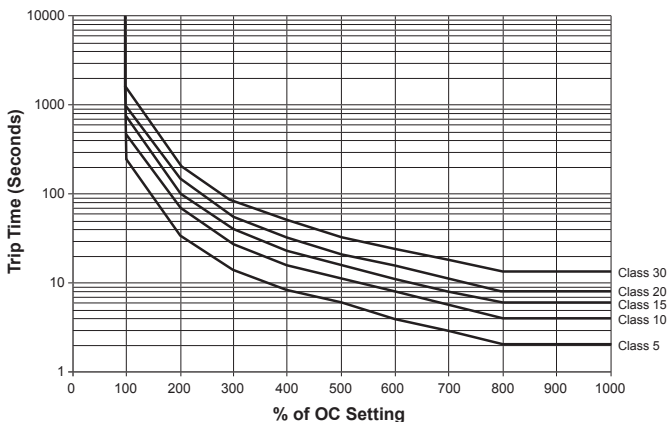

FIGURE NO. 4: OVERLOAD TRIP CLASSES AND TRIP TIMES

PROGRAMMING EXAMPLES

#1 - Motor to be protected: 3Ø, 230 volt, 5 hp submersible pump with a full load amperage of 15.9 and a maximum service factor amperage of 18.2. Use the following calculations and reasoning to determine the appropriate settings for this application.

- LV- $230 \times 0.90 = 207$
- HV- $230 \times 1.10 = 253$
- VUB- Manufacturer suggest 5%
- MULT-From Table No. 1, MULT = 2 (2 conductors, 1 loop)
- OC- Service Factor Amperage = 18.2
- UC- $FLA \times 0.80 = 15.9 \times 0.80 = 12.7$
- CUB- Manufacturer suggest 5%
- TC- TC = 010 (To program RD1 and RD2), then TC = J00
- RD1- To protect the pump from rapid cycling and reduce the number of starts per hour, RD1 = 10 (Display value) $\times 0.5 = 5$ seconds.
- RD2- Since the motor is small and submerged in water it will generally cool off quickly, RD2 = $10 \times 0.5 = 5$ Minutes.
- MA- MA = 64 (Displayed value) $\times 0.158 = 10.1$ Seconds.
- OCTD-OCTD = 10 (Displayed value) $\times 0.158 = 1.58$ Seconds.
- RD3- The well history shows that it will fully recover in 2 hours.
RD3 = $240 \times 0.5 = 120$ Minutes
- #RU- In this application, we know that the well will eventually recharge itself, #RU = A.
- #RF- This well is known for sand to jam the impeller, therefore "oc" should be included so that the pump will attempt to automatically restart after an overloaded condition. History shows that 1 start attempt usually clears the sand out of the impeller. #RF = oc1
- UCTD- UCTD = 10
- GF- Because it may take several days to get a new pump motor and schedule for maintenance personnel to remove and replace the pump motor, GF setting of 10% of full load amperage will give the well owner enough time to prepare for pump replacement.
GF = $56.2A \times 0.10 = 5.6$

#2- Motor To Be Protected: 3Ø, 460 Volt, 25 Hp air compressor with a full load amperage rating of 34A and maximum service factor amps of 37.4. Use the following calculations and reasoning to determine the appropriate settings for this application.

- LV- $460 \times 0.90 = 414$
- HV- $460 \times 1.10 = 506$
- VUB- Standard NEMA motor = 5
- MULT-From Table No. 1 = 1
- OC- Service Factor Amperage = 37.4
- UC- $FLA \times 0.80 = 34A \times 0.80 = 27.2$
- CUB- Standard NEMA motor = 5
- TC- General purpose motor = 20
- RD1- Since this compressor takes about 10 seconds to bleed off excess pressure after a shutdown, setting RD1 = 20 will allow the compressor to unload before being restarted.
- RD2- Because the motor may be hot from running in an unbalance or single phase condition, a motor cool down time of 10 minutes, RD2 = 10, should be appropriate.

- RD3/#RU- Because an undercurrent would signal a serious problem in this application (a broken shaft or belt), #RU should be set = 0 for a manual reset. Therefore, RD3 does not have any function
- #RF- Because an overload (overcurrent) fault signals a serious problem in this application (e.g., worn bearings), “oc” should not be included in the #RF setting so that a manual reset after an overload fault is required. A #RF=1 will give the system 1 chance to recover from an unbalance or single phasing problem before manual reset is required.
- UCTD-Setting UCTD = 5 will allow normal operation and not allow the motor to run too long in a failure mode.
- GF- A ground fault setting of 15% of full load amps will be a significant indicator that the motor should be evaluated for repair or replacement. Therefore, $GF = 34A \times 0.15 = 5.1$.

MULTI-FUNCTION SYSTEM DISPLAY

The output display can show various system operating parameters:

- L1-L2 Voltage •L2-L3 Voltage •L3-L1 Voltage •Average Voltage
- Average Current •AØ Current •BØ Current •CØ Current

When the “MODE SELECT” switch is in the “RUN” position, the LED will display one of the above operating parameters. To select or change the displayed parameter, turn the “DISPLAY / PROGRAM” adjustment to the desired position as shown on the label.

The multi-function display also announces system faults such as low voltage, high voltage, single phasing, unbalance, and reverse phasing errors. Any time the “MODE SELECT” switch is in the “RUN” position, the “RESET / PROGRAM” button may be pushed to view the last fault which occurred. Table No. 3 shows the possible messages.

DISPLAYED MESSAGE	MEANING
oc	Tripped on Overcurrent
SP	Tripped on Single-Phasing
ub	Tripped on Unbalance
uc	Tripped on Undercurrent
CF	Tripped on Contactor Failure (Current Unbalance without Voltage Unbalance)
GrF	Tripped on Ground Fault
HI	Preventing the motor from starting due to High Voltage
Lo	Preventing the motor from starting due to Low Voltage
rP	Preventing the motor from starting due to Reverse Phasing
oFF	A stop command was issued from a remote source

TABLE NO.3: DISPLAY MESSAGES

TROUBLESHOOTING

PROBLEM	SOLUTION
The unit will not start. Display alternates "rP" with the "DISPLAY / PROGRAM" switch value.	The voltage inputs are reverse phased. If this is the initial start up, swap the "L1" and "L3" leads to correct the problem. If the overload relay has been previously running, the power system has been reverse phased. Check the phase sequence of the incoming power lines.
The unit will not start. Display alternates "SP", "uB", "HI", or "Lo with "DISPLAY / PROGRAM" switch parameter value.	The incoming voltage is not within the limits programmed in the "VUB", "HV", and "LV" settings. Adjust the "DISPLAY / PROGRAM" switch to read the incoming line voltage values. Correct the incoming power problem and check programmed limits to verify they are correct.
Display alternates "SP", "uB", or "oc" with "RUN".	The overload relay has tripped on the fault shown on the display and is timing down "RD2" before restarting.
Display alternates "uc" with "RUN".	The overload relay has tripped on undercurrent and is timing down "RD3" before restarting. If undercurrent is not a normal condition for this installation, check for broken shafts, broken belts, etc.
Display is showing a solid "SP", "uB", or "oc".	The unit has tripped on the fault shown and manual reset is required because of the programmed setting in "#RF". Check the system for problems that would produce the single phase, overload, or current unbalance fault like a jam.
Display is showing a solid "uc".	The unit has tripped on undercurrent and a manual reset is required because of the setting in "#RU". Check the system for problems that would produce a loss of load like a broken belt or a pump is out of liquid.
Display is showing a solid "CF".	The unit has tripped on a single phasing of the current, but was not single phased by the incoming power. Check for damaged contacts or loose wiring.

Any questions or comments call 1-800-843-8848 or email techline@littelfuse.com

COMMUNICATIONS PORT / REMOTE RESET

The Model 777-FT comes standard with a 9-pin sub-D connector for remote communications. The Model 777-FT supports the RS-485 communication standard using the MODBUS protocol. This standard allows up to 99 Model 777-FTs to be controlled and monitored from a single remote personal computer. Control and monitoring is also possible from Littelfuse RM-1000 and RM-2000 PLC and SCADA systems using the RS-485 standard and MODBUS protocol can also be used.

NOTE: An RS-485MS-2W module is required to operate the communications bus. (Refer to RS-485MS-2W Installation Instructions for more information on this subject). The communications port also provides connections for remote reset as shown in Figure No. 6.

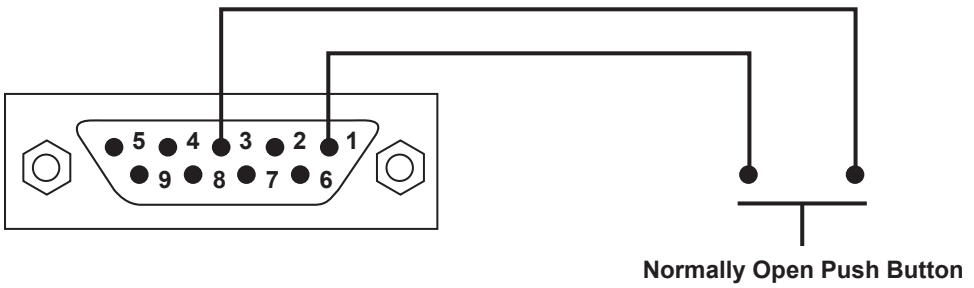

FIGURE NO. 6: REMOTE RESET CONNECTIONS

CLEARING LAST FAULT

The last fault stored can be cleared on the unit. This procedure is outline as follows:

1. Rotate the Mode Select Switch to GF .
2. Press and hold the Reset/Program Button. Adjust the Display/Program adjustment until cLr appears on the display. Release the Reset/Program Button.

To verify the last fault was cleared, place the Mode Select switch in the Run position. Then press and hold the Reset/Program Button, cLr should be on the display.

TAMPER GUARD

The unit can be protected from unauthorized program changes by locking in the setpoints.

This procedure is outlines as follows:

1. Rotate the Mode Select switch to GF .
2. Rotate Display/Program adjustment fully clockwise.
3. Press and hold the Reset Button. Adjust the Display/Program adjustment until Loc appears in the display.
4. Release the Reset Button.
5. Turn Mode Select switch to run .

The program is now locked, but all settings can be viewed. The unit can be unlocked by following the procedure above except step three. This step should say: Press and hold the Reset Button. Adjust the Display/Program adjustment until unL appears in the display.

SPECIFICATIONS

ELECTRICAL	
Input Voltage	190 - 480 VAC, 3 ϕ (Programmable)
Frequency	50 - 60 Hz
Motor Full Load Amp Range	2-25 amps 3 ϕ (loops required) 25-90 amps 3 ϕ (direct) 80-800 amps 3 ϕ (External CTs)
Power Consumption	10 W (Maximum)
Output Contact Rating SPDT (Form C)	Pilot Duty Rating: 480 VA @ 240 VAC General Purpose: 10 A @ 240 VAC
Expected Life	
Mechanical	1 x 10 ⁶ Operations
Electrical	1 x 10 ⁵ Operations at rated load
Accuracy at 25° C (77°F)	
Voltage	±1%
Current	±3% plus CT accuracy
GF Current	±15%
Timing	5% ±1 second
Repeatability	
Voltage	±0.5% of nominal voltage
Current	±1% of nominal current
TRIP TIMES (Those not shown have user selectable trip times)	
Ground Fault	Trip Time
101-200% of Setpoint	8 Seconds ±1 Second
201-300% of Setpoint	4 Seconds ±1 Second
301-400% of Setpoint	3 Seconds ±1 Second
401% or Greater of Setpoint	2 Seconds ±1 Second
Current Unbalance	Trip Time
1% Over Setpoint	30 Seconds
2% Over Setpoint	15 Seconds
3% Over Setpoint	10 Seconds
4% Over Setpoint	7.5 Seconds
5% Over Setpoint	6 Seconds
6% Over Setpoint	5 Seconds
10% Over Setpoint	3 Seconds
15% Over Setpoint	2 Seconds
SAFETY MARKS	
UL	UL508, UL1053

Standards Passed	
Electrostatic Discharge (ESD)	IEC 1000-4-2, Level 3, 6 KV Contact, 8 KV Air
Radio Frequency Immunity (RFI), Conducted	IEC 1000-4-6, Level 3 10 V/M
Radio Frequency Immunity (RFI), Radiated	IEC 1000-4-3, Level 3 10 V/M
Fast Transient Burst	IEC 1000-4-4, Level 3, 3.5 KV Input Power
Surge	
IEC	1000-4-5 Level 3, 2 KV Line-to-Line Level 4, 4 KV Line-to-Ground
ANSI / IEEE	C62.41 Surge and Ring Wave Compliance to a Level of 6 KV Line-to-Line
Hi-Potential Test	Meets UL508 (2 x Rated Voltage + 1000 Volts for 1 Minute)
Vibration	IEC 68-2-6, 10-55 Hz, 1 mm Peak-to-Peak, 2 Hours, 3 Axis
Shock	IEC 68-2-27, 30 G, 3 Axis, 11 mS Duration, Half Sine Pulse
MECHANICAL	
Dimensions	3.0" H x 5.1" D x 3.6" W
Terminal Torque	7 inch/pounds
Enclosure Material	Polycarbonate
Weight	1.2 pounds
Maximum Conductor Size Through Unit	0.65" with insulation
ENVIRONMENTAL	
Temperature Range	Ambient Operating: -20° - 70° C (-4° - 158° F) Ambient Storage: -40° - 80° C (-40° - 176° F)
Pollution Degree	3
Class of Protection	IP20, NEMA 1

PROGRAMMABLE OPERATING POINTS	
LV- Low Voltage Threshold	170 V - HV Setting
HV - High Voltage Threshold	LV Setting - 528 V
VUB - Voltage Unbalance Threshold	2 - 15% or 999 (OFF)
MULT - # conductors or CT Ratio (xxx:5)	1-10 conductors or 100-800 Ratio
OC - Overcurrent Threshold	(20 to 100 A) ÷ MULT or 80 to 120% of CT Ratio
UC - Undercurrent Threshold	(0, 10 to 98 A) ÷ MULT or 40 to 100% of CT Primary
CUB - Current Unbalance Threshold	2 - 25% or 999 (OFF)
TC - Overcurrent Trip Class**	5, J5, 10, J10, 15, J15, 20, J20, 30, J30, or J00
RD1 - Rapid Cycle Timer	0, 2 - 500 Seconds (x 0.5 if TC = J00)
MA - Motor Acceleration Timer	0 - 250 x (0.158 through 0.315) Seconds
RD2 - Motor Cool Down Timer	2 - 500 Minutes (x 0.5 if TC = J00)
OCTD - Overcurrent Trip Delay (Linear)	2-250 x (0.158 - 0.315) Seconds
RD3 - Dry Well Recovery Timer	2 - 500 Minutes (x 0.5 if TC = J00)
#RU - Number of Restarts After UC Fault	0, 1, 2, 3, 4, or A (Automatic)
ADDR - RS-485 Address	A01 - A99
#RF - Number of Restarts After All Faults Except UC***	0, 1, oc1, 2, oc2, 3, oc3, 4, oc4, A, or ocA
UCTD - Undercurrent Trip Delay	2 - 60 Seconds
GF - Ground Fault Current Threshold	(3-20 A) ÷ MULT or 10 - 30% of CT Primary or OFF

NOTES: 777-FT Overload Relay can be preprogrammed prior to installation by applying 120 VAC between the L1 and L2 terminals.

**** If J Prefix is displayed in trip class setting, jam protection is enabled.**

***** If “oc” is displayed in the #RF setting, then Over Current will be included as a normal fault and the relay will automatically restart after RD2 expires, otherwise, manual reset is required after an Over Current fault.**

DIMENSIONS

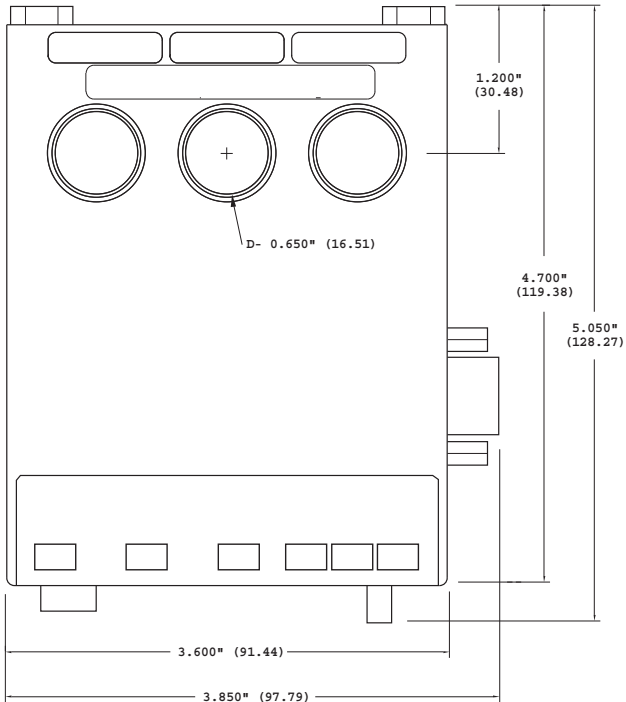
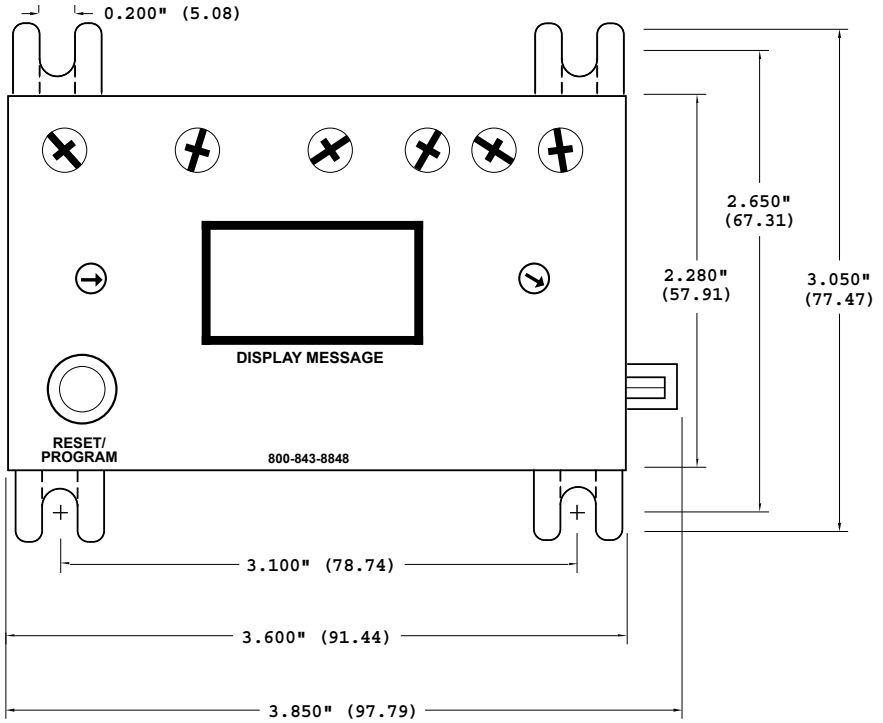

INDEX

Clear Last Fault	14
Communications Port	13
Connections	1
Dimensions	18
Fast Linear Trip Mode	5
Multi-Function System Display	11
Operation	2
Programmable Operating Points	17
Programming Examples	9
Programmable Parameters	5
Programming	4
Remote Reset	13
Specifications	15
Tamper Guard	14
Troubleshooting	12
Warranty	14

Visit our website at [Littelfuse.com/relays](https://www.littelfuse.com/relays)
for our complete catalog and new product
listings!