

FDA117

13.3V, 9.1 μ A Photovoltaic MOSFET Driver

Key Attributes

Characteristic	Rating (TYP)	Unit
Open Circuit Voltage ($I_F=5\text{mA}$)	13.3	V
Short Circuit Current ($I_F=5\text{mA}$)	9.1	μA
Input to Output Isolation	5	kV_{RMS}

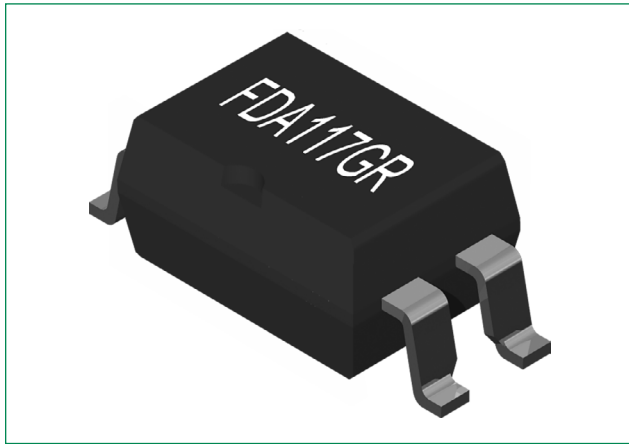

Features & Benefits

- Isolated Floating Output
- 5mA Control Circuitry
- Integrated Turn-Off Circuitry
- 5000V_{RMS} Isolation
- No EMI/RFI Generation
- Solid State Reliability
- Surface Mount, Tape & Reel Version Available

Applications

- MOSFET Driver
- Programmable Control
- Process Control
- Instrumentation
- Solid State Relay
- Isolated Switching
- Isolated Power Supply

Description



The FDA117 is a photovoltaic MOSFET driver comprising an LED that is optically coupled to a photodiode array.

The driver output is controlled by means of the efficient infrared LED at the input. When current is applied to the LED, its radiated light stimulates the photodiode array causing it to generate the voltage seen at the outputs.

The photodiode array is capable of generating a floating power source with sufficient voltage and current to drive high-power MOSFETs. An integrated turn-off circuit within the photodiode array discharges the external MOSFET's gate when the LED current is removed. This eliminates the need for external components to facilitate discharging the gate. The optically coupled technology provides 5000V_{RMS} of input to output isolation.

The FDA117 is well suited for use in discrete solid state relay designs and in other isolated switching applications.

Approvals

- EN62368-1: TUV Certificate # Pending
- UL Certified Component: File E76270
UL1577
CAN/CSA Component Acceptance
Service Notice No. 5A

Ordering Information

Part #	Description
FDA117G	4-Lead DIP (100/tube)
FDA117GRTR	4-Lead Surface Mount (1000/reel)

Pinout Diagram

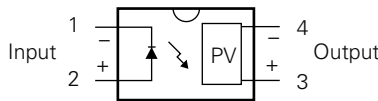

Absolute Maximum Ratings

Parameter	Rating	Unit
Reverse Input Voltage	5	V
Input Control Current	50	mA
Peak (10ms)	1	A
Input Power Dissipation ¹	140	mW
Total Power Dissipation	550	mW
ESD Rating, Human Body Model	4	kV
Isolation Voltage, Input to Output, 60s	5000	V _{RMS}
Operational Temperature, Ambient	-40 to +85	°C
Storage Temperature	-40 to +125	°C

¹ Derate linearly 1.33 mW / °C.

Absolute Maximum Ratings are stress ratings.

Stresses in excess of these ratings can cause permanent damage to the device. Functional operation of the device at conditions beyond those indicated in the operational sections of this data sheet is not implied. Absolute Maximum Ratings are at T_A=25°C.

Unless otherwise specified, device characteristics are at T_A=25°C.

Typical values are characteristic of the device at T_A=25°C and are the result of engineering evaluations. They are provided for informational purposes only and are not part of the manufacturing testing requirements.

Electrical Characteristics

Input Characteristics	Symbol	Conditions	Value			Unit
			Min	Typ	Max	
LED Current to Activate	I _F	I _{SC} =2.5μA	-	1.5	5	mA
		V _{OC} =5V	-	0.53	5	
Deactivation		V _{OC} =0.8V				
LED Current	I _F		0.05	0.48	-	mA
LED Voltage	V _F		0.8	1.24	-	V
Input Voltage Drop	V _F	I _F =5mA	1.25	1.36	1.5	V
		I _F =10mA	1.36	1.4	1.56	
Reverse Input Current	I _R	V _R =5V	-	-	10	μA

Output Characteristics	Symbol	Conditions	Value			Unit
			Min	Typ	Max	
Open Circuit Voltage	V _{OC}	I _F =5mA	10.5	13.34	15.3	V
		I _F =10mA	10.5	13.67	15.3	
Short Circuit Current	I _{SC}	I _F =5mA	2.5	9.1	-	μA
		I _F =10mA	5	19.15	-	
		I _F =15mA	7.5	29.33	-	
		I _F =20mA	10	39.53	-	
		I _F =30mA	15	59.67	-	
Off-state Output Discharge Resistance	R _{OUT}	V _L =0V	100	896	3300	Ω

Common Characteristics	Symbol	Conditions	Value			Unit
			Min	Typ	Max	
Capacitance, Input to Output	C _{IO}	f=1MHz	-	0.34	-	pF
Resistance, Input to Output	R _{IO}	500V _{DC}	500	-	-	MΩ
Isolation Voltage, Input to Output	V _{ISO}	f=50/60Hz, t=1s	6	-	-	kV _{RMS}

Timing Characteristics

Switching Speeds	Symbol	Conditions	Value			Unit
			Min	Typ	Max	
Turn-On	t_{ON}	$C_{LOAD}=200\text{pF}$, $V_{OUT}(\text{Rising})=5\text{V}$ $I_F=5\text{mA}$	-	0.162	1	ms
		$I_F=10\text{mA}$	-	0.075	-	
Turn-Off	t_{OFF}	$I_F=0\text{mA}$, $C_{LOAD}=200\text{pF}$, $V_{OUT}(\text{Falling})=0.5\text{V}$ from $I_F=5\text{mA}$	-	0.192	0.5	ms
		from $I_F=10\text{mA}$	-	0.201	-	

Characteristic Curves

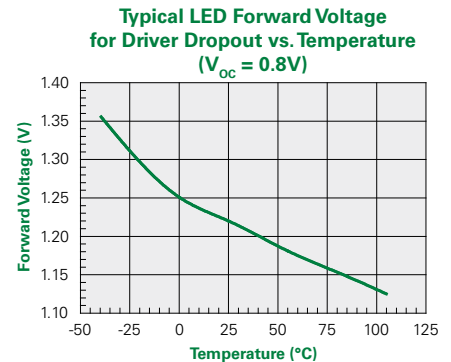
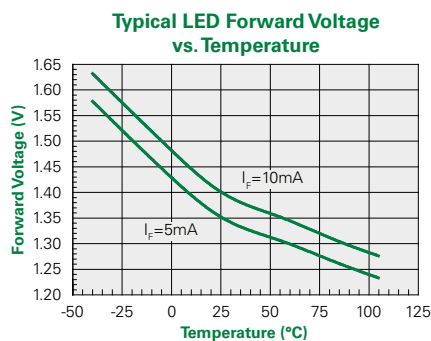
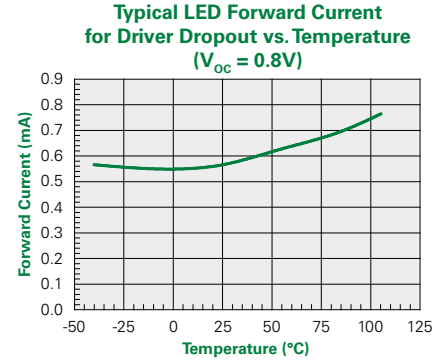
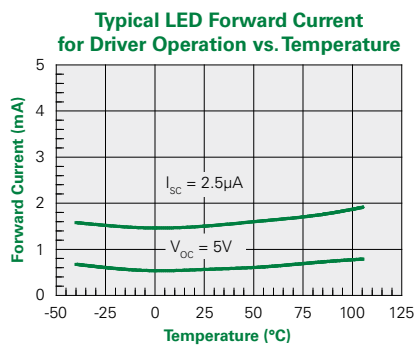
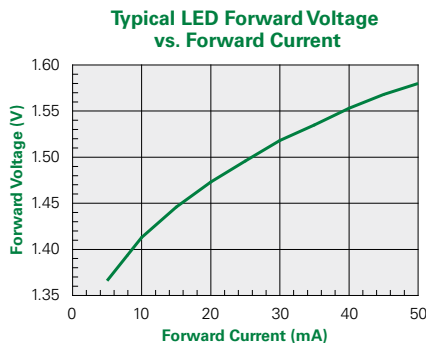
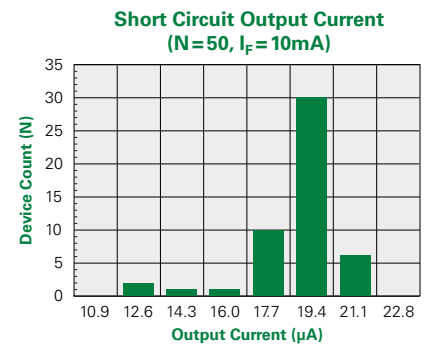
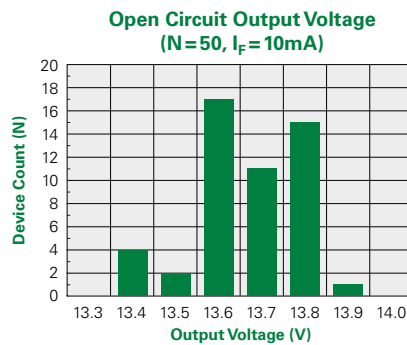
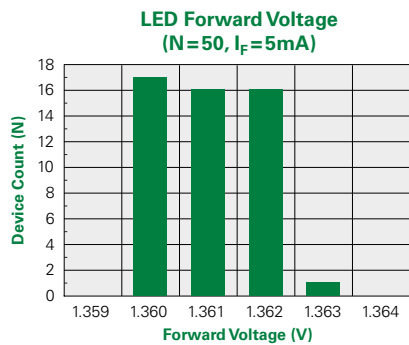

All temperatures are ambient and unless otherwise noted, the graph data is typical of the device at $T_A = 25^{\circ}\text{C}$. Device performance illustrated in the Characteristic Curves beyond the maximum ambient operational temperature of 85°C are for informational purposes only and do not constitute or imply approval to operate the device beyond the ratings stated in the specifications.

Characteristic Curves

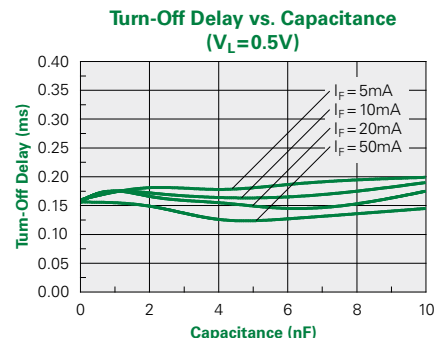
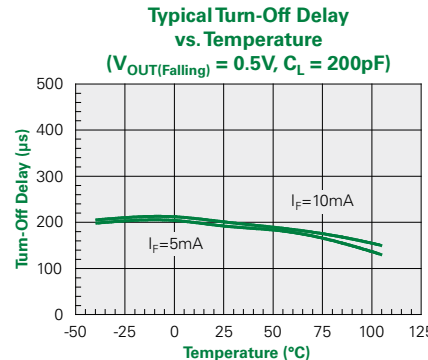
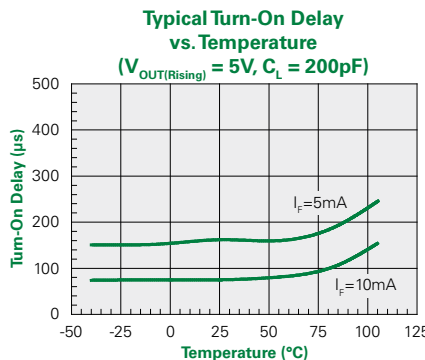
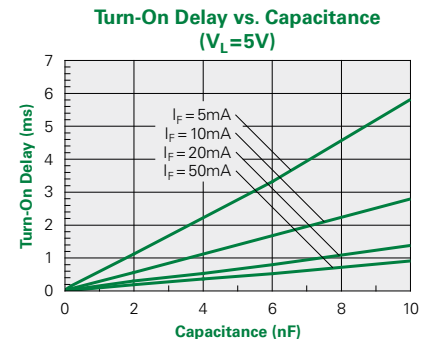
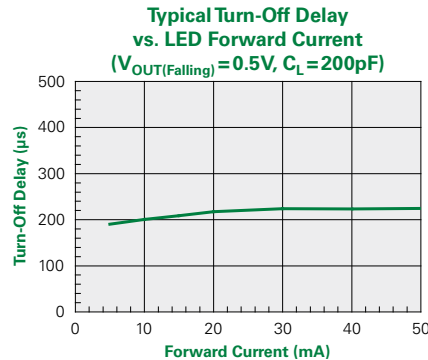
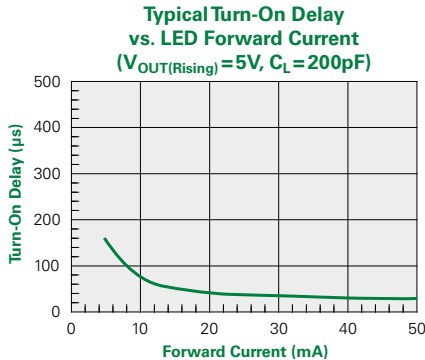
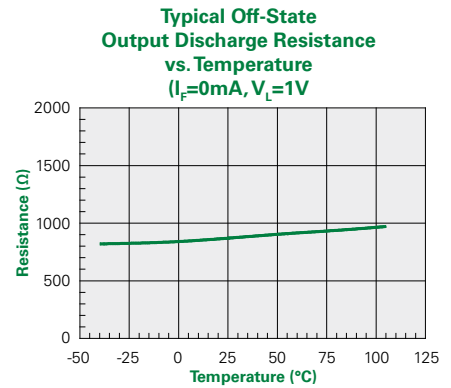
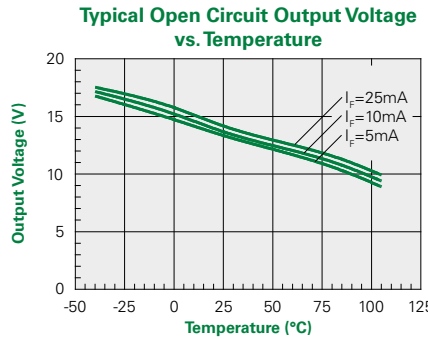
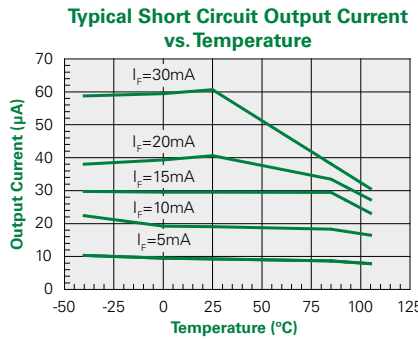
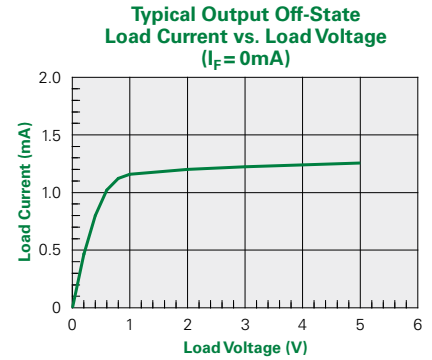
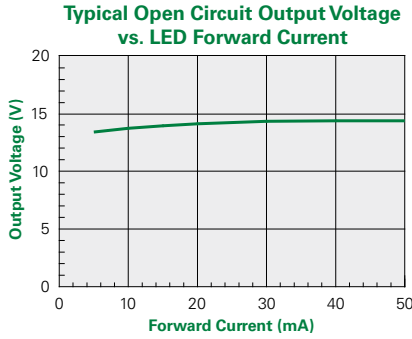
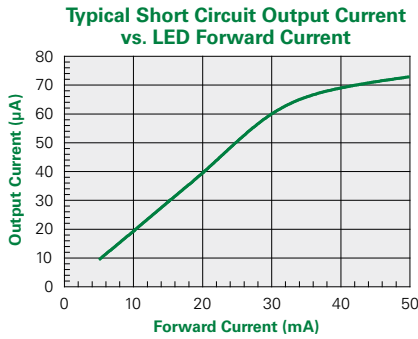

All temperatures are ambient and unless otherwise noted, the graph data is typical of the device at $T_A = 25^\circ\text{C}$. Device performance illustrated in the Characteristic Curves beyond the maximum ambient operational temperature of 85°C are for informational purposes only and do not constitute or imply approval to operate the device beyond the ratings stated in the specifications.

Manufacturing Information

Moisture Sensitivity



All plastic encapsulated semiconductor packages are susceptible to moisture ingress. Littelfuse Integrated Circuits classifies its plastic encapsulated devices for moisture sensitivity according to the latest version of the joint industry standard, **IPC/JEDEC J-STD-020**, in force at the time of product evaluation. We test all of our products to the maximum conditions set forth in the standard, and guarantee proper operation of our devices when handled according to the limitations and information in that standard as well as to any limitations set forth in the information or standards referenced below.

Failure to adhere to the warnings or limitations as established by the listed specifications could result in reduced product performance, reduction of operable life, and/or reduction of overall reliability.

This product carries a Moisture Sensitivity Level (MSL) classification as shown below, and should be handled according to the requirements of the latest version of the joint industry standard **IPC/JEDEC J-STD-033**.

Device	Moisture Sensitivity Level (MSL) Classification
FDA117GR	MSL 3

ESD Sensitivity



This product is ESD Sensitive, and should be handled according to the industry standard JESD-625.

Soldering Profiles

Provided in the table below is the **IPC/JEDEC J-STD-020** Classification Temperature (T_C) and the maximum total dwell time (t_p) in all reflow processes that the body temperature of these surface mount devices may be ($T_C - 5$)°C or greater. The device's body temperature must not exceed the Classification Temperature at any time during reflow soldering processes.

Device	Classification Temperature (T_C)	Dwell Time (t_p)	Max Reflow Cycles
FDA117GR	250°C	30 seconds	3

For through-hole devices, the maximum pin temperature and maximum dwell time through all solder waves is provided in the table below. Dwell time is the interval beginning when the pins are initially immersed into the solder wave until they exit the solder wave. For multiple waves, the dwell time is from entering the first wave until exiting the last wave. During this time, pin temperatures must not exceed the maximum temperature given in the table below. Body temperature of the device must not exceed the limit shown in the table below at any time during the soldering process.

Device	Maximum Pin Temperature	Maximum Body Temperature	Maximum Dwell Time	Wave Cycles
FDA117G	260°C	250°C	10 seconds*	1

*Total cumulative duration of all waves.

Board Wash

Littelfuse Integrated Circuits recommends the use of no-clean flux formulations. Board washing to reduce or remove flux residue following the solder reflow process is acceptable provided proper precautions are taken to prevent damage to the device. These precautions include but are not limited to using a low pressure wash and providing a follow up bake cycle sufficient to remove any moisture trapped within the device due to the washing process. Due to the variability of the wash parameters used to clean the board, determination of the bake temperature and duration necessary to remove the moisture trapped within the package is the responsibility of the user (assembler). Cleaning or drying methods that employ ultrasonic energy may damage the device and should not be used. Additionally, the device must not be exposed to halide flux or solvents.



Mechanical Dimensions

FDA117G

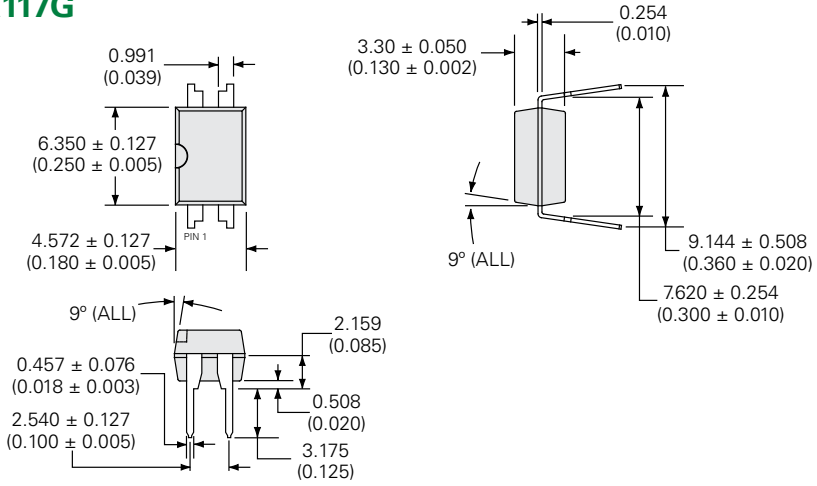

PC Board Pattern (Top View)

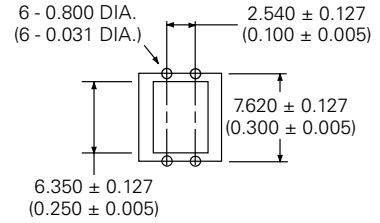

Dimensions
mm
(inches)

FDA117GR

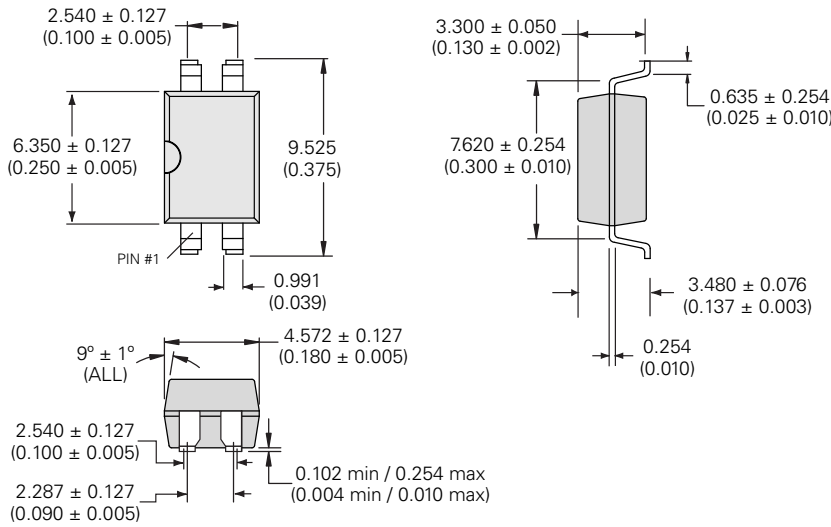

PCB Land Pattern

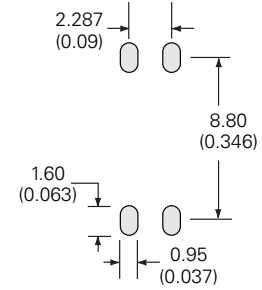

Dimensions
mm
(inches)

FDA117GRTR Tape & Reel

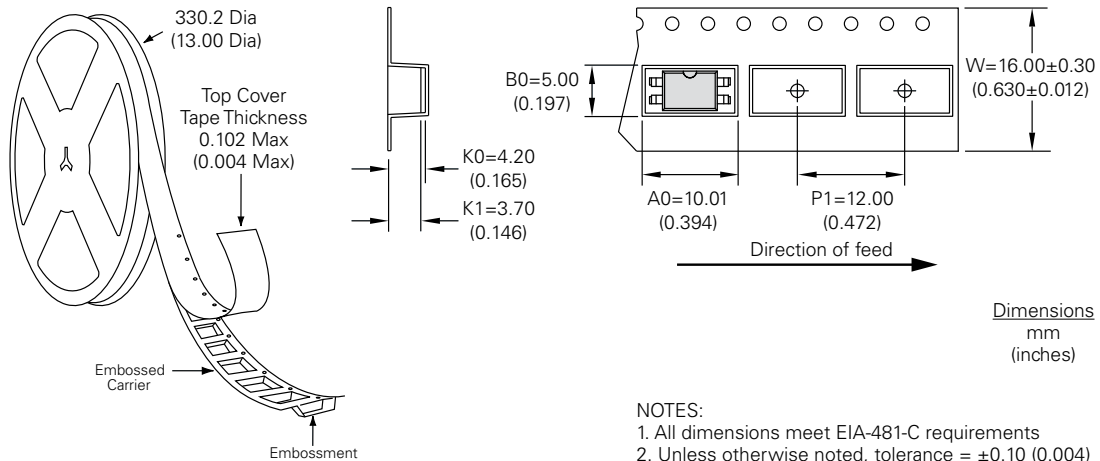

Dimensions
mm
(inches)

- NOTES:
 1. All dimensions meet EIA-481-C requirements
 2. Unless otherwise noted, tolerance = ± 0.10 (0.004)

Disclaimer Notice - Information furnished is believed to be accurate and reliable. However, users should independently evaluate the suitability of and test each product selected for their own applications. Littelfuse products are not designed for, and may not be used in, all applications. Read complete Disclaimer Notice at <http://www.littelfuse.com/disclaimer-electronics>