



Parameter	Rating	Units
Drain-to-Source Voltage - $V_{(BR)DSX}$	350	V
Max On-Resistance - $R_{DS(on)}$	14	$\Omega$
Max Power		
SOT-89 Package	1.1	W
SOT-223 Package	2.5	

### Features

- 350V Drain-to-Source Voltage
- Depletion Mode Device Offers Low  $R_{DS(on)}$  at Cold Temperatures
- Low On-Resistance:  $8\Omega$  (Typical) @  $25^{\circ}\text{C}$
- Low  $V_{GS(off)}$  Voltage
- High Input Impedance
- Low Input and Output Leakage
- Small Package Size SOT-89 and SOT-223
- PCB Space and Cost Savings

### Applications

- LED Drive Circuits
- Telecommunications
- Normally On Switches
- Ignition Modules
- Converters
- Security
- Power Supplies
- Regulators

### Circuit Symbol

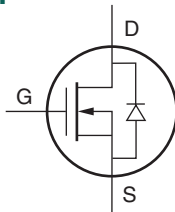

### Description

The CPC3708 is a N-channel, depletion mode Field Effect Transistor (FET) that is available in an SOT-223 package (CPC3708Z) and an SOT-89 package (CPC3708C). Both utilize IXYS Integrated Circuits Division's proprietary third-generation vertical DMOS process that realizes world class, high voltage MOSFET performance in an economical silicon gate process. The vertical DMOS process yields a highly reliable device, particularly for use in difficult application environments such as telecommunications, security, and power supplies.

CPC3708Z and the CPC3708C have a typical on-resistance of  $8\Omega$  and a drain-to-source voltage of 350V. As with all MOS devices, the FET structure prevents thermal runaway and thermally induced secondary breakdown.

### Ordering Information

Part Number	Description
CPC3708CTR	SOT-89: Tape and Reel (4000/Reel)
CPC3708ZTR	SOT-223: Tape and Reel (1000/Reel)

### Package Pinout:

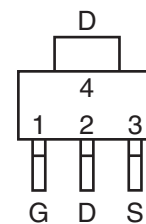

Pin Number	Name
1	GATE
2	DRAIN
3	SOURCE
4	DRAIN



### Absolute Maximum Ratings @ 25°C

Parameter	Ratings	Units
Drain-to-Source Voltage ( $V_{(BR)DSX}$ )	350	V
Gate-to-Source Voltage ( $V_{GS}$ )	±20	V
Total Package Dissipation <sup>1</sup>		
SOT-89	1.1	W
SOT-223	2.5	
Operational Temperature	-40 to +110	°C
Storage Temperature	-40 to +125	°C

<sup>1</sup> Mounted on 1"x1" FR4 board.

Absolute Maximum Ratings are stress ratings. Stresses in excess of these ratings can cause permanent damage to the device. Functional operation of the device at conditions beyond those indicated in the operational sections of this data sheet is not implied.

Typical values are characteristic of the device at +25°C, and are the result of engineering evaluations. They are provided for information purposes only, and are not part of the manufacturing testing requirements.

### Electrical Characteristics @25°C (Unless Otherwise Specified)

Parameter	Symbol	Conditions	Min	Typ	Max	Units
Gate-to-Source Voltage	$V_{GS}$	$I_D=60mA, V_{DS}=5V$	-1.005	-	-1.735	V
Gate-to-Source Off Voltage	$V_{GS(off)}$	$I_D=2\mu A, V_{DS}=10V, V_{DS}=100V$	-2	-	-3.6	V
Drain-to-Source Leakage Current	$I_{DS(off)}$	$V_{GS} = -5V, V_{DS}=190V$	-	-	20	nA
		$V_{GS} = -5V, V_{DS}=350V$	-	-	1	μA
Drain Current	$I_D$	$V_{GS} = -2.7V, V_{DS}=5V, V_{DS}=50V$	-	-	5	mA
		$V_{GS} = -0.57V, V_{DS}=5V$	130	-	-	mA
On-Resistance	$R_{DS(on)}$	$V_{GS} = -0.35V, I_{DS}=50mA$	-	8	14	Ω
Gate Leakage Current	$I_{GSS}$	$V_{GS}=\pm 20V$	-	-	100	nA
Gate Capacitance	$C_{ISS}$	$V_{DS} = V_{GS}=0V$	-	-	300	pF

### Thermal Impedance

Package	Parameter	Symbol	Conditions	Min	Typ	Max	Units
SOT-89	Junction to Case	$R_{\theta JC}$	-	-	-	50	°C/W
	Junction to Ambient	$R_{\theta JA}$				90	
SOT-223	Junction to Case	$R_{\theta JC}$	-	-	-	14	
	Junction to Ambient	$R_{\theta JA}$				55	

CPC3708Z (SOT-223) PERFORMANCE DATA \*

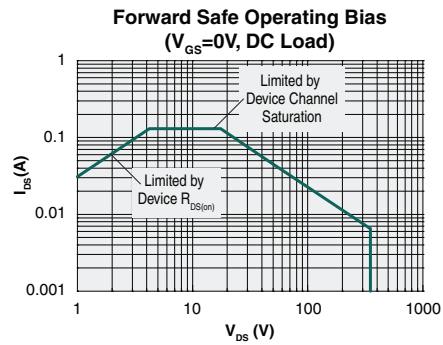
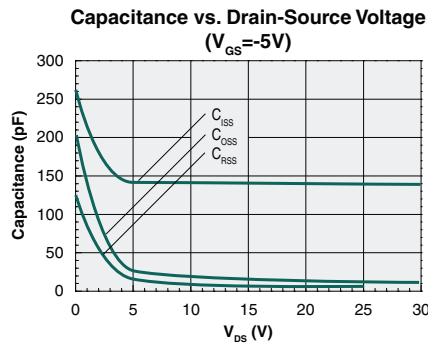
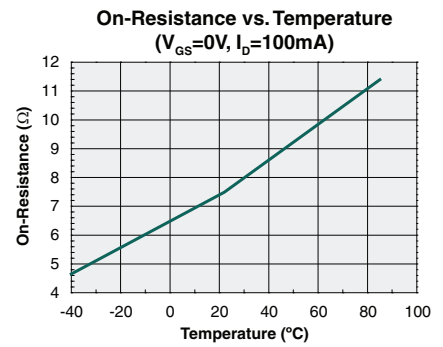
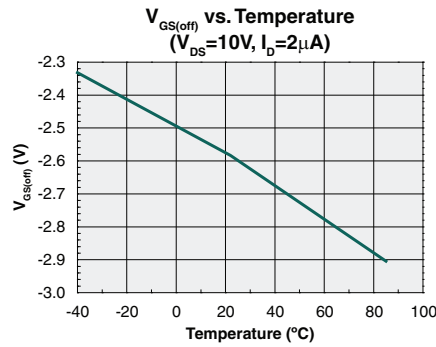
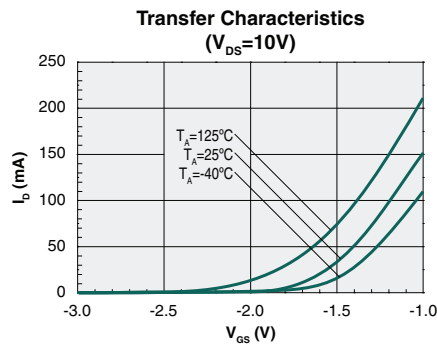
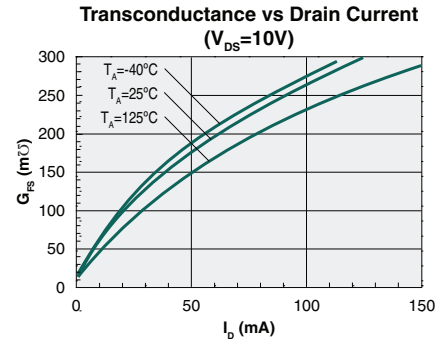
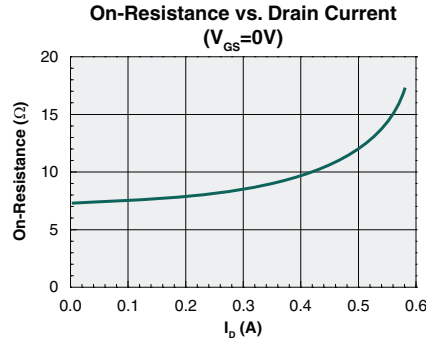
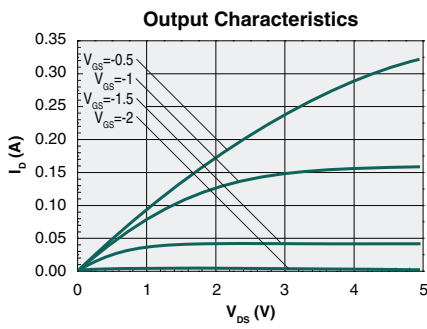

\*Unless otherwise noted, data presented in these graphs is typical of device operation at 25°C.

## Manufacturing Information

### Moisture Sensitivity



All plastic encapsulated semiconductor packages are susceptible to moisture ingress. IXYS Integrated Circuits classifies its plastic encapsulated devices for moisture sensitivity according to the latest version of the joint industry standard, **IPC/JEDEC J-STD-020**, in force at the time of product evaluation. We test all of our products to the maximum conditions set forth in the standard, and guarantee proper operation of our devices when handled according to the limitations and information in that standard as well as to any limitations set forth in the information or standards referenced below.

Failure to adhere to the warnings or limitations as established by the listed specifications could result in reduced product performance, reduction of operable life, and/or reduction of overall reliability.

This product carries a **Moisture Sensitivity Level (MSL)** classification as shown below, and should be handled according to the requirements of the latest version of the joint industry standard **IPC/JEDEC J-STD-033**.

Device	Moisture Sensitivity Level (MSL) Classification
CPC3708C / CPC3708Z	MSL 1

### ESD Sensitivity



This product is ESD Sensitive, and should be handled according to the industry standard **JESD-625**.

### Soldering Profile

Provided in the table below is the **IPC/JEDEC J-STD-020** Classification Temperature ( $T_C$ ) and the maximum dwell time the body temperature of these surface mount devices may be ( $T_C - 5$ )°C or greater. The Classification Temperature sets the Maximum Body Temperature allowed for these devices during reflow soldering processes.

Device	Classification Temperature ( $T_C$ )	Dwell Time ( $t_p$ )	Max Reflow Cycles
CPC3708C / CPC3708Z	260°C	30 seconds	3

### Board Wash

IXYS Integrated Circuits recommends the use of no-clean flux formulations. Board washing to reduce or remove flux residue following the solder reflow process is acceptable provided proper precautions are taken to prevent damage to the device. These precautions include but are not limited to: using a low pressure wash and providing a follow up bake cycle sufficient to remove any moisture trapped within the device due to the washing process. Due to the variability of the wash parameters used to clean the board, determination of the bake temperature and duration necessary to remove the moisture trapped within the package is the responsibility of the user (assembler). Cleaning or drying methods that employ ultrasonic energy may damage the device and should not be used. Additionally, the device must not be exposed to halide flux or solvents.



**MECHANICAL DIMENSIONS**

**CPC3708Z**

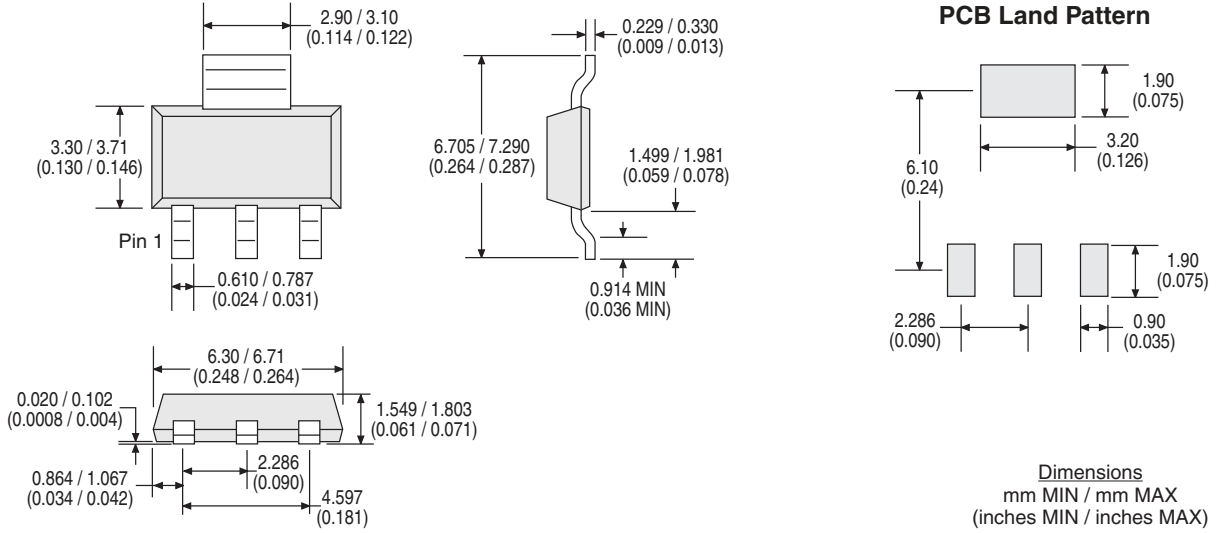

**CPC3708C**

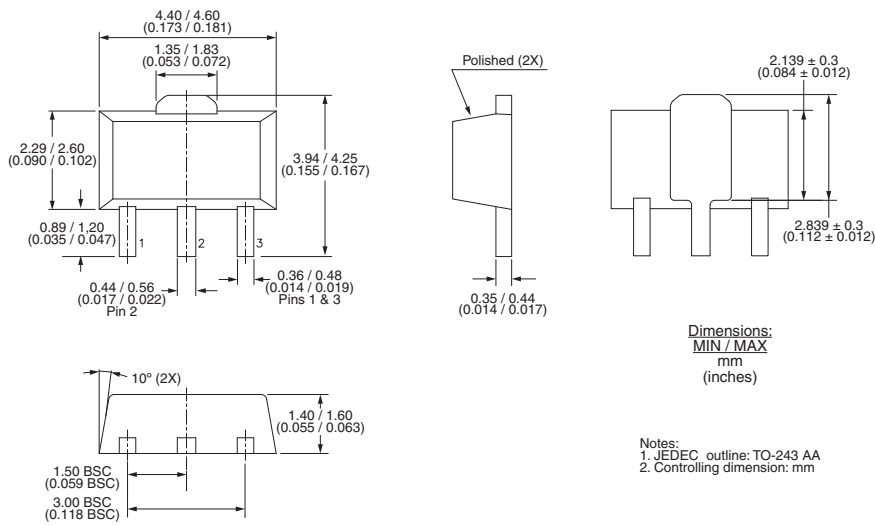

**MECHANICAL DIMENSIONS**

**CPC3708ZTR Tape & Reel**

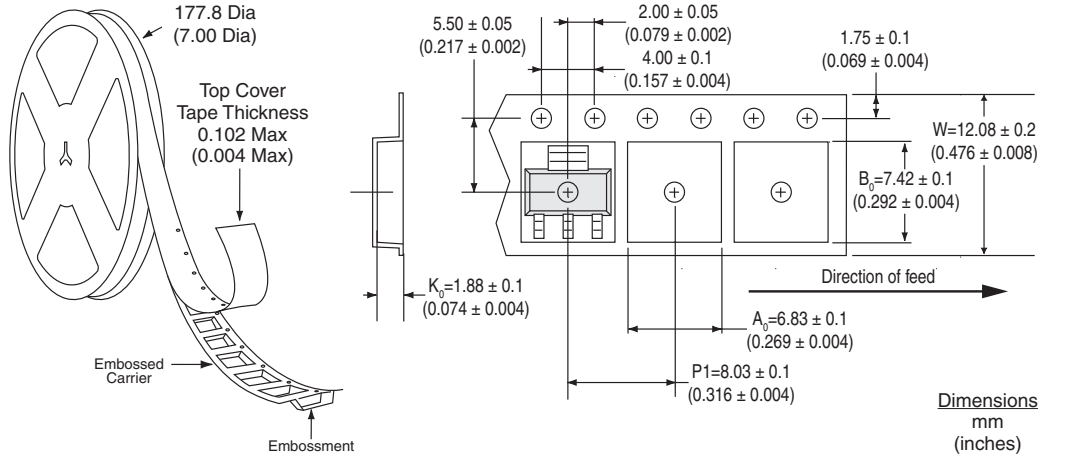

**CPC3708CTR Tape & Reel**

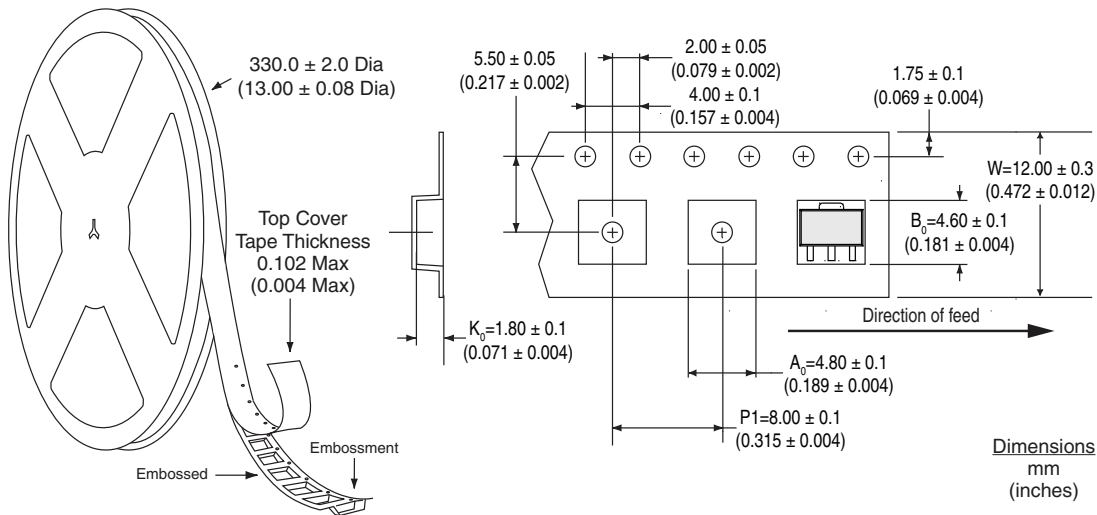

For additional information please visit our website at: <https://www.ixysic.com>