



Parameter	Rating	Units
Blocking Voltage	600	V_p
Load Current	90	mA_{rms} / mA_{DC}
On-Resistance (Max)		Ω
$I_L=120mA (t \leq 1s)$	35	
$I_L=90mA$	40	

Features

- $5000V_{rms}$ Input/Output Isolation
- $600V_p$ Blocking Voltage
- 100% Solid State
- Low Drive Power Requirements
- Arc-Free With No Snubbing Circuits
- No EMI/RFI Generation
- Small 4-Pin Package

Applications

- Meters (Watt-Hour, Water, Gas)
- Industrial Controls
- Instrumentation
- Data Acquisition
- Medical Equipment—Patient/Equipment Isolation
- Electronic Switching
- I/O Subsystems
- Multiplexers
- Security

Description

The CPC1394 is a single-pole, normally-open (1-Form-A) Solid State Relay with an enhanced input to output isolation barrier of $5000V_{rms}$.

The relay output is constructed with efficient MOSFET switches that use IXYS Integrated Circuits Division's patented OptoMOS architecture. The input, a highly efficient infrared LED, controls the optically coupled output.

Approvals

- UL Certified Component: File E76270
- EN/IEC 60950-1: Certificate # B 082667 0007

Ordering Information

Part Number	Description
CPC1394G	4-Pin DIP (100/Tube)
CPC1394GV	4-Pin DIP V-Bend (100/Tube)
CPC1394GR	4-Pin Surface Mount (100/Tube)
CPC1394GRTR	4-Pin Surface Mount (1000/Reel)

Pin Configuration

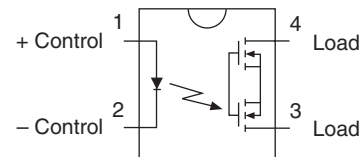

Switching Characteristics
of Normally Open Devices

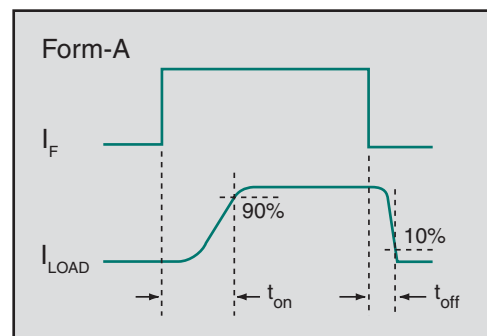

Absolute Maximum Ratings @ 25°C

Parameter	Ratings	Units
Peak Blocking Voltage	600	V _P
Reverse Input Voltage	5	V
Input Control Current	50	mA
Peak (10ms)	1	A
Input Power Dissipation ¹	100	mW
Total Package Dissipation ²	550	mW
Isolation Voltage, Input to Output	5000	V _{rms}
Operational Temperature	-40 to +85	°C
Storage Temperature	-40 to +125	°C

¹ Derate linearly 1.33mW / °C

² Derate output linearly 5.4mW / °C

Absolute Maximum Ratings are stress ratings. Stresses in excess of these ratings can cause permanent damage to the device. Functional operation of the device at conditions beyond those indicated in the operational sections of this data sheet is not implied.

Typical values are characteristic of the device at +25°C, and are the result of engineering evaluations. They are provided for information purposes only, and are not part of the manufacturing testing requirements.

Electrical Characteristics @ 25°C

Parameters	Conditions	Symbol	Min	Typ	Max	Units
Output Characteristics						
Load Current						
Continuous ¹	-	I _L	-	-	90	mA _{rms} / mA _{DC}
Peak	t=10ms	I _{LPK}	-	-	±600	mA _P
On-Resistance ²						
Continuous	I _L =90mA	R _{ON}		30	40	Ω
Pulse	I _L =120mA, t≤1s			26	35	
Off-State Leakage Current	V _L =600V _P	I _{LEAK}	-	-	1	μA
Switching Speeds						
Turn-On	I _F =5mA, V _I =10V (See Timing Diagram)	t _{on}	-	0.85	5	ms
Turn-Off		t _{off}	-	0.46	3	
Output Capacitance	I _F =0mA, V _L =50V, f=1MHz	C _{OUT}	-	50	-	pF
Input Characteristics						
Input Control Current to Activate ^{2,3}	I _L =120mA	I _F	-	0.45	2	mA
Input Control Current to Deactivate	-	I _F	0.2	0.4	-	
Input Voltage Drop	I _F =5mA	V _F	0.9	1.36	1.5	V
Reverse Input Current	V _R =5V	I _R	-	-	10	μA
Common Characteristics						
Input to Output Capacitance	V _{IO} =0V, f=1MHz	C _{IO}	-	3	-	pF

¹ Derate linearly 0.58mA / °C

² Measurement taken within 1 second of on-time.

³ For operation at temperatures >60°C, a minimum LED drive current of 4mA is recommended.

Timing Diagram

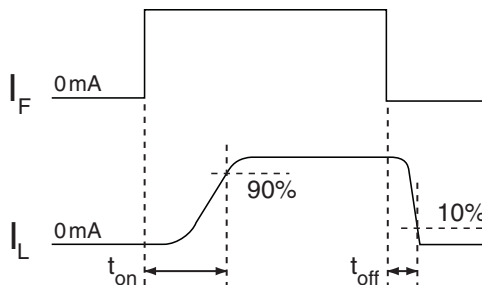

PERFORMANCE DATA @25°C (Unless Otherwise Noted)*

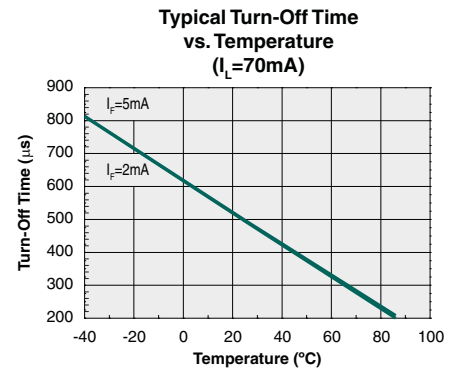
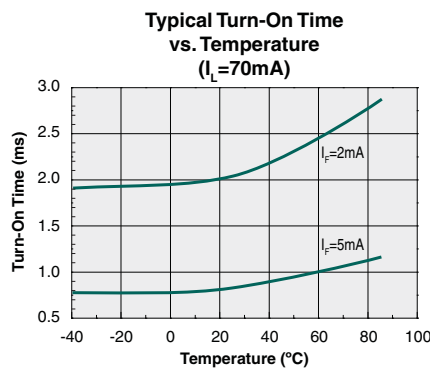
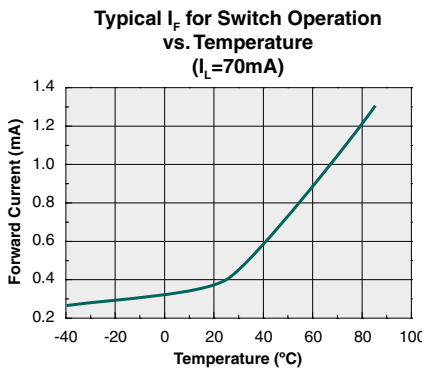
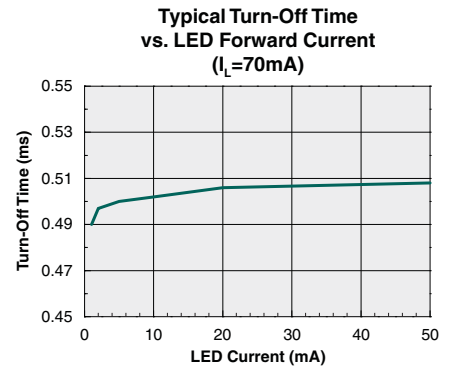
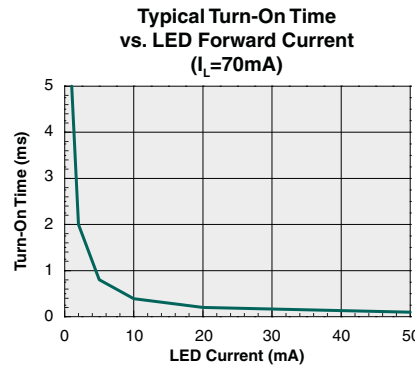
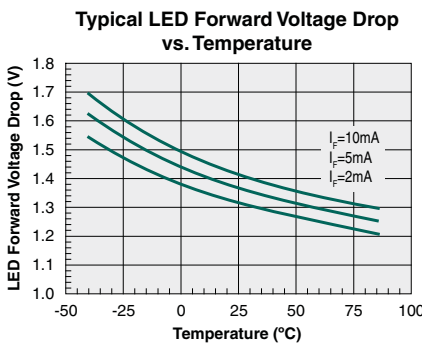
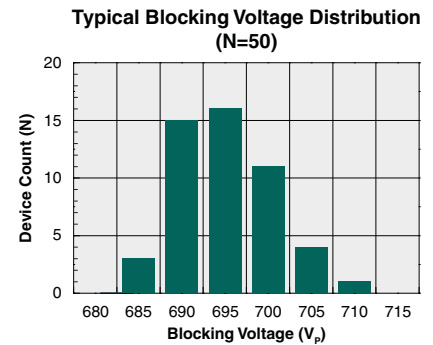
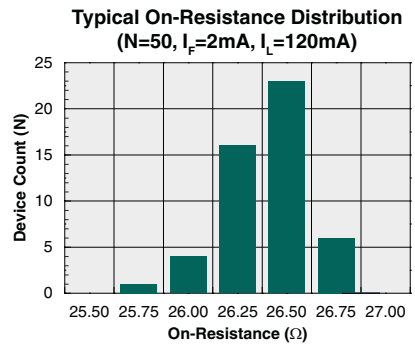
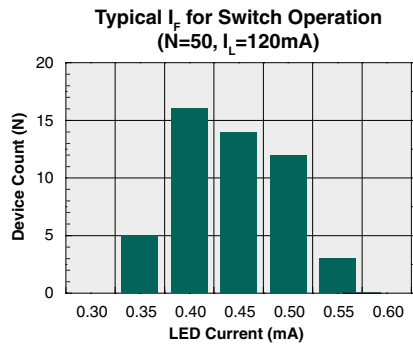
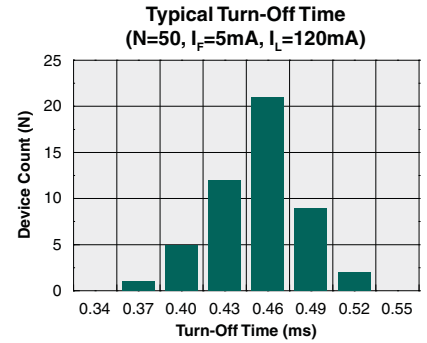
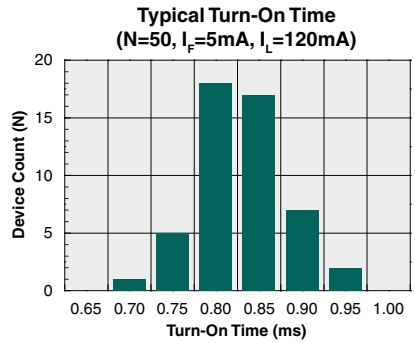
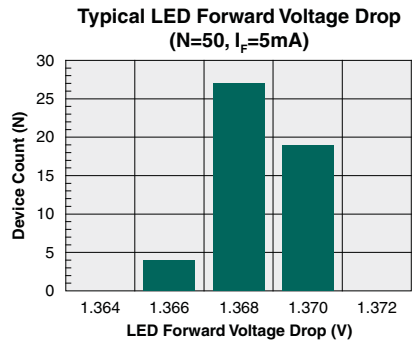

*Unless otherwise noted, data presented in these graphs is typical of device operation at 25°C. For guaranteed parameters not indicated in the written specifications, please contact our application department.

PERFORMANCE DATA @25°C (Unless Otherwise Noted)*

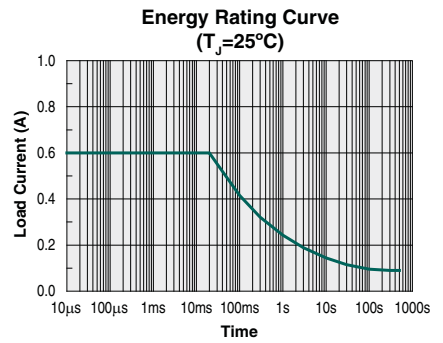
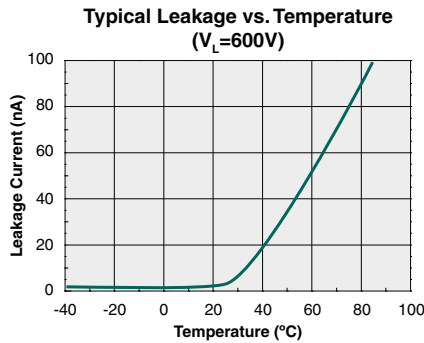
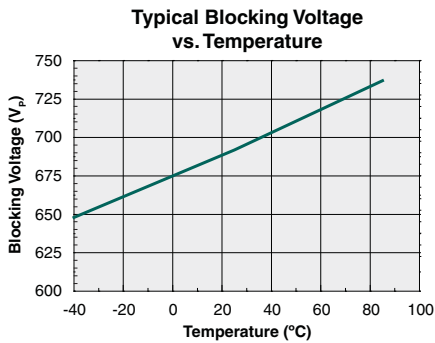
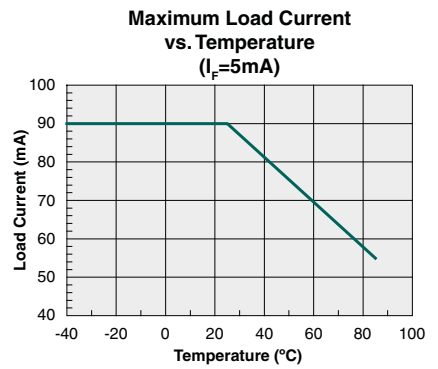
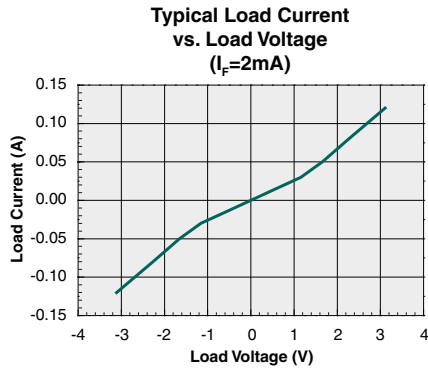
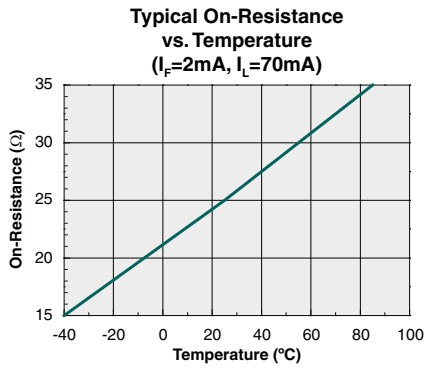

*Unless otherwise noted, data presented in these graphs is typical of device operation at 25°C. For guaranteed parameters not indicated in the written specifications, please contact our application department.

Manufacturing Information

Moisture Sensitivity



All plastic encapsulated semiconductor packages are susceptible to moisture ingress. IXYS Integrated Circuits classifies its plastic encapsulated devices for moisture sensitivity according to the latest version of the joint industry standard, **IPC/JEDEC J-STD-020**, in force at the time of product evaluation. We test all of our products to the maximum conditions set forth in the standard, and guarantee proper operation of our devices when handled according to the limitations and information in that standard as well as to any limitations set forth in the information or standards referenced below.

Failure to adhere to the warnings or limitations as established by the listed specifications could result in reduced product performance, reduction of operable life, and/or reduction of overall reliability.

This product carries a **Moisture Sensitivity Level (MSL)** classification as shown below, and should be handled according to the requirements of the latest version of the joint industry standard **IPC/JEDEC J-STD-033**.

Device	Moisture Sensitivity Level (MSL) Classification
CPC1394GR	MSL 3

ESD Sensitivity



This product is ESD Sensitive, and should be handled according to the industry standard **JESD-625**.

Soldering Profile

Provided in the table below is the **IPC/JEDEC J-STD-020** Classification Temperature (T_C) and the maximum dwell time the body temperature of these surface mount devices may be ($T_C - 5$)°C or greater. The Classification Temperature sets the Maximum Body Temperature allowed for these devices during reflow soldering processes.

Device	Classification Temperature (T_C)	Dwell Time (t_p)	Max Reflow Cycles
CPC1394GR	250°C	30 seconds	3

For through-hole devices, the wave soldering maximum lead (pin) temperature and the maximum dwell time the leads (pins) are at the peak soldering temperature is given in the table below. Maximum wave soldering parameters are shown below.

Device	Pin Temperature	Body Temperature	Dwell Time	Wave Cycles
CPC1394G / CPC1394GV	260°C	250°C	10 seconds	1

Board Wash

IXYS Integrated Circuits recommends the use of no-clean flux formulations. Board washing to reduce or remove flux residue following the solder reflow process is acceptable provided proper precautions are taken to prevent damage to the device. These precautions include but are not limited to: using a low pressure wash and providing a follow up bake cycle sufficient to remove any moisture trapped within the device due to the washing process. Due to the variability of the wash parameters used to clean the board, determination of the bake temperature and duration necessary to remove the moisture trapped within the package is the responsibility of the user (assembler). Cleaning or drying methods that employ ultrasonic energy may damage the device and should not be used. Additionally, the device must not be exposed to halide flux or solvents.



MECHANICAL DIMENSIONS

CPC1394G

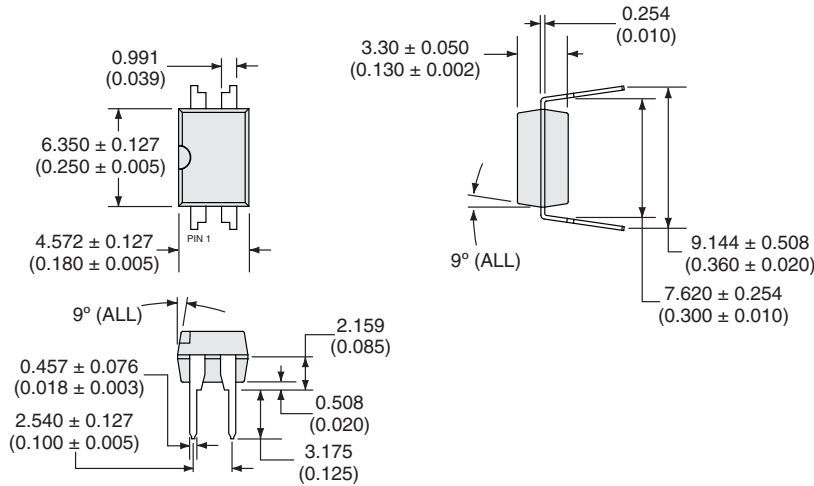

PC Board Pattern (Top View)

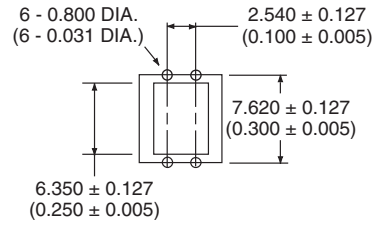

Dimensions
 mm
 (inches)

CPC1394GV

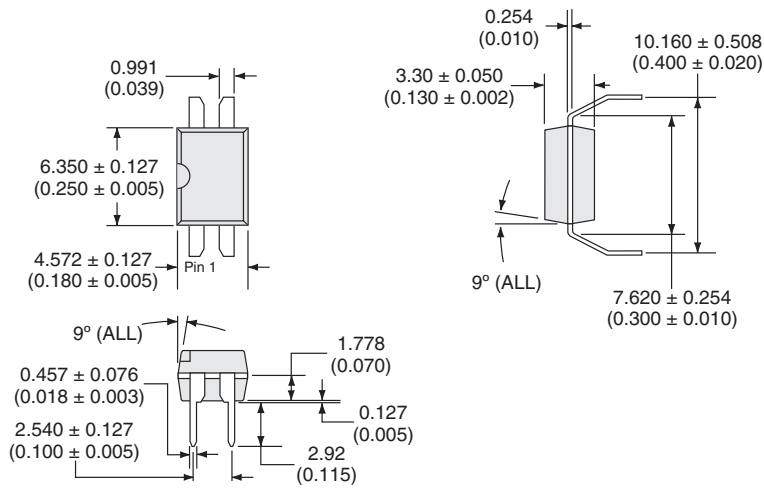

PC Board Pattern (Top View)

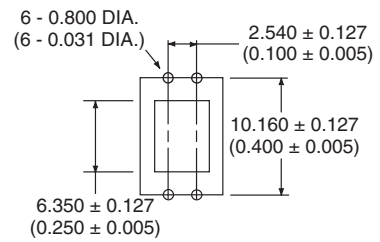

Dimensions
 mm
 (inches)

CPC1394GR

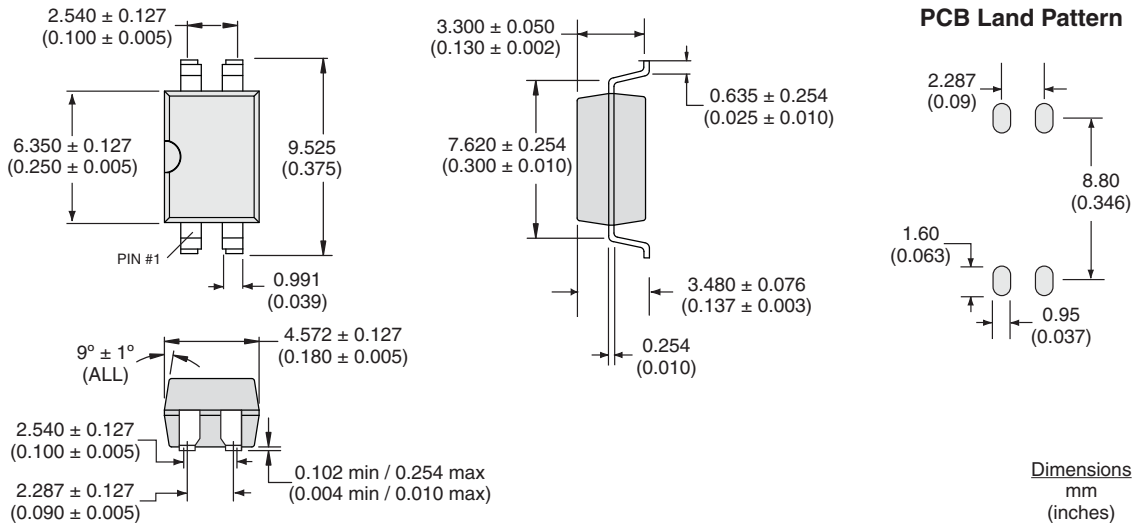

CPC1394GRTR Tape & Reel

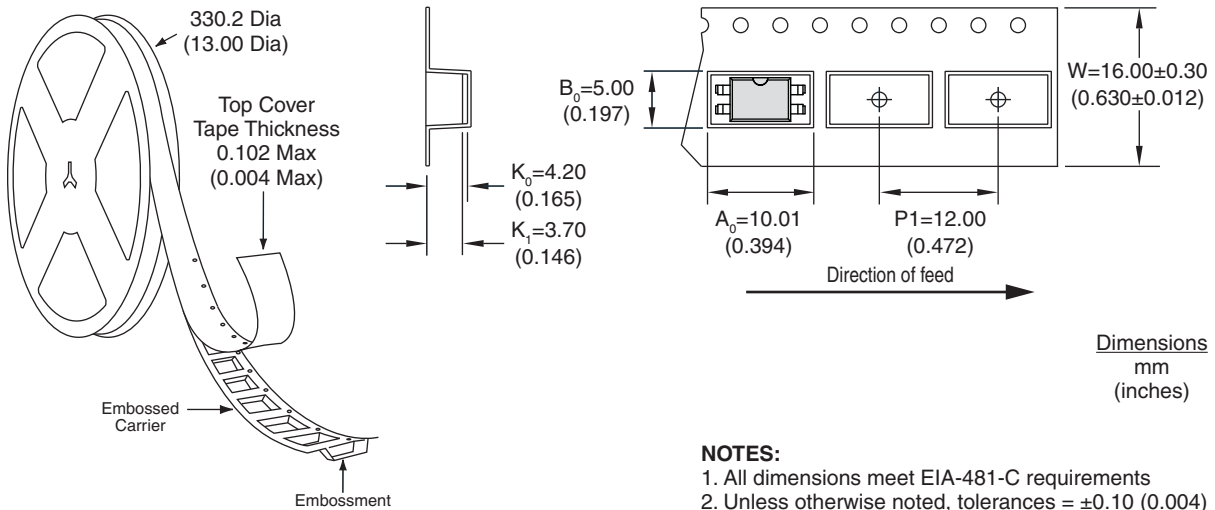

For additional information please visit our website at: www.ixysic.com