

AF0100 ARC-FLASH RELAY Instruction Manual

REVISION 0-B-013118

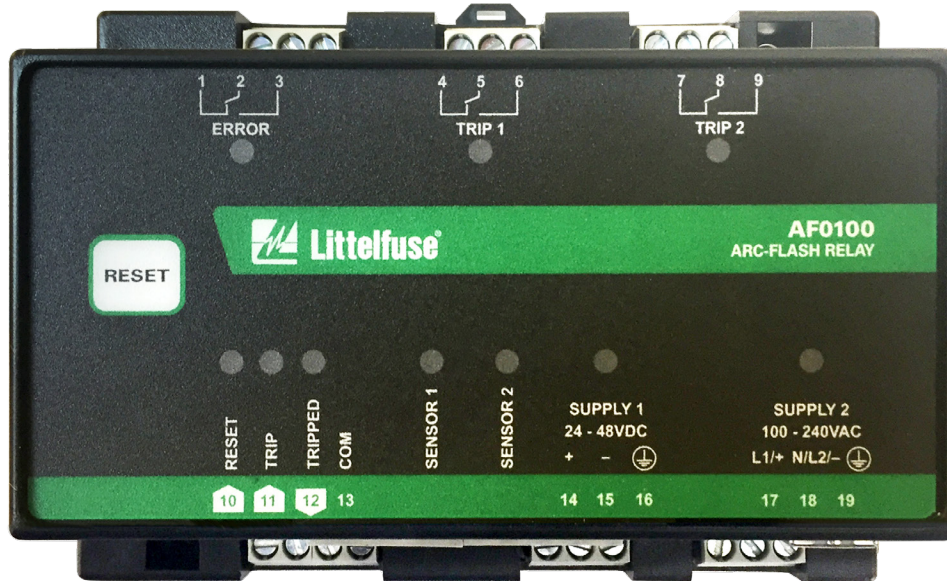

Copyright © 2018 Littelfuse
All rights reserved.

This page intentionally left blank.

TABLE OF CONTENTS

1 KEY FEATURES	1	7 USER INTERFACE	18
1.1 <i>Easy Installation</i>	1	7.1 <i>Reset Button</i>	18
1.2 <i>Fail-Safe Operation</i>	1	7.2 <i>LED Indication and</i>	
1.3 <i>Fast Error and Fault Location</i>	1	<i>Relay Operation</i>	18
1.4 <i>USB Interface</i>	1	7.3 <i>USB Configuration Software</i>	20
2 ARC-FLASH PROTECTION SYSTEM DESIGN	3	7.3.1 <i>USB Configuration Software –</i>	
3 SENSOR PLACEMENT	5	<i>Screen Examples</i>	21
3.1 <i>General Guidelines</i>	5	7.4 <i>Firmware Upgrade</i>	24
3.2 <i>Switchgear Protection</i>	5	8 COMMISSIONING	25
3.3 <i>Transformer Protection</i>	5	8.1 <i>Configuration of Installed Sensors</i>	25
3.4 <i>Generator Protection</i>	5	8.2 <i>Testing the Sensors</i>	25
4 OPTICAL SENSORS	6	8.3 <i>Testing the TRIP 1 and TRIP 2 Outputs</i>	
4.1 <i>PGA-LS10 Photoelectric Point Sensor</i>		<i>and Associated Circuit Breakers</i>	26
<i>with Sensor Check</i>	7	8.4 <i>Full Operation Test</i>	26
4.1.1 <i>PGA-LS10 Connection</i>	8	9 SUPPORT RESOURCES	27
4.1.2 <i>PGA-LS10 Installation</i>	9	9.1 <i>Sending Information for Support</i>	27
4.2 <i>PGA-LS20 and PGA-LS30</i>		10 SPECIFICATIONS	28
<i>Fiber-Optic Sensors with</i>		10.1 <i>AF0100</i>	28
<i>Sensor Check</i>	10	10.2 <i>EMC Tests</i>	29
4.2.1 <i>Fiber Connection</i>	10	10.3 <i>Environmental Tests</i>	29
4.2.2 <i>Receiver Wiring Connections</i>	10	10.4 <i>Safety</i>	30
4.2.3 <i>Transmitter Wiring Connections</i>	10	10.5 <i>Certification</i>	30
4.2.4 <i>PGA-LS20 and PGA-LS30 Connection</i>	11	10.6 <i>Sensors</i>	31
4.2.5 <i>Fiber-Optic Sensor Adjustment</i>	12	10.7 <i>Ordering Information</i>	32
4.2.6 <i>Sensor Adjustment For a Fiber Length</i>		10.8 <i>Related Products</i>	32
<i>Other Than 60 cm (24 in)</i>	12	10.9 <i>Warranty</i>	32
5 APPLICATION EXAMPLES	13		
5.1 <i>Basic Scenario: One Sensor –</i>			
<i>One Circuit Breaker</i>	13		
5.2 <i>Total Clearing Time</i>	14		
5.2.1 <i>Arc-Detection Delay</i>	14		
5.2.2 <i>Circuit Breaker Operating Time</i>	14		
5.2.3 <i>Total Clearing Time Examples</i>	14		
6 INSTALLATION AND TERMINALS	15		
6.1 <i>Power Supply</i>	16		
6.1.1 <i>Line AC Supply (optional)</i>	16		
6.1.2 <i>Station Battery DC Supply (optional)</i> ..	16		
6.1.3 <i>Auxiliary DC Supply</i>	16		
6.1.4 <i>Supply Surveillance</i>	16		
6.2 <i>Inputs and Outputs</i>	17		
6.2.1 <i>ERROR Signal Relay</i>	17		
6.3 <i>Sensors</i>	17		
6.3.1 <i>Light Immunity Adjustment</i>	17		
6.3.2 <i>Extending or Shortening Cable Length</i>	17		

APPENDIX A: INSTALLATION LOG SHEET	34
APPENDIX B: REDUNDANT TRIP CIRCUIT DESCRIPTION	35
APPENDIX C: AF0100 REVISION HISTORY	36

LIST OF FIGURES

1	<i>AF0100 Top View (ordering option AF0100-00 shown).....</i>	2
2	<i>AF0100 with Sensor and USB View (ordering option AF0100-00 shown).....</i>	2
3	<i>AF0100 Typical Wiring Diagram.....</i>	4
4	<i>PGA-LS10 Detection Range for a 3 kA Fault.....</i>	7
5	<i>PGA-LS10 Connection Diagram.....</i>	8
6	<i>PGA-LS10 Mounting Detail</i>	9
7	<i>PGA-LS20 and PGA-LS30 Connection Diagram.....</i>	11
8	<i>Basic AF0100 Configuration</i>	13
9	<i>AF0100 Outline And Mounting Details.....</i>	15
10	<i>TRIP and ERROR Relays Maximum Switching Capacity.....</i>	33

LIST OF TABLES

1	<i>Circuit Breaker Operating Time.....</i>	14
2	<i>AF0100 Firmware Upgrade Sequence</i>	24
3	<i>Sample Table for Testing a System.....</i>	26

1 KEY FEATURES

The AF0100 Arc-Flash Relay is a high-speed, arc-detection device for electrical power-distribution systems. The AF0100 has two Form-C Trip relays, and has inputs for up to two optical sensors for optimal arc detection. The inputs support both point sensors and fiber-optic line sensors, which cover a larger area.

Using optical sensors rather than relying strictly on current measurement allows a much faster detection time than overcurrent relays or a circuit breaker alone can typically provide, as the light from the arc is unique to arc faults, whereas current pulses above the nominal level are part of normal operation for many systems.

On the occurrence of an arc fault, the AF0100 detects the fault and activates the trip relays, which trips the circuit breaker(s) supplying the fault. In a typical system, a trip occurs within 5ms. The total arcing time is effectively reduced to the mechanical opening time of the circuit breaker, typically between 30 and 75 milliseconds. This reduces the energy of the arc fault significantly, increasing worker safety, reducing fault damage, and improving uptime.

The AF0100 can be used on ac or dc electrical systems and can be powered from either an ac or dc supply, or both. For all available ordering options, see section 10.7.

1.1 Easy Installation

The AF0100 includes two sensor inputs, two trip relays, one error relay, and a digital input and output interface which makes it possible to connect additional AF0100 or AF0500 units. See Fig. 1. The complete configuration and “programming” of the system can be done by simply wiring the inputs and outputs marked with green arrows – no external software is needed.

A system with multiple zones and upstream circuit breakers can be implemented such that in many applications, the switchboard wiring diagram can completely describe how the arc-flash system works.

The relay will automatically learn which sensors and power supplies are connected, and will indicate an alarm if a previously connected wire breaks or is unplugged. If a configuration change is needed, the redetection process can be triggered by pressing the Reset button for 20 s, see section 7.1.

1.2 Fail-Safe Operation

The AF0100 continuously monitors its internal circuitry as well as the connected optical sensors. Any system faults, including a sensor-cable fault, are indicated by an Error relay and the Error LED on the front panel.

A redundant trip circuit ensures that the AF0100 will trip the circuit breaker on an arc flash even if a primary trip-circuit component fails (shunt trip mode only). The design of the redundant trip circuit also provides a significantly faster response to an arc on power-up (for example, after maintenance during a shutdown) than is possible with microprocessor-only relays, which is an advantage in smaller self-powered systems.

1.3 Fast Error and Fault Location

The optical sensors used with the AF0100 have built-in LED's for indication of health and for easy location of arc faults. The AF0100 also has one LED per optical sensor on the front panel to indicate which sensor(s) have caused a trip and for indicating problems in the installation.

1.4 USB Interface

A USB interface on the lower panel of the AF0100 provides easy PC access to configuration settings. No PC driver or software installation is required.

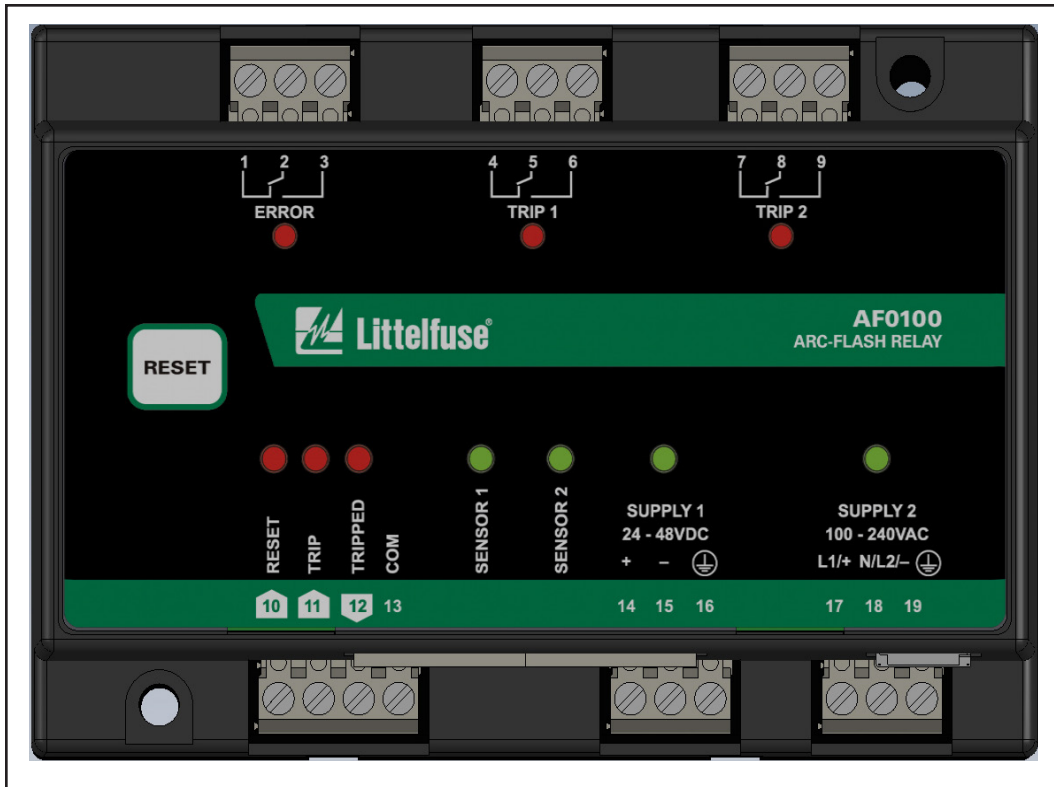

FIGURE 1. AF0100 Top View (ordering option AF0100-00 shown).

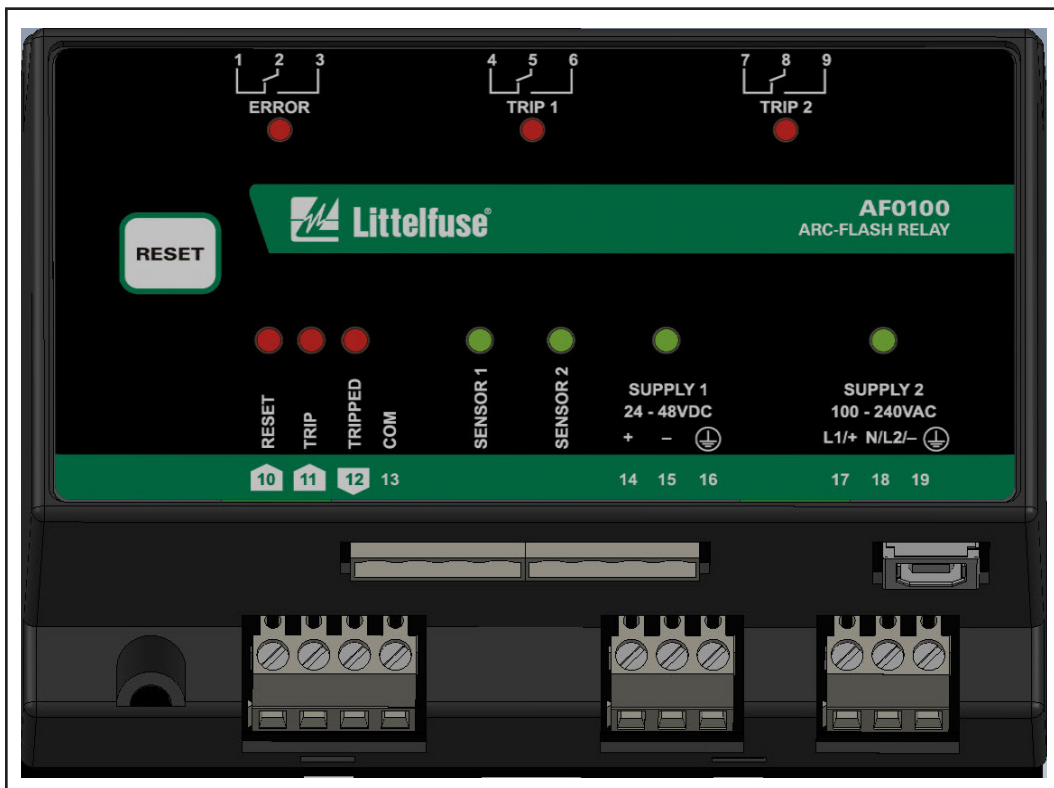

FIGURE 2. AF0100 with Sensor and USB View (ordering option AF0100-00 shown).

2 ARC-FLASH PROTECTION SYSTEM DESIGN

In order to find the necessary components and configuration for protecting a system, a single line diagram and knowledge of the physical configuration of the system is needed.

1. Start by identifying the number and type of sensors that are needed to have coverage of the complete system. In order to have complete coverage, all bus bar sections, circuit breaker connection points, and bolted connections must have a sensor nearby. Typically, a single point sensor per enclosed switchgear compartment is sufficient, but if a large internal component is blocking the line-of-sight, an additional sensor may be necessary. A fiber sensor can be threaded along a bus bar to protect many compartments, but only if they are interrupted by the same circuit breaker. The fiber sensor can also be used to improve coverage of compartments with many bulky components.
2. Identify which circuit breakers to open in order to completely interrupt all current to each sensor. If more sensors are isolated by the same set of circuit breakers, these are said to be in the same zone – an arc-flash event on any of these sensors will open the same set of circuit breakers.
3. Identify if the system needs coordinated tripping – if upstream circuit breakers, which trips the incoming feeder for several downstream circuit breakers, are present in the system, a decision must be made to either merge all the smaller zones and trip all circuit breakers at once (fast and inexpensive, but may trip more outgoing feeders than necessary), or to only trip the upstream circuit breaker if the downstream circuit breaker fails to interrupt the current (slower and costlier, but trips only what is necessary).
4. Based on the number of sensors and zones, the necessary number of outputs and sensors can be found. Each AF0100 provides one zone (one or two circuit breaker outputs) and two sensor inputs, which can be bundled into larger zones by a single wire, and which can combine fiber and point sensors completely as needed.
5. Now, place one AF0100 trip output for each circuit breaker in the system. If there are more than two sensors per zone, connect additional AF0100 or AF0500 zones together by connecting the “TRIP” and “TRIPPED” terminals in all zones. Zones can also be made larger by using a sensor covering a larger area, i.e. by changing point sensors to fiber sensors. Place the sensors in the cabinets, and connect them to the zone inputs. The sensor cables, which use copper wire, can be shortened or extended as needed.

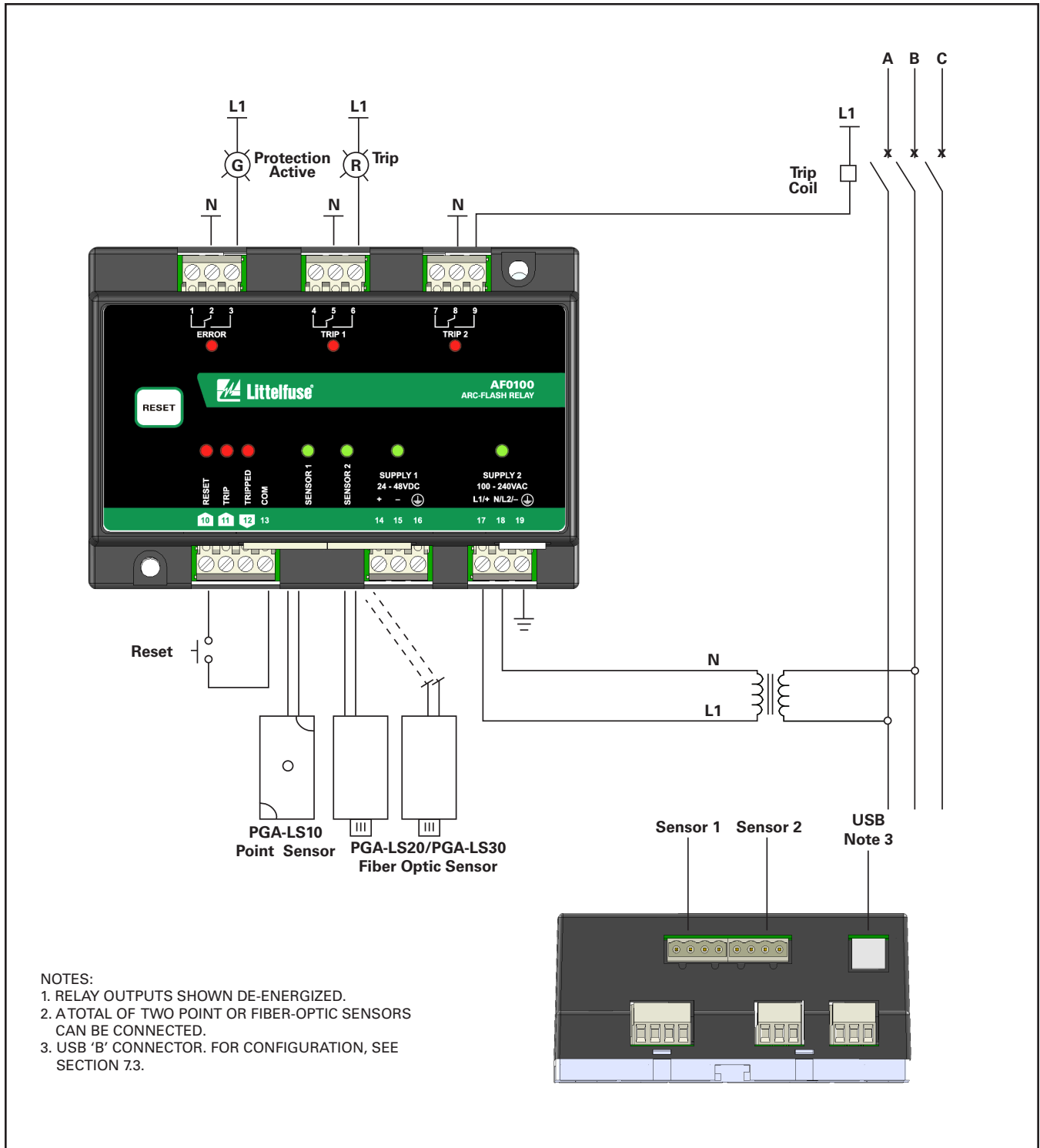

FIGURE 3. AF0100 Typical Wiring Diagram.

3 SENSOR PLACEMENT

3.1 General Guidelines

Optical sensors should have line-of-sight to points being monitored. Ensure that the point sensors and fiber are not blocked by fixed or moveable objects. Areas that will be accessed for maintenance or with moveable parts (such as draw-out circuit breakers) should be considered a high priority for installation. Do not place sensors or cables on bare components that will be energized and avoid sharp bends in the cable, particularly when using the PGA-LS20 and PGA-LS30 fiber-optic sensors. The electrical cables and sensors should be considered to be at ground potential when determining electrical clearances.

Sensors should be mounted in a location that will minimize the chance of debris or dust build-up and with easy access for maintenance if needed. A point sensor mounted at the top of an enclosure and facing down is optimal for reducing dust build-up. It should be noted that most enclosures are metallic and the reflectivity combined with the high intensity of an arc mean that even a moderately dusty sensor will collect adequate light.

In dusty environments, sensor cleaning should be part of a regular maintenance schedule and can be performed using compressed air or a dry cloth.

3.2 Switchgear Protection

The sensors used for arc-flash detection are optical sensors. Line-of-sight between the points where an arc could occur and the sensor is optimal, but the reflectivity of metallic compartments will help in distributing the light from an arc fault in the entire cabinet.

Often one point sensor is sufficient to monitor a complete switchgear compartment. However, if there are large components such as circuit breakers that cast shadows over wider areas, more than one point sensor is required.

3.3 Transformer Protection

The AF0100 can also be used for the protection of transformers. Two or more point sensors should be used per transformer to monitor the primary and secondary connection terminals. For the placement of the sensors, the same considerations apply as for switchgear protection.

3.4 Generator Protection

The main area of concern for protecting the generator is the conductors between the generator and the generator breaker. A fault in this area is not protected by the generator breaker from overcurrent or arc flash. Often, one or two sensors are enough to monitor the breaker and bus connection back to the generator. If other electrical equipment is installed on the generator, it should also be considered in an arc-flash risk assessment. When protecting the generator to a breaker connection, it is important to disconnect all sources of energy for the arc flash. Open the generator breaker to disconnect from the utility or other parallel generators, and connect to the automatic voltage regulator (AVR), emergency stop or other control circuit to turn off the generator. The two trip relays on the AF0100 are isolated so that the breaker and control circuit can both be tripped using independent voltages if necessary.

4 OPTICAL SENSORS

The AF0100 has two inputs for optical arc-fault sensors.

Two sensor types are supported:

- PGA-LS10 Photoelectric Point Sensors with sensor check
- PGA-LS20 and PGA-LS30 Fiber-Optic Sensors with sensor check

The sensors can be used together, in any combination.

Both sensor types have LED indication of sensor health and fault location. A sensor-check circuit tests the sensor to verify that the sensor assembly is functioning correctly. A healthy sensor will flash its internal red LED every few seconds. A sensor that has detected an arc will indicate solid red until the trip is reset.

The sensors connect to the AF0100 with shielded three-wire 20 AWG (0.5 mm²) electrical cable. Each sensor includes 10 m (33 ft) of cable which can be shortened or extended up to 50 m (164 ft). These cables should be considered to be at ground potential when determining electrical clearances in the cabinet.

Any connected optical sensor with circuit check will be automatically detected and cause the AF0100 to report an error if it is subsequently disconnected.

NOTE: Inserting and removing a sensor cable can cause a trip, depending on which terminals make contact first. To guard against nuisance tripping, remove the trip coil terminal blocks before connecting and disconnecting sensors, or perform the maintenance while the system is de-energized.

PGA-LS10



PGA-LS20 / PGA-LS30



4.1 PGA-LS10 Photoelectric Point Sensor with Sensor Check

This sensor has a detection area of a 2-m (7-ft) half-sphere for arcs of 3 kA or more.

A built-in LED enables the AF0100 to verify the function of the light sensor, wiring, and electronics. If the sensor does not detect the sensor-check LED, a sensor-fail alarm will

occur – the ERROR relay will change state and the sensor indication LED will begin to flash. See Section 7.

The sensor includes 10 m (33 ft) of shielded three-wire electrical cable which can easily be shortened or extended to a maximum of 50 m (164 ft). For more information on sensor cabling, see Section 6.3.2.

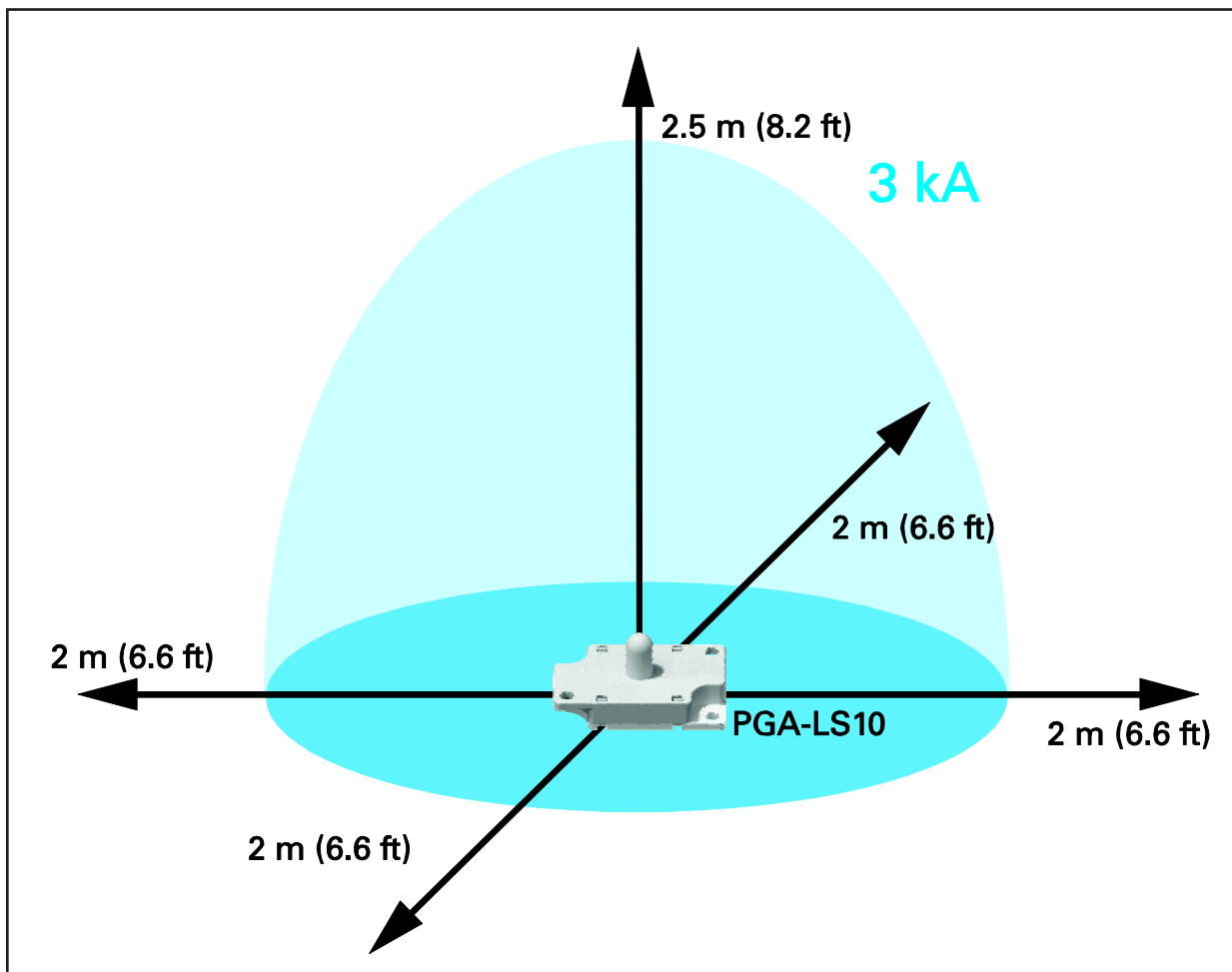

FIGURE 4. PGA-LS10 Detection Range for a 3 kA Fault.

4.1.1 PGA-LS10 Connection

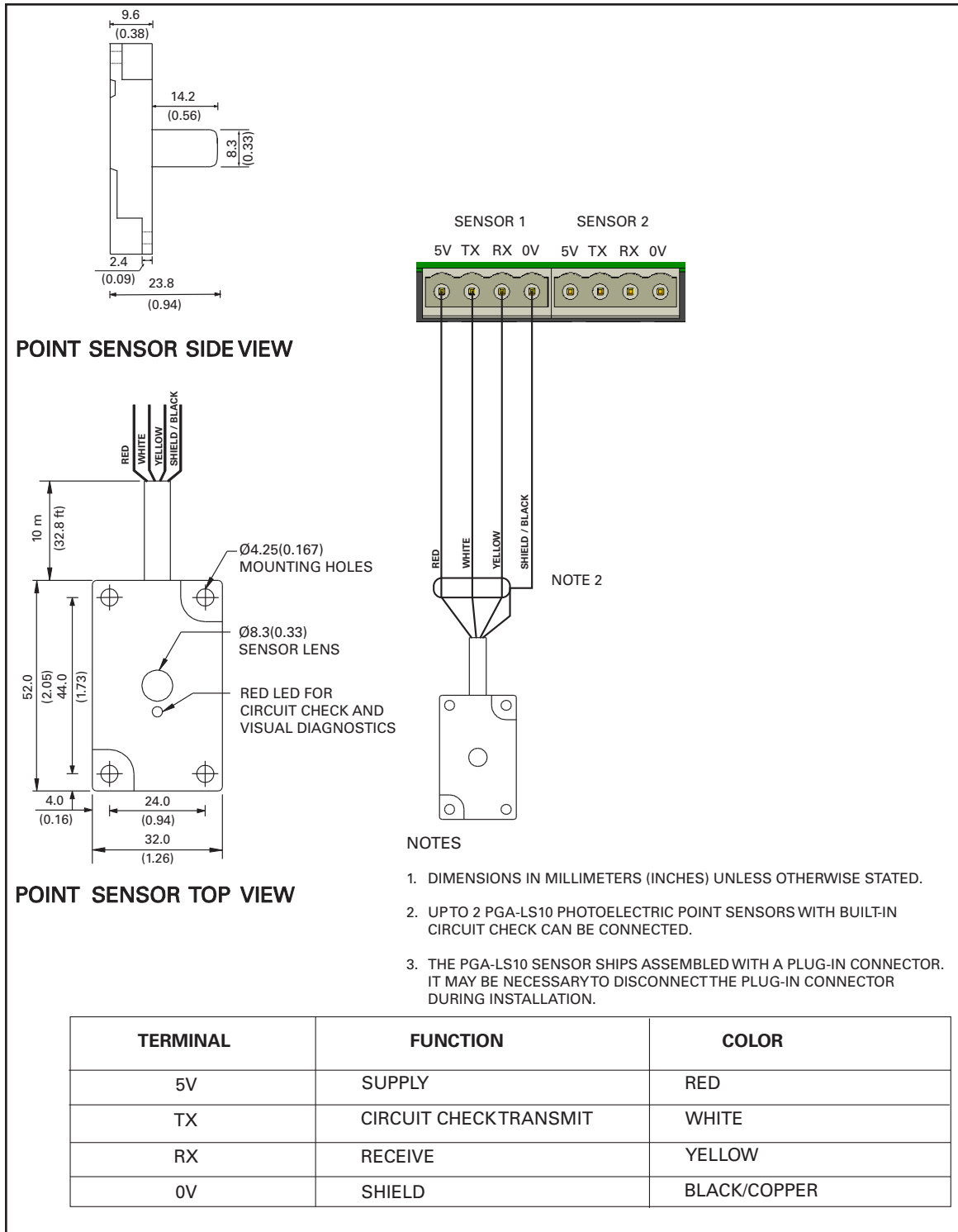

FIGURE 5. PGA-LS10 Connection Diagram.

4.1.2 PGA-LS10 Installation

The PGA-LS10 point sensor includes an adhesive-backed drill template for easy surface or panel-mount installation.

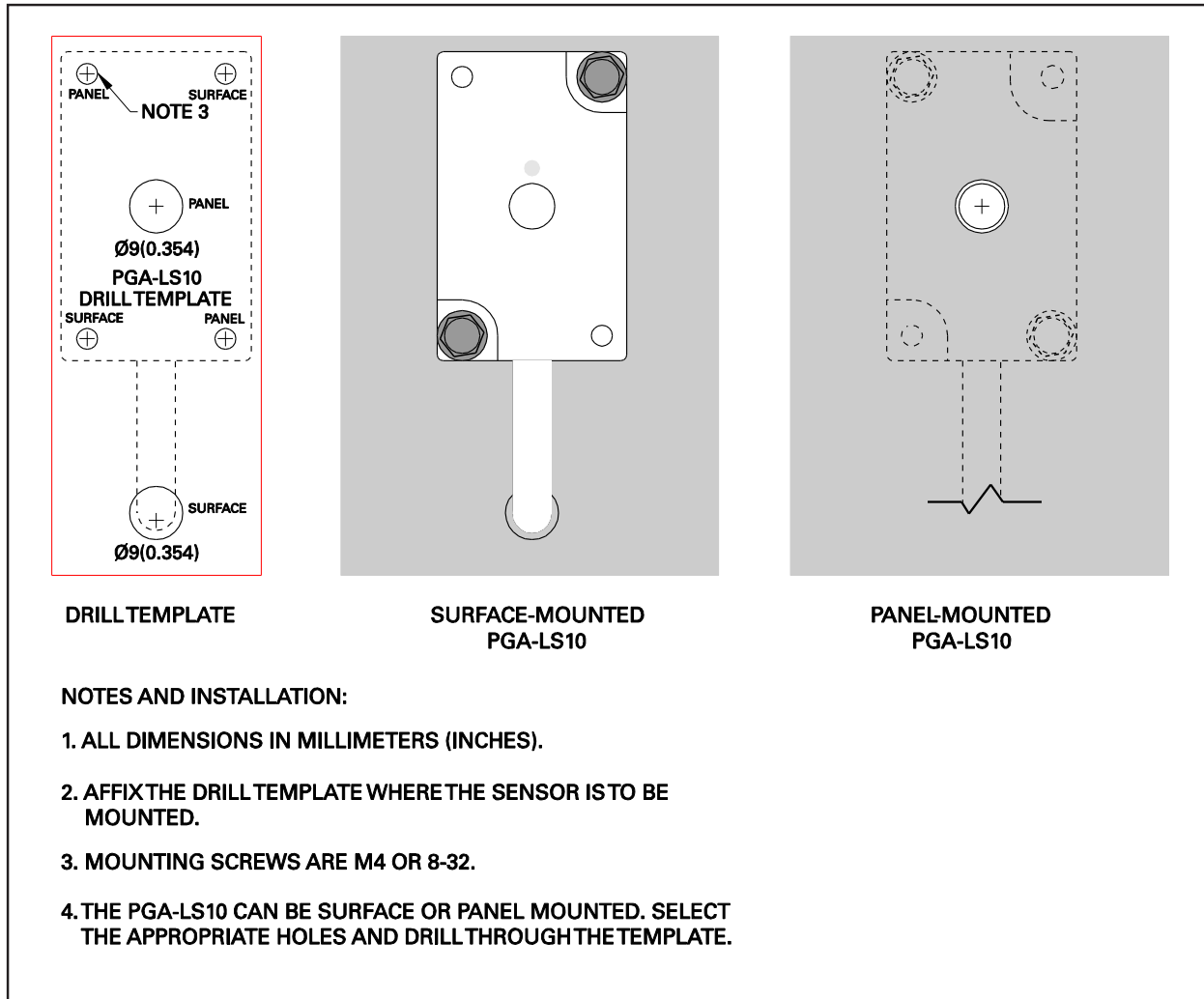

FIGURE 6. PGA-LS10 Mounting Detail.

4.2 PGA-LS20 and PGA-LS30 Fiber-Optic Sensors with Sensor Check

The PGA-LS20 and PGA-LS30 sensors have a 360° detection zone along the fiber's length. A built-in LED enables the AF0100 to verify the function of the light sensor, wiring, and electronics. If the sensor does not detect the sensor-check LED, a sensor-fail alarm will occur. The ERROR output will change state, and both the LED on the front panel and the indicator LED in the sensor itself will begin to flash red. See Section 7.

The PGA-LS20 and PGA-LS30 sensors have three components:

1. A fiber-optic cable, with one end covered with a black sleeve.
 - PGA-LS20 has 8 m (26 ft) of active fiber and 2 m (7 ft) of covered fiber.
 - PGA-LS30 has 18 m (59 ft) of active fiber and 2 m (7 ft) of covered fiber.
2. A transmitter with a white enclosure and a white thumb nut.
3. A receiver with a white enclosure, a black thumb nut, and an adjustment screw behind an access hole.

Both the receiver and the transmitter connect to one AF0100 input using shielded three-wire electrical cable. All three components are monitored to ensure correct operation.

4.2.1 Fiber Connection

The fiber is the light-collecting element of the PGA-LS20 and PGA-LS30. It must be installed so it has line-of-sight to all current-carrying parts. In some cases this may be accomplished by following the bus bars along the back wall of the cabinets.

Drill holes using the included drill template and fasten the transmitter and receiver to the cabinet walls using rivets or screws. Connect the attached cables to the AF0100. The wires of the transmitter and receiver must be connected as shown in Fig. 7.

Connect the black-sleeve-covered end to the receiver using the black thumb nut, and the white uncovered end to the transmitter using the white thumb nut. Ensure the fiber is inserted completely into the transmitter and receiver and the nuts are tightened. Pull gently on the cable to verify a secure connection. The maximum pull strength of the fiber is 30 N (6.7 lb_f).

The fiber should not be sharply bent or pinched. The minimum bending radius is 5 cm (2 in). Ensure that any drilled holes are free of any sharp edges or burrs. Use grommets for further protection.

NOTE: Removing the fiber from the transmitter can cause a trip if the fiber end is pointed towards a light source, since the fiber conducts light. This can also happen if the receiver is pointing directly towards a light source without a fiber connected. To guard against nuisance tripping, remove the trip coil terminal blocks before connecting and disconnecting sensors and fibers, or perform the maintenance while the system is de-energized.

4.2.2 Receiver Wiring Connections

Connect the red wire to 5V.
Connect the yellow wire to RX.
Connect the white wire **and** the shield to 0V.

4.2.3 Transmitter Wiring Connections

Connect the red wire to 5V.
Connect the white wire to TX.
Connect the shield to 0V.

The yellow wire is not used.

4.2.4 PGA-LS20 and PGA-LS30 Connection

The sensor is shipped with the wires mounted in a terminal block. See Fig 7.

The transmitter and receiver include 10 m (33 ft) of shielded three-wire electrical cable which can be shortened or extended up to 50 m (164 ft). Transmitter and receiver cables can be different lengths and must be independently shielded.

Failure to independently shield transmitter and receiver cables can lead to an incorrect circuit check – a faulty sensor could be falsely detected as continuous. However, if there is no sensor fault, arc-flash detection will function normally in this condition. For more information on sensor cabling, see Section 6.3.2.

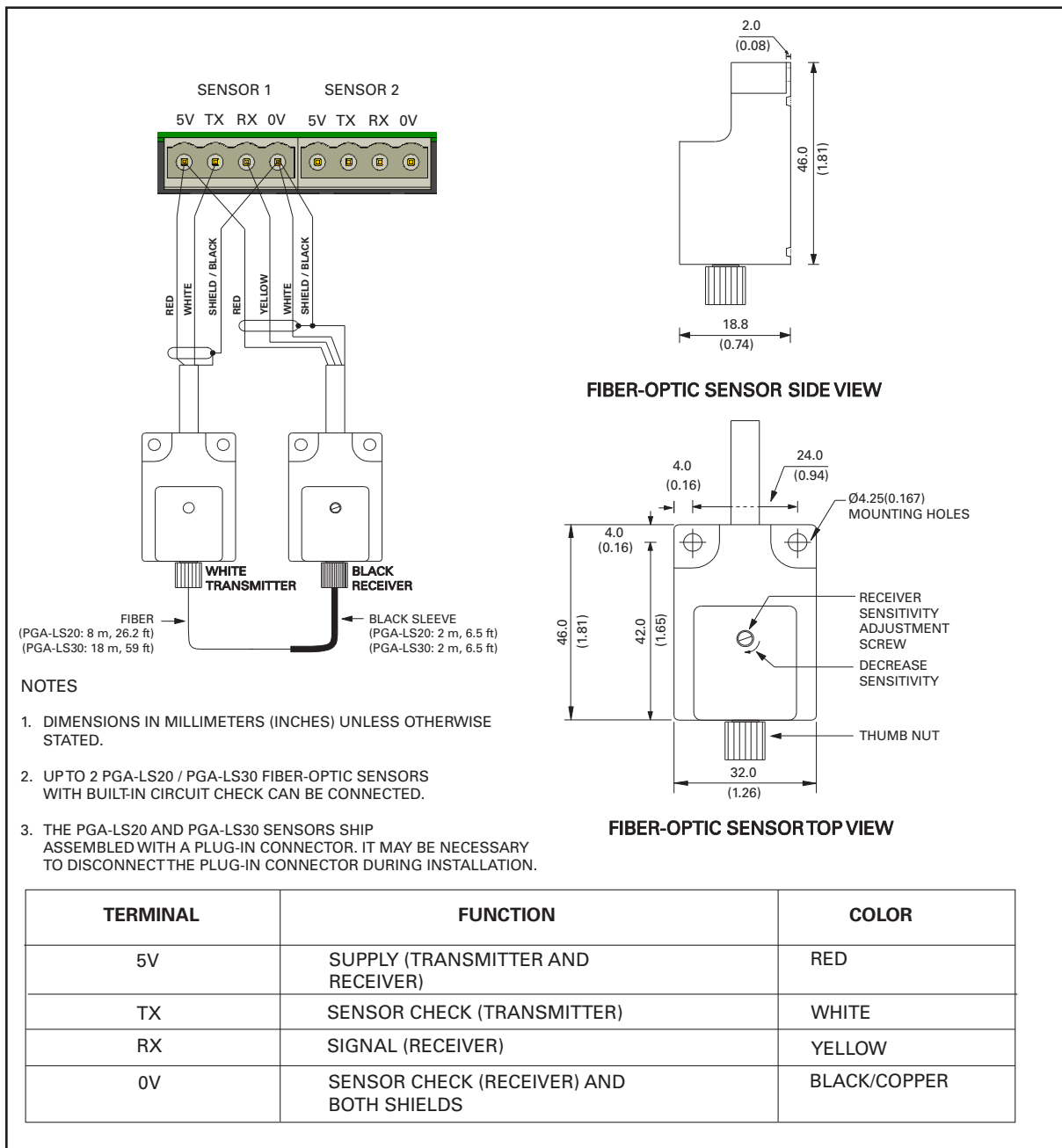

FIGURE 7. PGA-LS20 and PGA-LS30 Connection Diagram.

4.2.5 Fiber-Optic Sensor Adjustment

The sensor is calibrated at the factory for 60 cm (24 in) of fiber in each monitored compartment. When using a fiber-optic sensor in compartments with less than 60 cm (24 in) of fiber, the sensitivity may have to be adjusted. The sensor is unable to differentiate between 10,000 lux on 60 cm (24 in) of fiber and 30,000 lux on 20 cm (8 in) of fiber – the same amount of light is transmitted through the fiber to the receiver. To achieve the desired sensitivity, the receiver (with the black thumb nut) must be adjusted.

4.2.6 Sensor Adjustment For a Fiber Length Other Than 60 cm (24 in)

To adjust the fiber length, a powerful light source of at least 100 lumen (e.g. 500 W halogen lamp) and a spare point sensor is required. Use the following procedure to calibrate the sensor:

1. Remove the trip coil connector to avoid tripping the circuit breaker while testing.
2. Use a point sensor to find the distance to the lamp at which the sensor just trips. Note the distance between the lamp and the point sensor (typically 15-40 cm (5.9-15.7 in), depending on the lamp).
3. Adjust the receiver (black thumb nut) sensitivity level to the minimum by turning the small metal screw clockwise until it begins to click. This may be too low to detect the sensor-check signal and may cause the related LED on the relay to flash red to signal the error. This has no implication for the rest of the procedure, since the trip signal is transmitted anyway.
4. Place the lamp facing the fiber in the compartment closest to the transmitter end (white thumb nut) of the fiber. This allows for loss along the full length of the fiber. The distance between the lamp and the fiber should be the same as the distance observed in step 2.
5. Slowly turn the metal screw on the receiver counter-clockwise until the AF0100 sensor-indicator LED for that sensor changes to red, indicating a trip.
6. Press reset on the relay, and check that the sensor indicator LED turns green, indicating that the sensor-check signal is detected, and that the fiber is thus protected by circuit check.

If the system compartment is very small, it may not be possible to adjust the fiber to provide sufficient sensitivity. Contact Littelfuse for support.

5 APPLICATION EXAMPLES

5.1 Basic scenario: One Sensor – One Circuit Breaker

No configuration necessary.

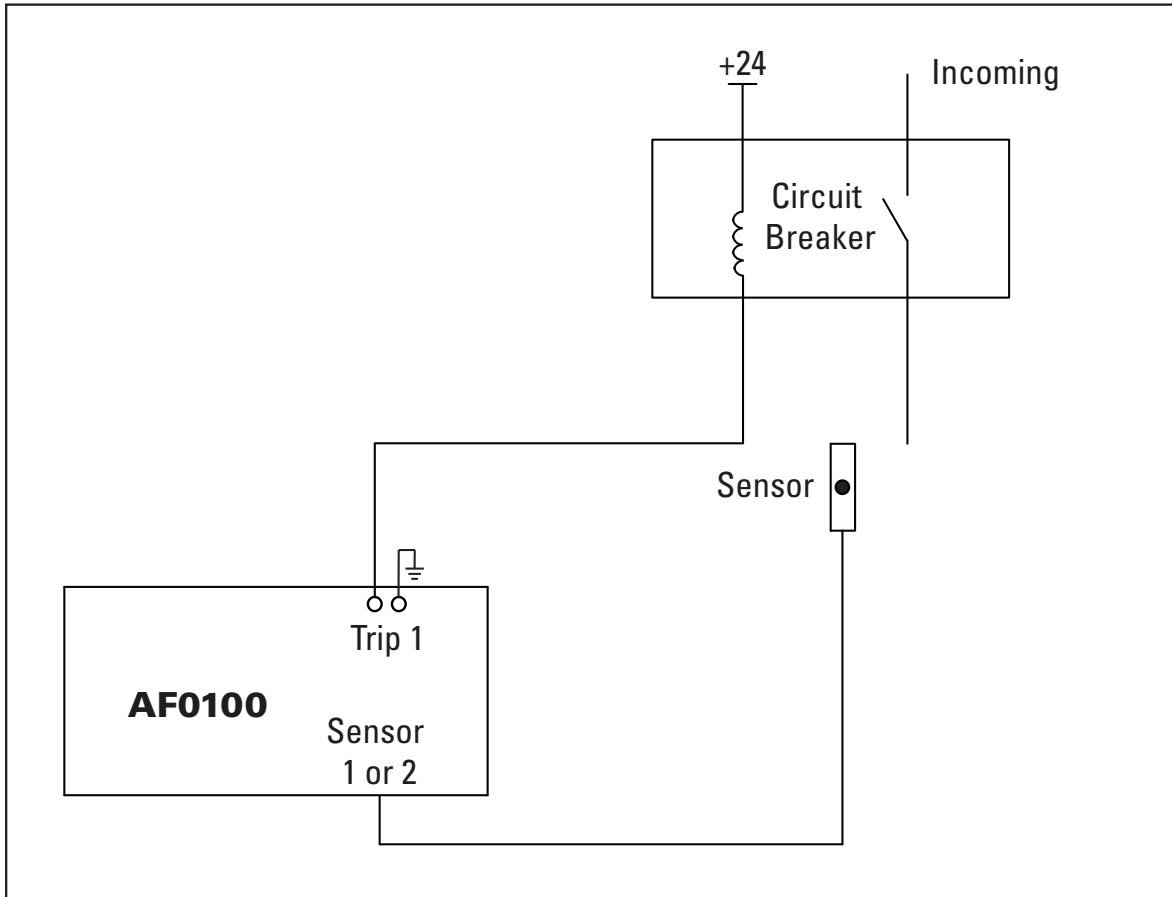

FIGURE 8. Basic AF0100 Configuration.

5.2 Total Clearing Time

The AF0100 is capable of tripping a circuit breaker in less than 5 ms (typical) from when light hits the sensor. This is not the same as the clearing time for the fault. The arc fault will continue until the current to the fault has stopped flowing, which happens when the circuit breaker connected to the unit has reacted.

5.2.1 Arc-Detection Delay

The AF0100's default arc-flash detection intentional delay time is 1 ms, but can be configured between 0 and 10 ms via the USB configuration software.

The total operating time will be the intentional delay plus the relay operating time based on wiring and configuration. The AF0100 operating times with no intentional delay are shown below.

OPERATING MODE	CONTACT CONFIGURATION	TRIP TIME
Shunt (Non-fail-safe)	N.O. (Normally Open)	< 5 ms
	N.C. (Normally Closed)	< 3 ms
Undervoltage (Fail-safe)	N.O. (Normally Open)	< 3 ms
	N.C. (Normally Closed)	< 8 ms

5.2.2 Circuit Breaker Operating Time

Circuit breakers have a predetermined operating time, dependent on the type of circuit breaker. Older circuit breakers have clearing times up to eight cycles, while modern circuit breakers are able to open in one to five cycles. Refer to the specifications of the installed circuit breaker.

TABLE 1. CIRCUIT BREAKER OPERATING TIME.

CIRCUIT BREAKER OPERATING TIME	50 HZ	60 HZ
8 cycles	160 ms	133 ms
5 cycles	100 ms	83 ms
3 cycles	60 ms	50 ms
2 cycles	40 ms	33 ms
1½ cycles	30 ms	25 ms
1 cycle	20 ms	17 ms

The total clearing time is:

Total Clearing Time = Arc-Detection Delay + Local Circuit Breaker Operating Time

With the AF0100, the dominating time by far is the circuit breaker operating time.

5.2.3 Total Clearing Time Examples

Example: Total Clearing Time with a 3-cycle circuit breaker

A 3-cycle circuit breaker at 50 Hz tripping due to light on an AF0100 sensor will have a total clearing time of:

$$5 + 60 = 65 \text{ ms}$$

It is possible to reduce the total clearing time by installing special devices, which shunt the current away from the arc fault. These can be found with clearing times down to 1-2 ms, reducing the total clearing time down to less than 7 ms.

6 INSTALLATION AND TERMINALS

The AF0100 can be surface mounted using two #6 screws (19mm or longer), or it can be DIN-rail mounted.

Ensure there is enough clearance around the module to allow the plug-in terminals to be removed and inserted.

Do not install modules which have been damaged in transport.

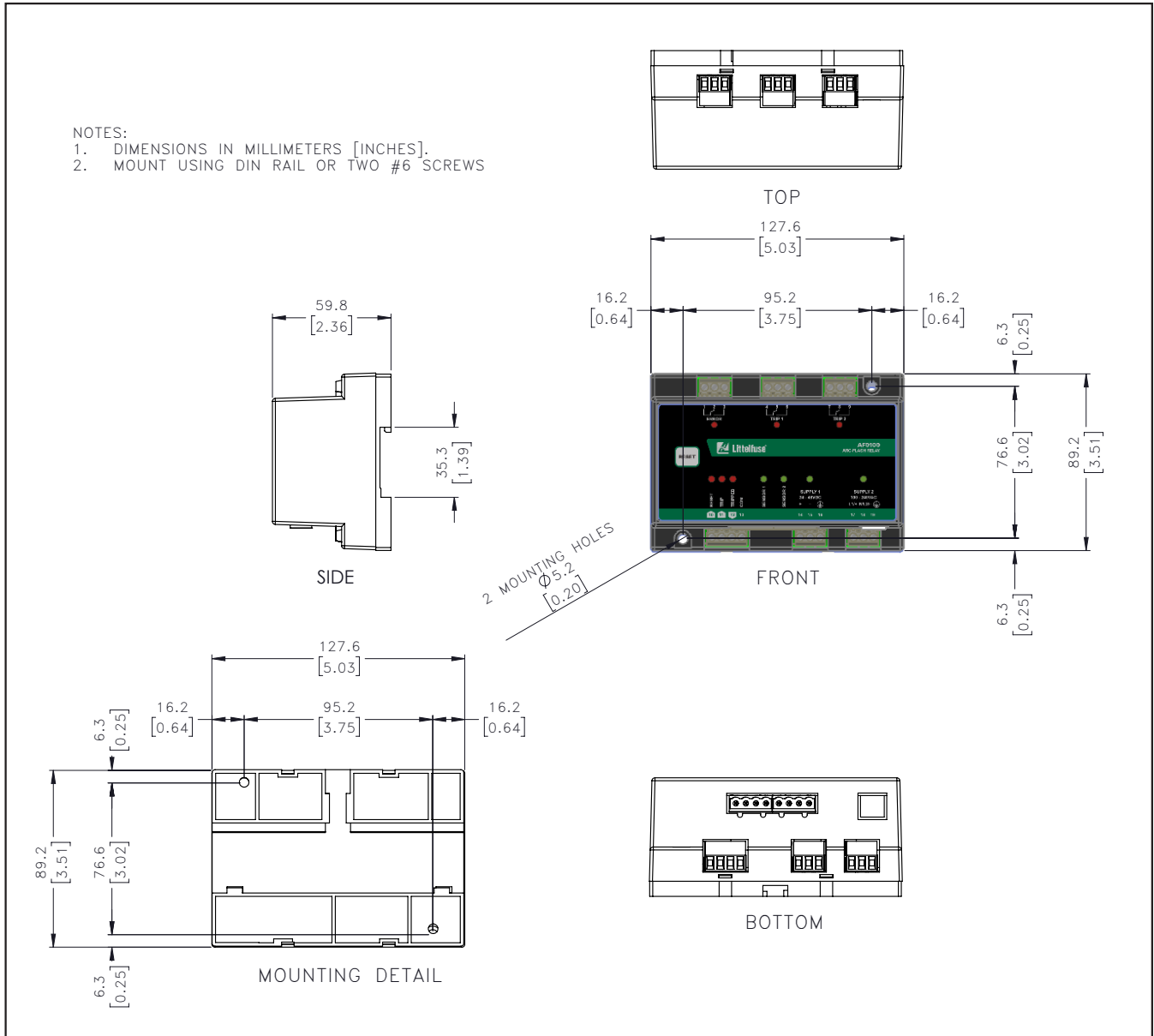

FIGURE 9. AF0100 Outline and Mounting Details.

6.1 Power Supply

The AF0100 Arc-Flash Relay can be supplied by either a high voltage ac or dc supply, an auxiliary low voltage supply, or both.

6.1.1 Line AC Supply (optional)

Connect an ac supply to terminals 17 and 18. The supply voltage must be 100 to 240 Vac.

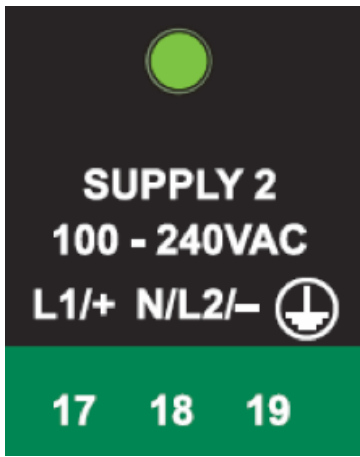

6.1.2 Station Battery DC Supply (optional)

Connect a dc supply to terminals 17 and 18. The supply voltage must be 100 to 240 Vdc.

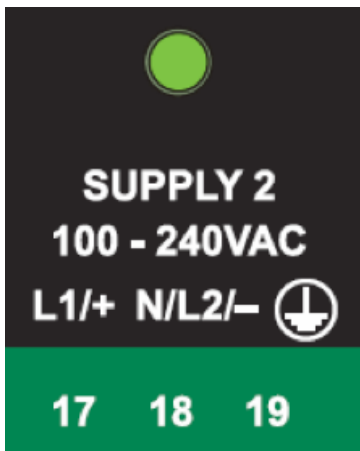

6.1.3 Auxiliary DC Supply

Connect a dc supply to terminals 14 and 15, ensuring correct polarity. The supply voltage must be 24 to 48 Vdc.

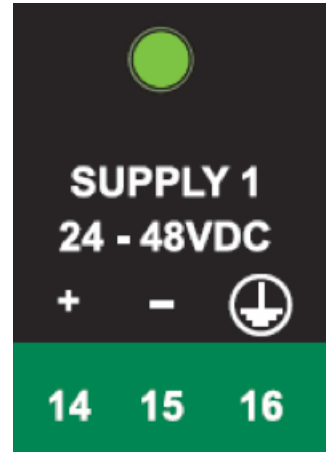

6.1.4 Supply Surveillance

The AF0100 will automatically learn which supplies to expect, and will indicate an error if one of the supplies is missing or out of nominal range. This is useful to make sure that a failure in a redundant supply is detected.

The error will auto-reset when the supply is re-established or can be cleared by holding the RESET button for 20 seconds. This will redetect any connected sensors and power supplies. See Section 7.1 for more information on the RESET button.

6.2 Inputs and Outputs

An LED provides visual indication of each input and output status. The output contacts are shown on the front panel in the de-energized state.

6.2.1 ERROR Signal Relay



The ERROR output signals the health of the arc-flash relay and its connected sensors and supplies.

The ERROR output consists of an insulated electromechanical change-over contact (Form C / SPDT) on terminals 1, 2, and 3. In the fail-safe mode, the ERROR relay will be energized when there are no alarms. The ERROR relay mode can be configured with the USB configuration software. See Section 7.3

If an error is currently active and an additional error occurs, the ERROR output will briefly change state. This is to communicate to connected equipment the error state has changed, but there are outstanding errors.

If possible, an LED on the front panel will indicate where the error is by flashing. Otherwise, the USB configuration software will show an overview of the current errors.

The ERROR relays of several units can be combined into one fail-safe signal by daisy-chaining terminals 2 and 3 (all ERROR relays must be configured for fail-safe mode). In that way, if just one of the linked units experiences an error, the

connection between the ends will be broken. Likewise, if the wire breaks, an alarm will be raised.

6.3 Sensors

Two optical sensors can be used with the AF0100. Sensor locations are identified as SENSOR 1 or SENSOR 2 on the top of the AF0100. See Section 4.

6.3.1 Light Immunity Adjustment

By default, the sensors will signal an arc-fault event if the light intensity is above approximately 10 klux. The light intensity from an arc fault is very high, typically in the area of 1 Mlux, and the choice of 10 klux is mostly a compromise between being sufficiently above normal light levels (about 1 klux in a very well lit office environment) and the need to be able to test the system with a manageable light source such as a flashlight.

The immunity level can be changed up to 25 klux via the USB configuration software. For information on using the USB configuration software, see Section 7.3.

This may be required for applications with powerful work lights or regulation requirements for the trip level.

The light sensors are not usable outdoors or in direct sunlight, as the intensity of direct sunlight will saturate the sensors.

6.3.2 Extending or Shortening Cable Length

Both point and fiber sensors are delivered with 10 m (33 ft) of three-wire shielded cable. If the installation requires it, these cables can be shortened or extended up to 50 m (164 ft). See Sections 4.1 and 4.2.4. Use Belden 85240 or equivalent cable (wire colors may vary).

Do not combine several sensor cables within the same shield. Do not combine the cables to transmitter and receiver for the fiber sensors within the same shield.

7 USER INTERFACE

7.1 Reset Button

The RESET button on the front panel of the AF0100 has two functions: A momentary press will reset any trip events or errors, and holding the button will initiate additional reset functions as described below.



Pressing the reset button will reset trip indications and error indications for any existing error. The error indication will remain if the error is still present and cannot be reset, e.g. if a sensor is missing or a supply voltage is outside the specification.

Holding the reset button for 10 seconds will reset the internal drive to factory defaults. This does not affect the configuration.

Holding the reset button for 20 seconds will redetect any connected sensors and power supplies which will clear the alarms. Do not do this until the reason for the alarm is known, and has been rectified.

If password protection is enabled in the USB configuration, resetting the list of connections is not allowed. In this case, use the USB configuration software to reset the alarm.

7.2 LED Indication and Relay Operation

Input LED's follow the input state. Since the TRIPPED digital output is pulsed, its LED will indicate if the output has been activated since the last reset. Blinking LED's on the front panel indicate errors e.g. an expected sensor is missing, etc. To reset the expected state, use the RESET button.

SUPPLY 1 and 2 (Terminals 14 to 16 and 17 to 19, respectively)

On, green Supply voltage is connected.

Flashing green Supply voltage on this terminal has previously been detected, but is now missing, or the connected supply is outside the specifications.

Off Supply voltage is not connected.

ERROR Relay (Terminals 1 to 3)

On, red An error has been detected, and the ERROR relay has been de-energized (fail-safe mode) or energized (non-fail-safe mode). If another LED is flashing, use this to localize the error and correct the problem. The USB configuration software can also be used to show the cause for any standing alarm, see section 7.3.

Off No errors detected.

The LED will not always follow the internal contacts. The ERROR relay will be in the state shown on the front panel when power is not connected.

In the fail-safe mode, the ERROR relay will energize if no errors are detected, and will de-energize on errors, or if power is removed.

In the non-fail-safe mode, the ERROR relay will de-energize if no errors are detected or if power is removed, and will energize on errors.

The ERROR relay will also pulse for one second if an additional error is detected while errors are already present.

TRIP 1 and TRIP 2 (Terminals 4 to 6 and 7 to 9, respectively)

On, red A TRIP output is or has been active due to an arc-flash event. Press RESET to clear the trip.

Off No unacknowledged trips.

The LED will not always follow the status of the internal contacts. The trip relays are shown on the front panel in their de-energized state.

In the fail-safe mode, trip relays will energize when not in a tripped state, and will de-energize when in a tripped state, or if power is removed.

In the non-fail-safe mode, the trip relays will de-energize when not in a tripped state, or if power is removed, and will energize when in a tripped state.

RESET Input (Terminal 10)

On, red RESET input or another reset source (RESET button) is active.

Off RESET input is inactive.

If the RESET input is permanently activated, errors and trips will be reset as soon as they are cleared or completed.

TRIP Input (Terminal 11)

On, red TRIP input is active.

Off TRIP input is inactive.

TRIPPED Output (Terminal 12)

On, red The TRIPPED output is or has been active. Press RESET to clear the trip.

Off The TRIPPED output is inactive.

Sensors

On, green The sensor input is active and has a functional sensor connected.

On, red The sensor caused a trip event. The LED in the sensor will also be solid red. Press the RESET button to clear the trip.

Flashing red The circuit check of the sensor failed; check the wiring and that fiber sensors are fully seated in the thumb screws. If possible, the LED in the sensor will also be flashing red. If a sensor has been removed temporarily or on purpose, press and hold the RESET button for a 20 seconds to redetect any connected sensors.

Off The input has not detected a connected sensor. The input will by default still be active.

PGA-LS10, PGA-LS20 and PGA-LS30

Flashing Red The sensor is operating normally.

On, red (brief flashing red every 2 s) The sensor caused a trip event.

Off The sensor is unplugged or faulty, or the AF0100 is without power (check the wiring and that fiber sensors are fully seated in the thumb screws).

7.3 USB Configuration Software

To access the configuration software, plug in a USB connector and connect to a Windows¹ computer.

After a few seconds, the following will appear:

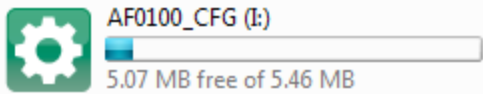

Open the Configuration drive, and double click on the file named 'config.hta'

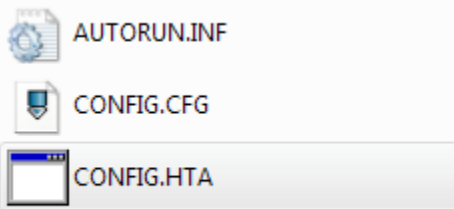

The configuration software will now open.

Tabs show each logical section of the relay.

Hovering above each setting will display the valid limits for the setting.

Press the Save button and remove the USB connector to apply the new configuration.

NOTE:

¹ All Microsoft Windows versions from and including Windows XP are supported. Some corporate networks may disallow HTA applications, in which case you should contact your system administrator to allow local HTA files to run.

AF0100 Configuration Software

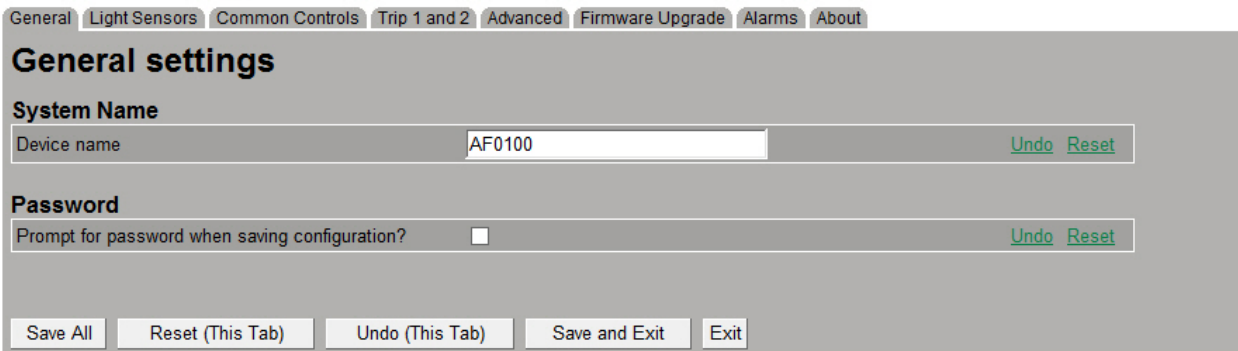

It is not possible to view live data from the unit via USB. The values shown for e.g. sensor state are the values at the moment the USB connector was plugged in. Setting the

password in the USB configuration software will prevent the list of connected devices from being reset via the reset button on the front panel.

7.3.1 USB Configuration Software – Screen Examples

AF0100 Configuration Software

General Light Sensors Common Controls Trip 1 and 2 Advanced Firmware Upgrade Alarms About

Light Sensors settings

Common settings

Minimum light level before tripping [10 - 25 klux]	<input type="text" value="25"/> klux	Undo Reset
Arc detection time before tripping [0 - 10 ms]	<input type="text" value="1"/> ms	Undo Reset

Light sensor 1

Sensor status (when USB cable was attached)	Sensor present	
Sensor description	<input type="text" value="Sensor 1"/>	Undo Reset
Change configuration	<input type="text" value="No change"/> ▼	Undo Reset

Light sensor 2

Sensor status (when USB cable was attached)	No sensor detected	
Sensor description	<input type="text" value="Sensor 2"/>	Undo Reset
Change configuration	<input type="text" value="No change"/> ▼	Undo Reset

Save All Reset (This Tab) Undo (This Tab) Save and Exit Exit

AF0100 Configuration Software

General Light Sensors Common Controls Trip 1 and 2 Advanced Firmware Upgrade Alarms About

Common Controls settings

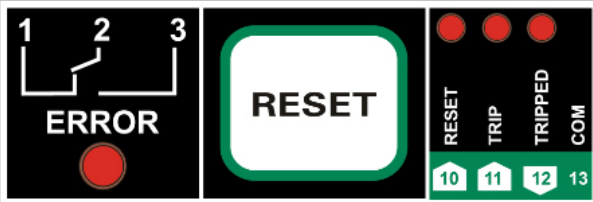

RESET button

Press to reset trip condition and resettable alarms.
When pressed and held for > 20 seconds, the expected sensors and power supplies are configured to match what is currently detected if configuration is not password protected.

ERROR relay

ERROR function	<input type="text" value="Failsafe"/> ▼	Undo Reset
----------------	---	--

RESET input

Nothing to configure
Activates when low

Save All Reset (This Tab) Undo (This Tab) Save and Exit Exit

AF0100 Configuration Software

General Light Sensors Common Controls Trip 1 and 2 **Advanced** Firmware Upgrade Alarms About

Trip 1 and 2 settings

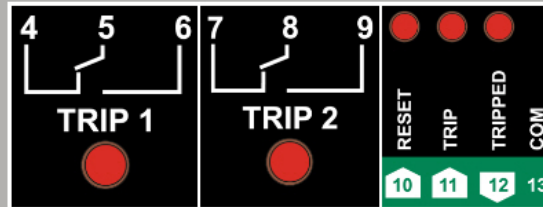

Trip sources

Light sensor 1 causes trip
Light sensor 2 causes trip

TRIP input

Enabled [Undo](#) [Reset](#)
Activates when low

TRIPPED output

Nothing to configure
Activates (pulses low) on trip

TRIP 1 Relay

TRIP function (Trip coil) Non-Failsafe (Shunt coil) [Undo](#) [Reset](#)

TRIP 2 Relay

TRIP function (Trip coil) Failsafe (Undervoltage coil) [Undo](#) [Reset](#)

Save All Reset (This Tab) Undo (This Tab) Save and Exit Exit

AF0100 Configuration Software

General Light Sensors Common Controls Trip 1 and 2 **Advanced** Firmware Upgrade Alarms About

Advanced

Reset device configuration

Reset discovered devices [Undo](#) [Reset](#)
This will make the AF0100 reset its internal list of detected sensors and power supplies to match what is currently detected.

Internal drives

Reset configuration drive to factory default [Undo](#) [Reset](#)
(Does not erase the configuration)

Configuration

Reset configuration to factory defaults [Undo](#) [Reset](#)

Save All Reset (This Tab) Undo (This Tab) Save and Exit Exit

AF0100 Configuration Software

General Light Sensors Common Controls Trip 1 and 2 Advanced Firmware Upgrade Alarms About

Firmware Upgrade

Firmware upgrade procedure

1. Copy AF0100.bin and AF0100.MD5 to AF0100_CFG drive
2. Disconnect the USB cable. The firmware upgrade progress is indicated on the SENSOR LEDs
3. The AF0100 will reboot when firmware upgrade is complete
4. Close Configuration Software and re-connect the USB cable
5. Open Configuration Software and verify that the firmware revision is correct in the About tab

Save All Reset (This Tab) Undo (This Tab) Save and Exit Exit

The USB configuration software also shows the cause of any standing alarms in clear text.

AF0100 Configuration Software

General Light Sensors Common Controls Trip 1 and 2 Advanced Firmware Upgrade Alarms About

Alarms

Currently standing alarms

No standing alarms.

Save All Reset (This Tab) Undo (This Tab) Save and Exit Exit

AF0100 Configuration Software

General Light Sensors Common Controls Trip 1 and 2 Advanced Firmware Upgrade Alarms About

About



Version information

Product type: AF0100
Product SW Version: 2017-02-07 (01.00.01-00)
Product HW Version: 1
Product serial number: 7000008

Save All Reset (This Tab) Undo (This Tab) Save and Exit Exit

7.4 Firmware Upgrade

NOTE: The AF0100 will restart during the firmware upgrade process. The TRIP and ERROR relays may change state. Ensure the equipment is in a safe state prior to starting the upgrade process. Do not interrupt the firmware upgrade process.

NOTE: The redundant trip circuit is active during the firmware upgrade process, but will operate in a shunt-trip mode only. Once the firmware upgrade process has completed, normal operation will continue as previously configured via the configuration software. See Appendix B for more information.

Product information, including hardware and firmware details, can be reviewed in the About tab as shown in Section 7.3.1.

Follow the procedure below to perform a firmware upgrade:

1. Contact Littelfuse at relays@littelfuse.com to obtain the newest firmware file.
2. Connect the AF0100 to a computer using a USB cable. See Section 7.3.
3. Copy the AF0100.bin and AF0100.md5 files to the AF0100 Configuration drive.

4. Disconnect the USB cable. The firmware upgrade will begin. Progress will be shown on the front panel as outlined below. The firmware upgrade can take up to five minutes.

TABLE 2. AF0100 FIRMWARE UPGRADE SEQUENCE.

Sensor 1	Sensor 2	Description
		Sensor 2 flashing
		Sensor 1 flashing
		Sensor 1 ON, Sensor 2 flashing
		Sensor 1 flashing, Sensor 2 ON
Unit reset		AF0100 will reset
		Sensor 1 and 2 flashing green for 3 seconds – Upgrade passed
Unit reset		AF0100 will reset
Firmware upgrade process complete.		

Legend:



5. The AF0100 will restart twice when the firmware upgrade has been completed.
6. Close the Configuration Software screen (HTA file).
7. Reconnect the AF0100 to the computer as in Step 2.
8. Confirm that the firmware revision shown in the About tab is correct.

8 COMMISSIONING

With no manual configuration, a freshly unpacked and wired AF0100 will work using the factory default settings. It will trip the TRIP 1 and TRIP 2 outputs if light applied to any sensors connected to SENSOR 1 or SENSOR 2 exceeds the default setting of 10 klux, even if a circuit check is reporting a cable to be broken.

The digital I/O (TRIP and RESET inputs, TRIPPED output) will also be enabled.

Littelfuse recommends always doing a full system test on all sensors and outputs to ensure that any errors in the cabling or configuration will be detected and can be corrected before the system is put into normal operation.

CAUTION: Make sure that the area is safe before this test. Ensure that loads and power are disconnected at the transformers, etc.

8.1 Configuration of Installed Sensors

The AF0100 will auto-detect sensors as they are connected. To reset any errors (shown as blinking red LED in a position where no sensor is attached), e.g. after moving a sensor to another position on the unit, press and hold the RESET button for 20 seconds. This will redetect any connected sensors and power supplies.

8.2 Testing the Sensors

To test the tripping of point sensors, the intensity of light at the sensors needs to rise above 10 klux (or the defined light immunity setting, if changed). The LED flash on most phones are not sufficient, nor are most LED flashlights. Most incandescent flashlights (e.g. Mini Maglite with Xenon bulb or larger) can be used, if the beam can be focused to a very small circle and the flashlight is brought right next to the sensor. A normal AC light bulb can also be used.

For fiber sensors, the light intensity needs to be above 10 klux on a much larger area, which is not possible with a flashlight or standard light bulbs. To test fiber sensors, a 300-500 W halogen lamp or a powerful photo flash with a guide number of at least 15 m (50 ft) is needed. See Section 10.7.

1. Unplug the TRIP outputs to avoid tripping the circuit breakers. If the AF0100 output is connected to other devices, disconnect these connectors as well.
2. Confirm that there is a solid green LED for each connected optical sensor. This confirms that sensors are connected and healthy.
3. Confirm that a short red flashing light occurs periodically in each sensor. This indicates that the sensor circuit is being checked.
4. Point the light source at a sensor and check that the LED on the sensor and the front panel of the AF0100 turns red continuously. The TRIPPED LED will also turn on. If this does not happen, the light source may not be powerful enough, especially for fiber sensors.
5. Repeat for the remaining sensors.
6. Check that the indicator LED's on the front panel of the unit have turned red for all connected sensors.
7. Press the RESET button to clear the trip indication.

Replace any connectors removed to re-establish protection.

8.3 Testing the TRIP 1 and TRIP 2 Outputs and Associated Circuit Breakers

To ensure the system is ready to test, the system should only have supply power. The TRIP 1 and TRIP 2 outputs will be tripped during this procedure. Also be aware that other devices connected to the trip outputs will also trip, unless the connection is removed for the test.

1. Reset the AF0100. Ensure there are no trips or errors present.
2. Connect the TRIP input to COM using a piece of wire, terminals 11 to 13.
3. Observe that the connected trip coil operates.
4. Press the RESET button to reset the trip indication. Reset the tripping device if necessary.
5. Replace any connectors removed to re-establish protection.
6. Repeat for each TRIP 1 and TRIP 2 output.

2. Make a table with a row for each sensor, and mark which circuit breakers should trip in order to remove power completely from the area. See Table 2.
3. Confirm that there is a solid green LED for each connected optical sensor. This confirms that sensors are connected and healthy.
4. Confirm that a short red flashing light occurs periodically in each sensor. This indicates that the sensor circuit is being checked.
5. Move a light source towards the sensor. Confirm that the TRIP1 and TRIP 2 outputs trip and that the LED's of the TRIP outputs and sensor change to red. Confirm that all circuit breakers which supply the area which the sensor can see have tripped. Note the result in the table.
6. Press RESET on all affected units, and reset the tripping device if necessary.
7. Repeat steps 3 to 6 for the remaining sensors.

8.4 Full Operation Test

To ensure the system is ready to test, the system should only have supply power. The TRIP outputs will change state during this procedure.

1. Use the system diagram to find out which circuit breakers should trip for each sensor. Generally, the system should be set up so that light on a sensor removes power from any conductor that the sensor can see.

TABLE 3. SAMPLE TABLE FOR TESTING A SYSTEM.

SENSOR:	SHOULD TRIP THESE CIRCUIT BREAKERS:	OBSERVED TRIPS:
Unit 1, sensor 1 Placed on Busbar	Incoming Circuit Breaker 1	
Unit 1, sensor 2 Placed in Circuit Breaker 2 Cabinet	Incoming Circuit Breaker 1	
Unit 2, sensor 1 Placed in Circuit Breaker 3 Cabinet	Circuit Breaker 2	
Etc.		

9 SUPPORT RESOURCES

The most up-to-date manuals, data sheets, instruction videos, etc. can be found on the AF0100 site at www.littelfuse.com/AF0100.

The AF0100 is supported through the Littelfuse network of technical sales and distributors. For installation help and support, please contact your sales representative. Include detailed information about the installation and application. See Section 2.

9.1 Sending Information For Support

A picture or video of the installation makes it much easier to provide assistance. Also, the configuration and log files can be very helpful, as is the serial number of the unit.

Attaching the files to the support email can be done as follows:

Plug in a USB connector and connect to a computer.

After a few seconds, one new drive appears.

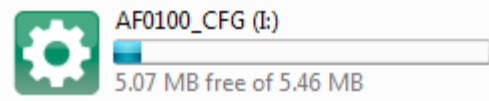

From the CFG drive, select and attach the CONFIG.CFG, AF0100.LOG, and AF0100.TXT files.

Provide a single line diagram of the installation if possible.

10 SPECIFICATIONS

10.1 AF0100

Supply:

Supply 1:.....4 W, 24 to 48 Vdc
 (+10%, -25%)
 Supply 2:.....10 VA, 100 to 240 Vac
 AF0100-00 only (+10%, -20%) 50/60 Hz,
 5 W, 100 to 250 Vdc
 (+10%, -20%)

Optical Settings:

External Sensors:.....2 Light sensors
 Sensor Types:.....PGA-LS10, PGA-LS20, and
 PGA-LS30, all with sensor
 check

Immunity

Adjustment:Trip above 10 to 25 klux

Intentional Trip

Delay Settings:0 to 10 ms
 0 ms intentional delay
 results in a maximum 0.8
 ms total delay (plus relay
 operate time)

TRIP 1 and TRIP 2 Outputs:

Configuration:Change-over (Form C)
 isolated contact
 UL Rating6 A resistive 240 Vac,
 6 A resistive 30 Vdc

Supplemental Ratings:

Make/Carry 0.2 s:30 A
 Rating Code:B300, R300
 Minimum Switching Load...100 mA, 5 Vdc
 Maximum Switching
 Capacity.....Fig. 17
 Break:
 dc:.....28 W Resistive
 ac:1500 VA (PF=1.0)
 360 VA (PF=0.4)
 Subject to maximums of
 6 A and 250 V (ac or dc)

Operating Mode:.....Shunt trip (non-fail-safe)
 or undervoltage trip
 (fail-safe), independently
 configurable

Isolation:.....1,600 Vac

Trip Time (with 0 ms intentional delay):

Mode:

Shunt Trip (non-fail-safe):

Normally open contact:.....< 5 ms

Normally closed contact:.....< 3 ms

Undervoltage Trip (fail-safe):

Normally open contact:.....< 3 ms

Normally closed contact:.....< 8 ms

Error Output:

Configuration:Change-over (Form C)
 isolated contact

UL Rating:.....6 A resistive 240 Vac,
 6 A resistive 30 Vdc

Supplemental Ratings:

Make/Carry 0.2 s.....30 A
 Rating Code:.....B300, R300
 Minimum Switching Load..100 mA, 5 Vdc
 Maximum Switching
 Capacity.....Fig. 17

Break:

dc:.....28 W Resistive

ac:.....1500 VA (PF=1.0)

360 VA (PF=0.4)

Subject to maximums of 6
 A and 250 V (ac or dc)

Operating Mode:Fail-Safe or Non-Fail-Safe

Isolation:1,600 Vac

Redundant Circuit Trip Time.....10 ms max,
 Shunt Trip Operation Only
 See Appendix B.

Terminals.....Wire Clamping, 22-12
 AWG (0.14 to 2.5 mm²)
 copper conductors

Torque:.....7 lbf-in (0.79 N·m)

Local Interface:USB 2.0 Full speed Mass
 storage device

Dimensions:

Height:.....90 mm (3.5 in)

Width:128 mm (5.0 in)

Depth:.....60 mm (2.4 in)

Shipping Weight:0.9 kg (2 lb)

Mounting:.....	35 mm DIN rail or surface mount
Environment:	
Operating Temperature:	-40 to 70°C (-40 to 158°F)
Storage Temperature:	-40 to 70°C (-40 to 158°F)
Humidity:	93% Non-condensing
Enclosure Rating	IP20
Altitude:	
Below 2,000 m (6,500 ft):.....	Normal Operation
Above 2,000 m (6,500 ft):.....	24 Vdc supply only
Above 4,000 m (13,000 ft):.....	Contact Littelfuse for further information.

Conducted RF Immunity	IEC 61000-4-6 10 V, 0.15-80 MHz, 80% AM (1 kHz)
Magnetic Field Immunity.....	IEC 61000-4-8 50 Hz and 60 Hz 30 A/m and 300 A/m
Power Frequency ³	IEC 61000-4-16 Zone A: differential mode 100 Vrms Zone A: common mode 300 Vrms
1 MHz Burst	IEC 61000-4-18 ± 1 kV differential mode (line-to-line) ± 2.5 kV common mode
Voltage Interruption	IEC 61000-4-11, IEC 61000-4-29 0% for 10, 20, 30, 50 ms (dc) 0% for 0.5, 1, 2.5, 5 cycles (60 Hz) IEC 61000-4-17 Level 4, 15% of rated dc value
Surge Withstand:.....	ANSI/IEEE C37.90.1-2002 (Oscillatory and Fast Transient)

10.2 EMC Tests

Verification tested in accordance with EN 60255-26:2013.

Radiated and Conducted Emissions:.....	CISPR 11:2009, CISPR 22:2008, EN 55022:2010 Class A
Current Harmonics and Voltage Fluctuations	IEC 61000-3-2 and IEC 61000-3-3 Class A
Electrostatic Discharge	IEC 61000-4-2 ± 6 kV contact discharge (direct and indirect) ± 8 kV air discharge
Radiated RF Immunity	IEC 61000-4-3 10 V/m, 80-1,000 MHz, 80% AM (1 kHz) 10 V/m, 1.0 to 2.7 GHz, 80% AM (1 kHz)
Fast Transient	IEC 61000-4-4 Zone B ± 2 kV (power supply port), ± 1 kV (all other ports)
Surge Immunity	IEC 61000-4-5 Zone B ± 1 kV differential mode ± 2 kV common mode

10.3 Environmental Tests

Cold:.....	IEC 60068-2-1:2007
Test Temperature:.....	-40°C
Duration:.....	16 hours
Dry Heat:.....	IEC 60068-2-2:2007
Test Temperature:.....	70°C
Duration:.....	16 hours
Humidity:.....	50% RH
Damp Heat Cyclic.....	IEC 60068-2-30:2005
Lower Temperature:.....	25°C
Humidity Range:.....	95 – 100 % RH
Upper Temperature:.....	55°C
Humidity Range:.....	90 – 96 % RH
Number of Cycles:.....	2
Vibration:	
EN60225-21-1.....	Vibration, Shock, and Seismic
EN60225-21-2.....	Shock and Bump

10.4 Safety

Safety: IEC 61010-1: 2010 + AMD1:2016
3rd Edition
Safety Requirements for Electrical
Equipment for Measurement, Control,
and Laboratory Use – Part I

UL508 Industrial Control Equipment

10.5 Certification

Certification:



UL508 Industrial Control Equipment¹



Australia, Regulatory Compliance Mark (RCM)



CE, European Union
EMC directive 2014/30/EU: Certified to
IEC/EN 60255-26:2013

Low voltage directive 2014/35/EU: Certified to
IEC/EN 61010-1:2010 + AMD1:2016



FCC Part 15, Subpart B, Class A –
Unintentional Radiators

10.6 Sensors

	PGA-LS10	PGA-LS20 and PGA-LS30
Type:	Point sensor	Fiber-optic sensor
Detection Zone:	180 x 360° (half sphere)	360° along fiber
Output:	0-35 mA	0-35 mA
Electrical Cable:	Shielded 3-wire 20 AWG (0.5 mm ²) electrical cable	Shielded 3-wire 20 AWG (0.5 mm ²) electrical cable
Factory Cable Length:	10 m (33 ft) electrical cable	PGA-LS20: 8 m (26 ft) active; 10 m (33 ft) total (2 m (7 ft) shielded), 2 x 10 m electrical cable PGA-LS30: 18 m (59 ft) active; 20 m (66 ft) total (2 m (7 ft) shielded), 2 x 10 m (33 ft) electrical cable
Max. Elec. Cable Length:	50 m (164 ft)	50 m (164 ft)
Sensor Check:	Built-in LED for visual feedback	Built-in LED for visual feedback
Dimensions:	32 x 52 x 24 mm (1.3 x 2.0 x 0.9 in)	Transmitter and Receiver: 32 x 56 x 19 mm (1.3 x 2.2 x 0.7 in)
Enclosure:	IP 30	IP 30

10.7 Ordering Information

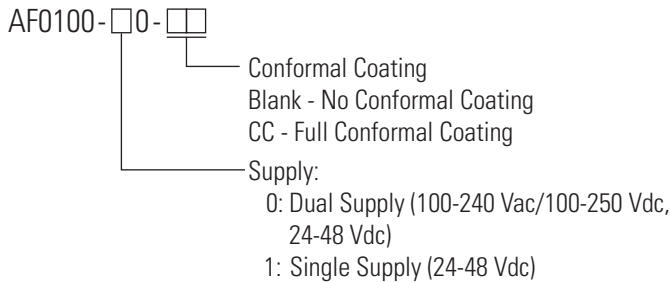

Accessories:

- PGA-LS10 Point Sensor
- PGA-LS20 Fiber-Optic Sensor, 8 m (26 ft) active length
- PGA-LS30 Fiber-Optic Sensor, 18 m (59 ft) active length
- PGA-FLSH-00 Photo Flash for commissioning testing
- PGA-FLSH-01 Photo Flash, CE and RoHS

10.8 Related Products

- AF0500 Stand-alone Arc-Flash Relay with 4 sensor inputs, 2 trip coil outputs, 2 zones
- PGR-8800 Stand-alone Arc-Flash Relay with 6 sensor inputs, 1 trip coil output, current inputs

10.9 Warranty

The AF0100 Arc-Flash Relay is warranted to be free from defects in material and workmanship for a period of five years from the date of purchase.

Littelfuse will (at Littelfuse’s option) repair, replace, or refund the original purchase price of a AF0100 that is determined by Littelfuse to be defective if it is returned to the factory, freight prepaid, within the warranty period. This warranty does not apply to repairs required as a result of misuse, negligence, an accident, improper installation, tampering, or insufficient care. Littelfuse does not warrant products repaired or modified by non-Littelfuse personnel.

NOTES:

1. The AF0100 Arc-Flash Relay is currently listed as a protective relay (UL category NRGU) and complies with the UL508 Industrial Control Equipment standard. UL did not evaluate the functionality of the arc-fault protection afforded by this product. A file review will occur when the requirements for investigation of arc detection and mitigation systems are developed and additional tests will be performed if required.
2. The AF0100 uses the open source component FreeMODBUS internally. For license, version, and source-code information please contact opensource@littelfuse.com.
3. Remote-reset wiring is limited to 10 m (32 ft).

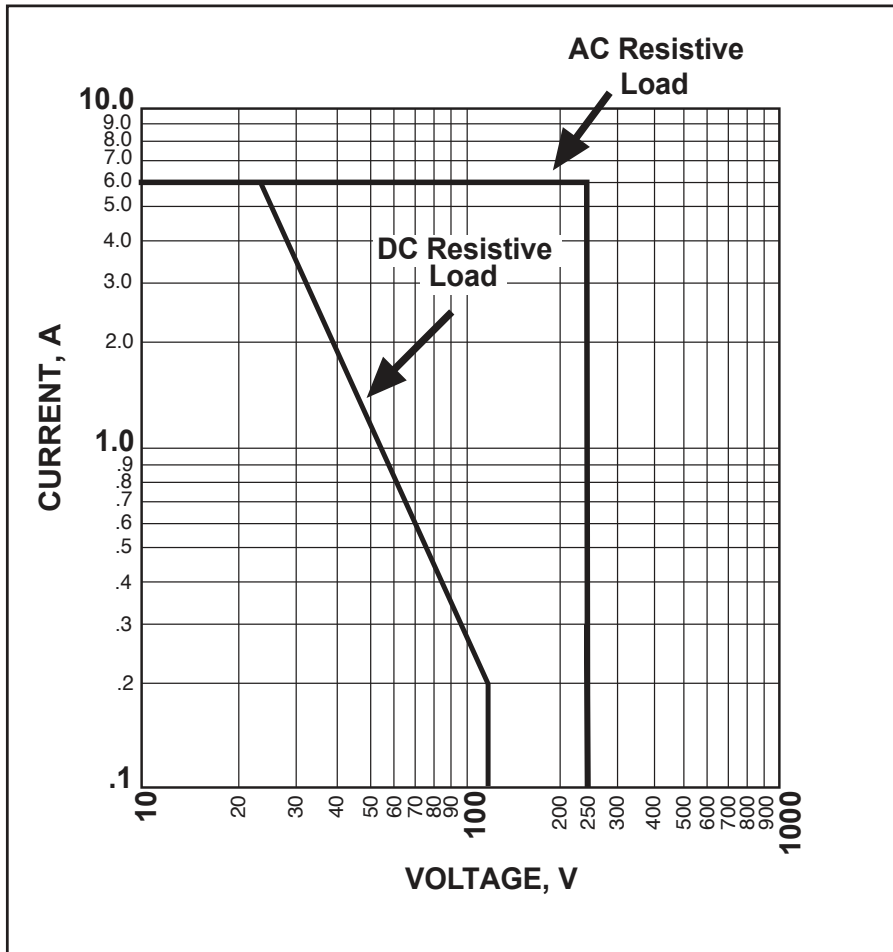

FIGURE 10. TRIP and ERROR Relays Maximum Switching Capacity.

APPENDIX A INSTALLATION LOG SHEET

GENERAL INSTALLATION SETTINGS	MIN	DEFAULT	MAX	UNIT	COMMENTS
Date Installed					
Operator					
Comment 1					
Comment 2					
GENERAL					
System Name					
Description Of This Unit		AF0100 Arc-Flash Relay			
LIGHT SENSORS					
Common Settings					
Light Immunity Lower Limit	10	10	25	klux	_____ klux
Arc Detection Time Before Tripping	0 (Effective 0.8)	1	10	ms	_____ ms
Light Sensor 1					
Sensor Status					<input type="checkbox"/> Sensor Present <input type="checkbox"/> No Sensor Detected <input type="checkbox"/> Sensor Missing <input type="checkbox"/> Sensor Tripped
Sensor Description		Sensor 1			
Change Configuration		No Change			<input type="checkbox"/> No Change <input type="checkbox"/> No Sensor Expected <input type="checkbox"/> Sensor Expected
Light Sensor 2					
Sensor Status					<input type="checkbox"/> Sensor Present <input type="checkbox"/> No Sensor Detected <input type="checkbox"/> Sensor Missing <input type="checkbox"/> Sensor Tripped
Sensor Description		Sensor 2			
Change Configuration		No Change			<input type="checkbox"/> No Change <input type="checkbox"/> No Sensor Expected <input type="checkbox"/> Sensor Expected
COMMON CONTROL BLOCK					
Trip Input					
Enabled		Enabled			<input type="checkbox"/> Enabled <input type="checkbox"/> Disabled
Trip Output					
Circuit Breaker Type		Shunt Coil (Trips When Powered)			Shunt Coil (Trips When Powered) <input type="checkbox"/> Undervoltage Coil (Closed While Powered)
ADVANCED					
Possibility To Reset Configuration And Drive – No Setup Parameters					
ALARMS					
Shows Currently Standing Alarms					

APPENDIX B REDUNDANT TRIP CIRCUIT DESCRIPTION

The AF0100 includes a redundant trip circuit which is active any time the CPU is not actively monitoring. Two conditions in which the CPU is not actively monitoring are during initialization (approximately 500ms following application of power) and in the extremely rare event that an internal CPU failure is detected.

When the CPU is active, it assumes control over the trip circuitry. When the CPU is inactive or initializing the AF0100 behaves as follows:

- Light Sensor Programmed Delay – the redundant trip circuit is hard wired and includes no delay, the programmed sensor delay is ignored
- Trip Relay Mode – the fail-safe/non-fail-safe setting is ignored, and trip relays operate in shunt or non-fail-safe mode, so a trip condition causes the trip relays to be energized
- Sensor Detection – sensor detection and failure reporting is inactive, but light intensity is monitored
- TRIP Input – the TRIP 1 and TRIP 2 relays are energized while the TRIP Input is active
- TRIPPED Output – the TRIPPED output is active while light is detected or while the TRIP Input is active
- RESET Input – the reset input is ignored
- RESET Button – the reset button is ignored
- ERROR Relay – the error relay is de-energized
- LEDs – all LEDs are off

NOTE: When under software control, the outputs operate in their configured operating mode (shunt trip or undervoltage trip). When controlled via redundant hardware, they are held statically as long as the sensor reports light over the threshold, and **will operate only in the shunt trip mode.**

**APPENDIX C
AF0100 REVISION HISTORY**

MANUAL RELEASE DATE	MANUAL REVISION	HARDWARE REVISION (REVISION NUMBER ON PRODUCT LABEL)	FIRMWARE REVISION
January 31, 2018	0-B-013118	0	1.00.02
December 5, 2017	0-B-120517		1.00.02
March 1, 2017	0-A-030117		1.00.01

MANUAL REVISION HISTORY

Revision 0-B-013118

Section 10.9

Updated warranty information.

Revision 0-B-120517

Section 10

Updated certification information.

Revision 0-A-030117

Initial release.

HARDWARE REVISION HISTORY

Hardware Revision 0

Initial release.

FIRMWARE REVISION HISTORY

Firmware Revision 1.00.02

The RESET function was corrected to properly reset an external TRIP.

Firmware Revision 1.00.01

Initial release.