

MM IN  
 20.57 .81  
 35.81 1.41  
 36.57 1.44

9577

APPLICABLE SAE STANDARD OR  
 RECOMMENDED PRACTICE SAE J259

2 KEYS - BRASS - SEE NOTE 2

FACE NUT  $\frac{3}{4}$  - 20 THREAD - SEE NOTE 1

PAL NUT

SCREW - SEMS - #8-32UNC

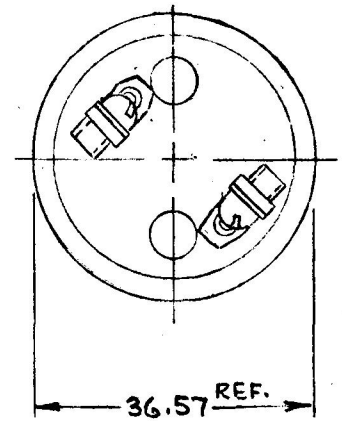
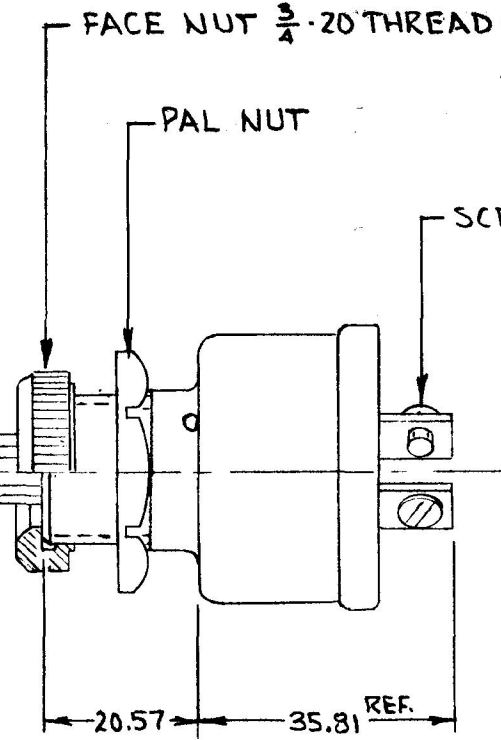
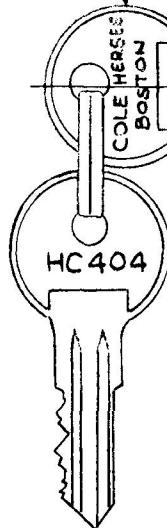
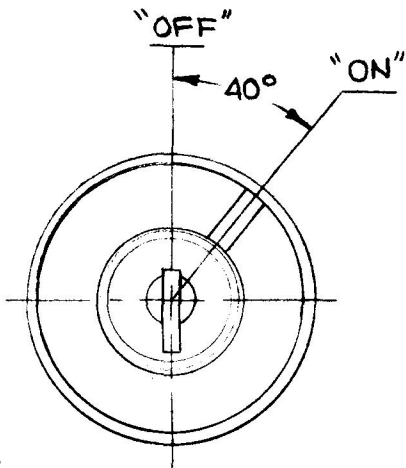

NOTES :

1. 8367 ADAPTER FACE NUT PERMITS ASS'Y OF SWITCH TO  $\frac{3}{4}$  &  $\frac{7}{8}$  DIA PANEL HOLES.
2. 250 KEY COMBINATIONS
3. ALL STEEL PARTS PLATED

METRIC 10AMPS @ 12V DC

DO NOT SCALE

LET.	WAS	DATE	BY	LET.	WAS	DATE	BY	MATERIAL	DRAWN	CHECKED	APPR'D	SCALE	DATE DRAWN
								<i>H</i>	AA	<i>SL</i>		1:1	12-11-57
								FINISH					DATE BLUEPRINT
								<i>H</i>					
				R	ADD METRICS	4-22-86	RJF	TOLERANCES					
				P	REDRAWN	12-5-86	ZU	DECIMAL ±					
								METRIC ±					
 20 OLD COLONY AVENUE SOUTH BOSTON MA. U.S.A. 02127												S.P.S.T. SWITCH	9577

CH-188(4-78)