

IN  
 0.25 0.010  
 0.17 0.004  
 0.79 0.030  
 0.57 0.020  
 0.37 0.015  
 0.00 0.000

APPLICABLE SAE STANDARD OR  
 RECOMMENDED PRACTICE SAE J259

LEVER, ZINC DIE CAST, CLEAR DICHROMATE W/P 95612-02

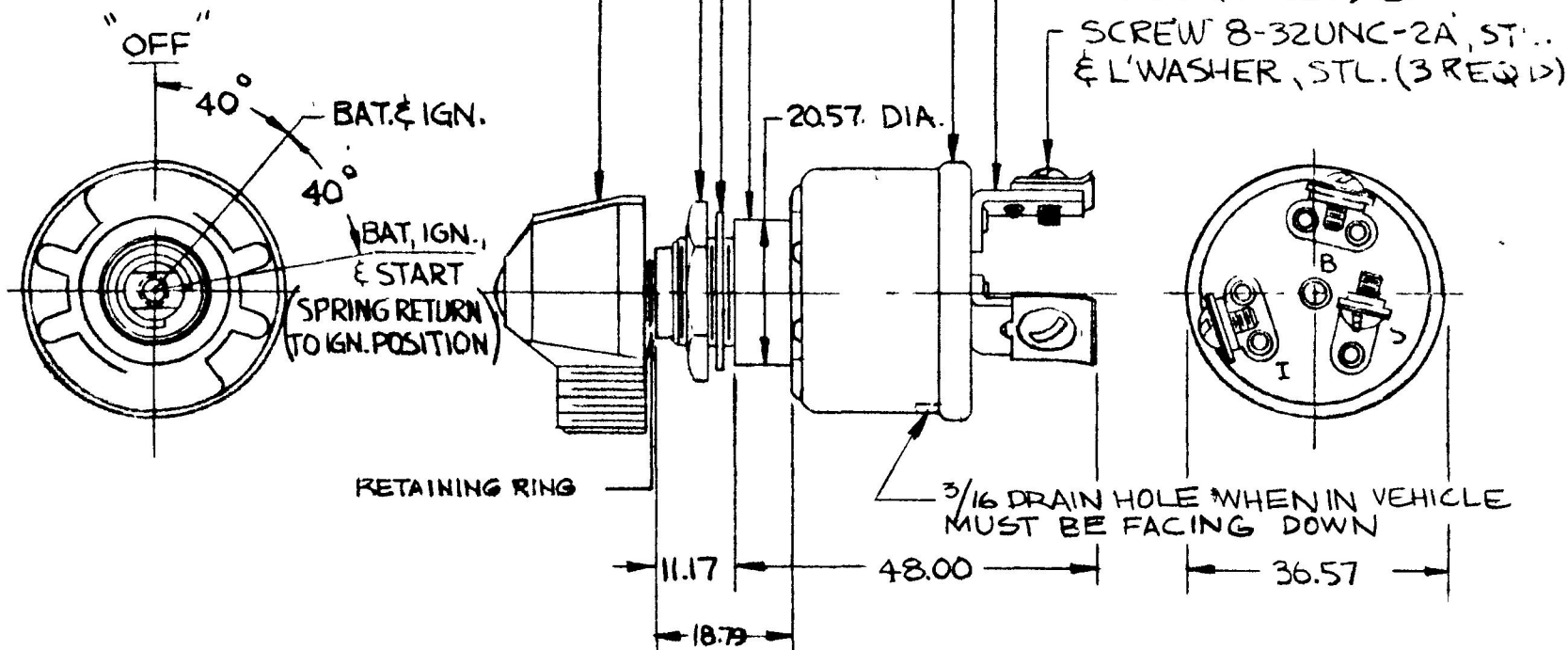

LEGEND	
I	IGNITION
S	START
B	BATTERY

START	20 AMPS
IGN	25 AMPS
RATING @ 12V DC	

NOTES

- 1 SILVER LAMINATED CONTACT SURFACES
- 2 MELAMINE LINER.
- ③ ALL STEEL PARTS PLATED

METRIC

4.0" RING SEALED AT BUSHING.

REV	WAS	DATE	BY	LET	WAS	DATE	BY	MATERIAL	DRAWN	CHECKED	APPRV'D	SCALE	DATE DRAWN
								NOTED	RO	<i>[Signature]</i>		FULL	5-2-89
								FINISH	<b>COLE-HERSEE COMPANY</b> BOSTON, MASS 02127, U.S.A.				DATE BLUEPRINT
							NOTED						
								TOLERANCES	HEAVY DUTY WEATHERPROOF 3 POS IGN & START SWITCH				95612-02
							FRACTIONAL ±						
								DECIMAL ±0.25					

COLE-HERSEE CO.

EX 23484