

MM IN  
 .25 .010  
 .76 .030  
 1.52 .060  
 2.03 .080  
 2.28 .090  
 3.55 .140  
 4.82 .190  
 9.14 .360  
 9.39 .370  
 13.71 .540  
 44.95 1.770  
 46.48 1.830

TSE-1034

EX 14258

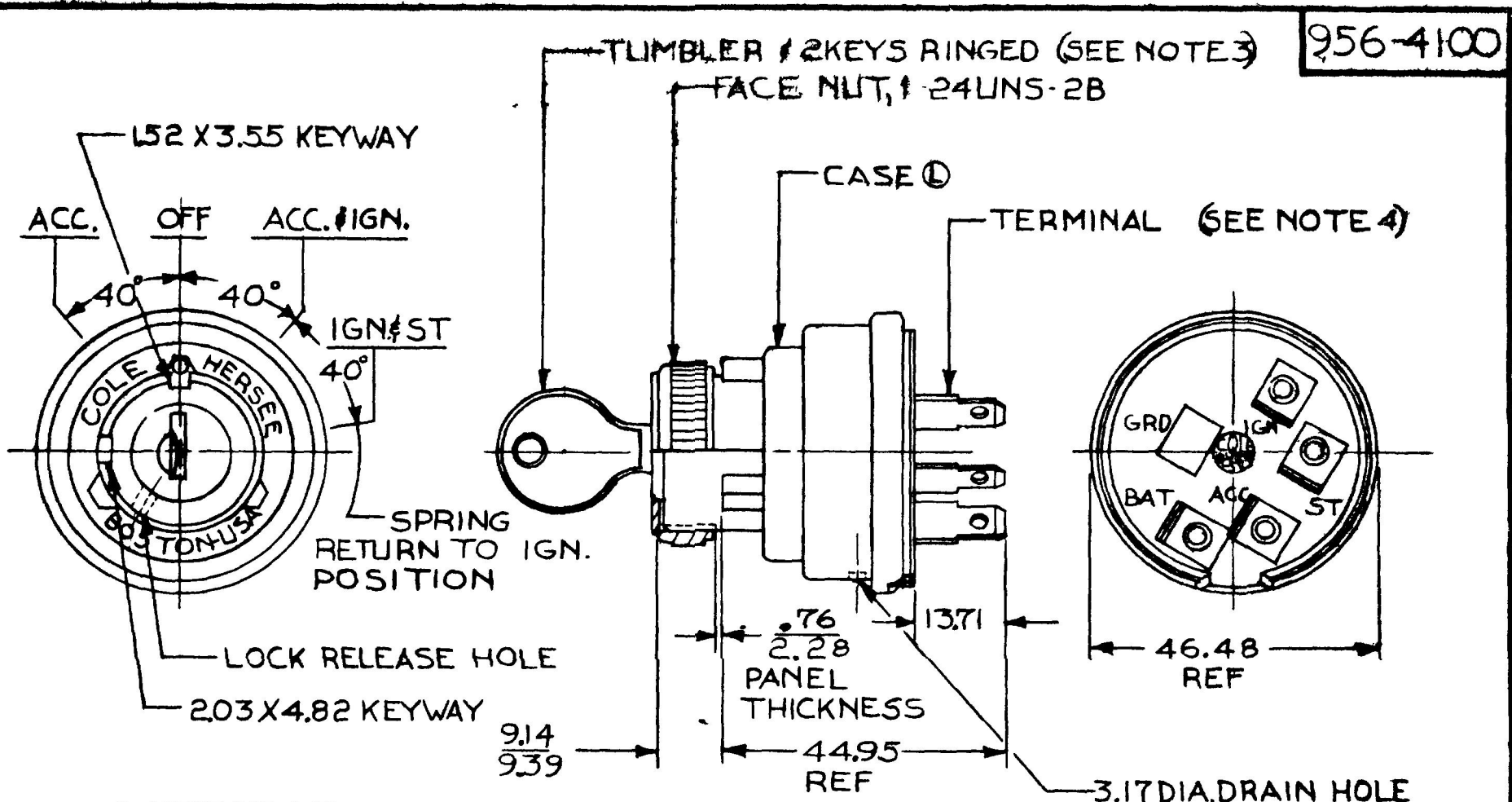

956-4100

METRIC

RATINGS AT 12VDC	
ACC. CIRCUIT	10 AMPS
IGN. "	10 "
ST. "	5 "

- NOTES:
1. APPLICABLE SAE STANDARD OR RECOMMENDED PRACTICE SAE J259
  2. LOCK REMOVABLE IN IGN. POSITION
  3. SHUTTER TYPE SEAL ON LOCK FACE
  4. TERMINALS ARRANGED TO FIT PACKARD CONNECTOR #2962912 OR EQUIV.

DO NOT SCALE

LET	WAS	DATE	BY	LET	WAS	DATE	BY	MATERIAL	DRAWN	CHECKED	APPR'D	SCALE	DATE DRAWN
								#	M.F.	4-28-80		1:1	2-24-66
								FINISH					DATE BLUEPRINT
								TOLERANCES	 30 OLD BOSTON AVENUE SOUTH BOSTON, MA U.S.A. 02127				
								DECIMAL ±					IGN & START SWITCH
								METRIC ± .05	(4 POSITION)	956-4100			

CH-1894-78)