

MM	IN
0.25	.010
0.38	.015
1.52	.060
7.11	.280
7.49	.295
7.56	.298
27.43	1.080
38.10	1.500
57.91	2.280

7112

CIRCUITRY	
PARK	PARK & TAIL LIGHT
LOW	LOW & TAIL LIGHT
HIGH	HIGH & TAIL LIGHT

10 AMPS MAX @ BATTERY CIRCUIT

COLE-HERSEE CO.

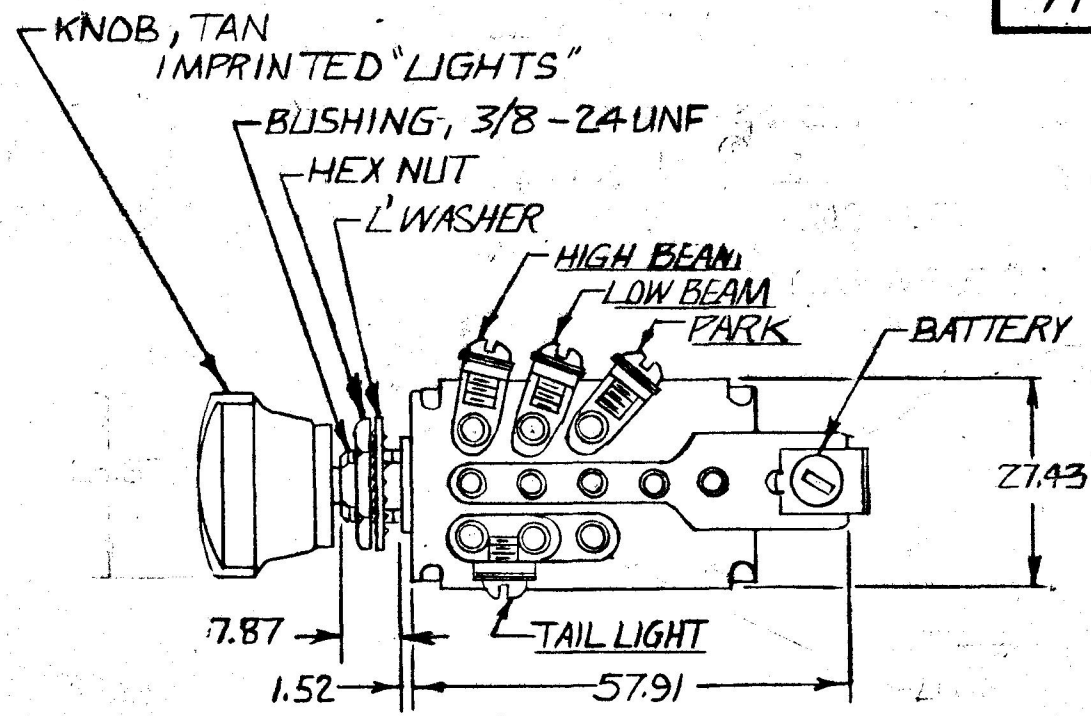
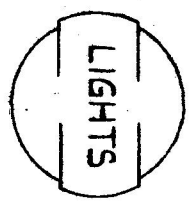

7.49
7.56

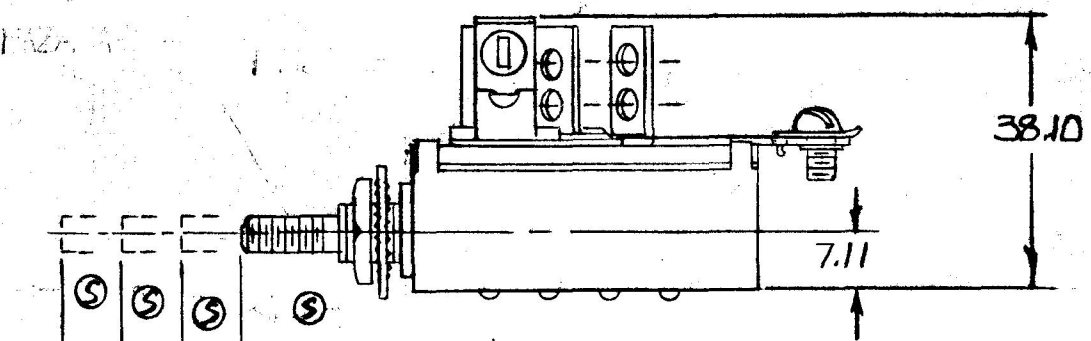
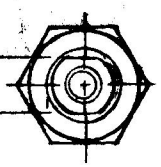

NOTE: ALL STEEL PARTS PLATED

METRIC

DO NOT SCALE

LET	WAS	DATE	BY	LET	WAS	DATE	BY	MATERIAL	DRAWN	CHECKED	APPR'D.	SCALE	DATE DRAWN
									EA	✓		FULL	12-14-62
				T	ADD CIRCUITRY & RATINGS (2233)	12-21-63	RJF	FINISH	COLE-HERSEE COMPANY BOSTON, MASS. 02127, U.S.A.				DATE BLUEPRINT
				S	REVISED SHAFT 21312	7-24-61	Ⓢ						
				R	REV/20975	10-14-61	Ⓢ	TOLERANCES	4 POSITION HEADLAMP SWITCH ASS'Y				7112
				Q	ADD METRICS	6/16/67	DK	FRACTIONAL ±0.38 DECIMAL ±0.25					