

MM	IN
7.11	0.280
12.70	
30.48	1.204
51.81	2.110
53.84	2.120
65.27	2.570
72.39	2.850
87.12	3.430

24022

© 12.70 x 7.11 ELONGATED HOLE
2 REQ'D

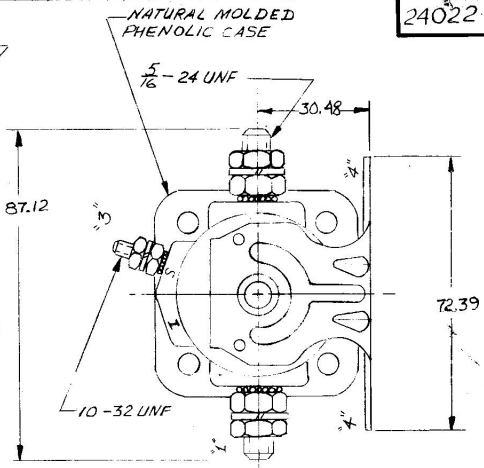
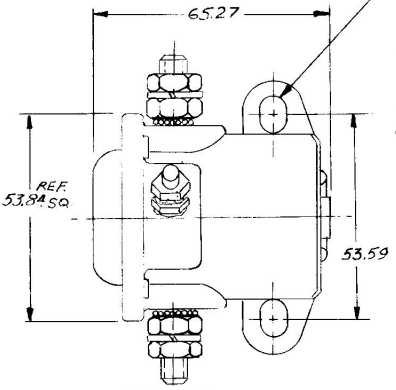

NATURAL MOLDED
PHENOLIC CASE

CIRCUIT
DIAGRAM

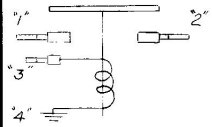

12 VOLT

METRIC

NOTE:

- ① 1. ALL STEEL PARTS PLATED.
- 2. 12 VDC, INTERMITTENT DUTY
COIL RESISTANCE: 3.8 OHM ± 5%

Confidential Property of Cole Hersee

DO NOT SCALE

LET.	WAS	DATE	BY	LET.	WAS	DATE	BY	MATERIAL	DRAWN	CHECKED	APPROV.	SCALE	DATE DRAWN
				D	ECN # 04280	8-4-04	SA	—	RJF	T.N.		FULL	8-11-86
				C	ECN # 26337	10/17/96	HP	FINISH					DATE BLUEPRINT
				B	24022.05/23605	10-13-87	AF	—					
				A	24022	8-13-86	AF	TOLERANCES					
					ISSUED	8-13-86	A	DECIMAL ±	SOLENOID (GROUNDED)			24022	
							METRIC ±						

CH Cole Hersee Co.
3412 CH ST. WILSON, SOUTH CAROLINA 29375

SOLENOID (GROUNDED)

24022

BRUNING 40-21 63765