

MM IN.  
 7.11 .28  
 12.70 .50  
 29.21 1.15  
 53.85 2.12  
 55.88 2.20  
 63.50 2.50  
 72.90 2.87  
 94.74 3.73

Confidential Property of Cole Hersee

24021

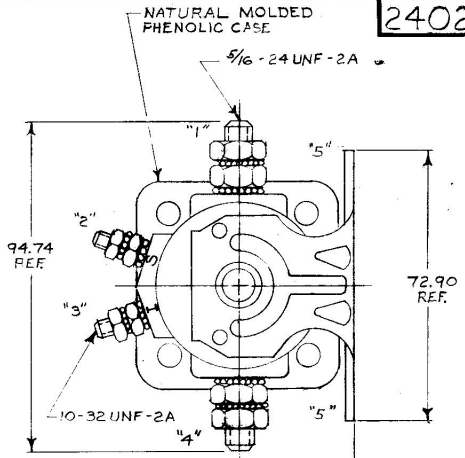
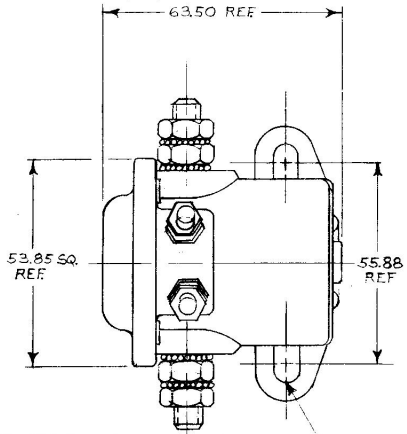

CIRCUIT DIAGRAM

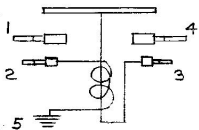

12.70 x 7.11 ELONGATED HOLE (2)

METRIC

NOTES:  
 1. ALL STEEL PARTS PLATED.  
 2. POSITIONS 1, 3, 4 ARE IN CONTACT SIMULTANEOUSLY WHEN CIRCUIT IS CLOSED.  
 3. 12 VOLTS GROUND TO BRACKET, INTERMITTENT DUTY.  
 (H) A. COIL RESISTANCE: 3.8 OHM ± 5%

DO NOT SCALE

LET.	WAS	DATE	BY	LET.	WAS	DATE	BY	MATERIAL	DRAWN	CHECKED	APPROVD.	SCALE	DATE DRAWN
									GH			1:1	5-8-56
								FINISH					DATE BLUEPRINT
									<b>CH</b> Cole Hersee Co. <small>1000 COLONY AVENUE, SOUTH BRIDGE, MA, U.S.A. 01107</small>				
								TOLERANCES	SOLENOID			24021	
								DECIMAL ±					
								METRIC ± .25					